

GUIDE TO CONCRETE OVERLAYS

FOURTH EDITION



IOWA STATE UNIVERSITY
Institute for Transportation

NOVEMBER 2021

National Concrete Pavement
Technology Center



About the CP Tech Center

The mission of the National Concrete Pavement Technology Center (CP Tech Center) at Iowa State University is to unite key transportation stakeholders around the central goal of advancing concrete pavement technology through research, technology transfer, and technology implementation.

Notice

This document is disseminated under the sponsorship of the U.S. Department of Transportation in the interest of information exchange under Cooperative Agreement 693JJ31950004, Advancing Concrete Pavement Technology Solutions. The U.S. Government assumes no liability for the use of the information contained in this document.

The U.S. Government does not endorse products or manufacturers. Trademarks or manufacturers' names appear in this material only because they are considered essential to the objective of the document. They are included for informational purposes only and are not intended to reflect a preference, approval, or endorsement of any one product or entity.

Nonbinding Contents

The contents of this document do not have the force and effect of law and are not meant to bind the public in any way. This document is intended only to provide clarity to the public regarding existing requirements under the law or agency policies. However, compliance with applicable statutes or regulations cited in this document is required.

Quality Assurance Statement

The Federal Highway Administration (FHWA) provides high-quality information to serve Government, industry, and the public in a manner that promotes public understanding. Standards and policies are used to ensure and maximize the quality, objectivity, utility, and integrity of its information. FHWA periodically reviews quality issues and adjusts its programs and processes to ensure continuous quality improvement.

Iowa State University Nondiscrimination Statement

Iowa State University does not discriminate on the basis of race, color, age, ethnicity, religion, national origin, pregnancy, sexual orientation, gender identity, genetic information, sex, marital status, disability, or status as a US veteran. Inquiries regarding nondiscrimination policies may be directed to the Office of Equal Opportunity, 3410 Beardshear Hall, 515 Morrill Road, Ames, Iowa 50011, telephone: 515-294-7612, hotline: 515-294-1222, email: eooffice@iastate.edu.

About This Guide

The *Guide to Concrete Overlays* is a product of the National Concrete Pavement Technology Center (CP Tech Center) at Iowa State University, with funding from the Federal Highway Administration (FHWA). This guide presents the basic principles needed to design and construct concrete overlays on existing asphalt, composite, and concrete pavements. It is the fourth edition of the *Guide to Concrete Overlays* since 2007. Complementary publications developed by the CP Tech Center include *Guide Specifications for Concrete Overlays* (2016), *Guide for the Development of Concrete Overlay Construction Documents* (2018), *Concrete Pavement Preservation Guide* (new edition forthcoming), and *History of Concrete Overlays in the United States* (new edition forthcoming). These and other publications related to concrete overlays are available on the CP Tech Center's website, <https://cptechcenter.org/>.

Reference Information for this Guide

Fick, G., J. Gross, M. B. Snyder, D. Harrington, J. Roesler, and T. Cackler. 2021. *Guide to Concrete Overlays*. 4th Edition. National Concrete Pavement Technology Center, Iowa State University, Ames, IA.

For More Information

National Concrete Pavement Technology Center
Iowa State University Research Park
2711 S. Loop Drive, Suite 4700
Ames, IA 50010-8664
515-294-5798
<https://cptechcenter.org/>

Cover Image Credits

Todd LaTorella, ACPA, MO/KS Chapter, used with permission

Technical Report Documentation Page

1. Report No.	2. Government Accession No.	3. Recipient's Catalog No.	
4. Title and Subtitle <i>Guide to Concrete Overlays</i> (Fourth Edition)		5. Report Date November 2021	
		6. Performing Organization Code	
7. Author(s) Gary Fick, Jerod Gross, Mark B. Snyder, Dale Harrington, Jeffery Roesler, and Tom Cackler		8. Performing Organization Report No.	
9. Performing Organization Name and Address National Concrete Pavement Technology Center Iowa State University 2711 South Loop Drive, Suite 4700 Ames, IA 50010-8664		10. Work Unit No.	
		11. Contract or Grant No. Part of Cooperative Agreement 693JJ31950004, Advancing Concrete Pavement Technology Solutions	
12. Sponsoring Organization Name and Address Federal Highway Administration 1200 New Jersey Avenue, SE Washington, DC 20590		13. Type of Report and Period Covered Guide	
		14. Sponsoring Agency Code	
15. Supplementary Notes Visit https://cptechcenter.org for color pdfs of this and other research publications.			
16. Abstract <p>This guide presents the basic principles that a pavement engineer needs to design and construct concrete overlays on existing asphalt, composite, and concrete pavements.</p> <p>The intent of this guide is to increase the technical proficiency of experienced engineers in the use of concrete overlays, provide less experienced users with the essential knowledge to address the needs of various types of concrete overlay projects, and help all users recognize the versatility of concrete overlays, whether on low-volume roads, city streets, primary roadways, or Interstate highways. Rather than as a step-by-step manual or series of prescriptive formulae, the material in this guide is presented in the form of expert guidance meant to supplement the professional experience of the reader.</p> <p>This fourth edition of the guide has been updated with current information on continuously reinforced concrete pavement overlays, geotextile separation layers, fiber reinforcement, concrete overlay design procedures, and lessons learned from the experiences of numerous state highway agency engineers.</p>			
17. Key Words concrete overlays—pavements—pavement preservation—pavement rehabilitation—resurfacing		18. Distribution Statement No restrictions.	
19. Security Classification (of this report) Unclassified.	20. Security Classification (of this page) Unclassified.	21. No. of Pages 152	22. Price NA

Guide to Concrete Overlays

(Fourth Edition)

November 2021

Authors

Gary Fick, The Transtec Group, Inc.

Jerod Gross, PE, LEED AP, Snyder & Associates, Inc.

Mark B. Snyder, PhD, PE, Pavement Engineering and Research Consultants, LLC

Dale Harrington, PE, Harrington Civil Engineering Services

Jeffery Roesler, PhD, PE, University of Illinois at Urbana-Champaign

Tom Cackler, PE, Woodland Consulting, Inc.

Project Manager

Steven L. Tritsch, PE, National Concrete Pavement Technology Center, Iowa State University

Managing Editor

Oksana Gieseeman

Editor

Peter Hunsinger

Graphic Design, Layout, and Production

Alicia Hoermann

A guide from
National Concrete Pavement Technology Center
Iowa State University
2711 South Loop Drive, Suite 4700
Ames, IA 50010-8664
Phone: 515-294-5798 / Fax: 515-294-0467
<https://cptechcenter.org>

Acknowledgments

The CP Tech Center gratefully acknowledges the generous financial support of the FHWA for the development of the fourth edition of this guide. The CP Tech Center and the authors also wish to thank the following knowledgeable, experienced, and dedicated concrete pavement experts who served on the Technical Advisory Committee and contributed to the development of this guide:

- Andy Bennett, Michigan Department of Transportation
- Mike Byers, PE, American Concrete Pavement Association, Indiana Chapter
- Dan DeGraaf, PE, Michigan Concrete Association
- Angela Folkestad, PE, American Concrete Pavement Association, Colorado/Wyoming Chapter
- Todd Hanson, PE, Iowa Department of Transportation
- Mike Praul, PE, Federal Highway Administration
- Sam Tyson, PE, Federal Highway Administration
- Jeff Uhlmeyer, PE, Quality Engineering Solutions
- Leif Wathne, PE, American Concrete Pavement Association
- Matt Zeller, PE, Concrete Paving Association of Minnesota
- Gordon Smith, PE, National Concrete Pavement Technology Center
- John Adam, PE, National Concrete Pavement Technology Center

Abbreviations

3D	three-dimensional	JPCP	jointed plain concrete pavement
AASHTO	American Association of State Highway and Transportation Officials	JRCP	jointed reinforced concrete pavement
ACI	American Concrete Institute	LCCA	life-cycle cost analysis
ACPA	American Concrete Pavement Association	LiDAR	light detection and ranging
ASR	alkali-silica reactivity	LTPP	Long-Term Pavement Performance
ASTM	American Society for Testing and Materials	MEPDG	Mechanistic-Empirical Pavement Design Guide
COA-B	concrete on asphalt-bonded	MOR	modulus of rupture
COA-U	concrete on asphalt-unbonded	MRD	materials-related distress
COC-B	concrete on concrete-bonded	NCHRP	National Cooperative Highway Research Program
COC-U	concrete on concrete-unbonded	NPV	net present value
CP Tech Center	National Concrete Pavement Technology Center	NRMCA	National Ready-Mixed Concrete Association
CRCP	continuously reinforced concrete pavement	PEM	performance-engineered mixtures
CTE	coefficient of thermal expansion	SAM	Super Air Meter
ESAL	equivalent single axle load	PAMS	poly alpha-methylstyrene
FEA	finite element analysis	PASSRC	permeable asphalt-stabilized stress relief course
FHWA	Federal Highway Administration	PCA	Portland Cement Association
FRC	fiber-reinforced concrete	PCC	portland cement concrete
FRP	fiber-reinforced polymer	SCM	supplementary cementitious material
HMA	hot-mix asphalt	SHA	state highway agency
IMCP	Integrated Materials and Construction Practices	SJPCP	short-jointed plain concrete pavement
IRI	International Roughness Index	w/cm ratio	water-to-cementitious materials ratio

Contents

Chapter 1

Introduction	1
Purpose and Scope.....	2
How to Use This Guide.....	2
Benefits and Historical Performance of Concrete Overlays.....	2
Asset Management through the Use of Concrete Overlays.....	3
Concrete Overlay Options.....	4
Construction and Quality Assurance of Concrete Overlays.....	5

Chapter 2

Evaluation of Existing Pavements and Selection of Concrete Overlay Options.....7

Determining the Feasibility of a Concrete Overlay and Selecting the Appropriate Design.....	8
Step 1. Determine the Existing Pavement Type and Condition.....	8
Step 2. Make a Preliminary Determination of the Existing Typical Section Layers and Thicknesses.....	8
Step 3. Conduct an On-Site Review and Evaluation..11	
Existing Pavement Distresses.....	11
Drainage Conditions.....	11
Support Conditions.....	11
Vertical Constraints.....	11
Existing Shoulders and Widened Sections.....	12
Step 4. Determine the Need for Milling and Accommodating Adjustments of the Profile Grade..12	
Milling.....	12
Roadway and Roadside Constraints on Vertical Change in Profile Grade.....	12
Step 5. Verify the Existing Pavement Condition: Coring and Material Testing.....	13
Step 6. Determine the Feasibility of a Concrete Overlay and the Appropriate Overlay Option.....	13
Next Steps.....	14

Chapter 3

Overview of Concrete Overlay Design	15
Concrete Overlay Thickness Design.....	16
Typical Thickness Design Inputs and Considerations..	16

Overview of Common Concrete Overlay Design Procedures.....	17
Key Design Considerations.....	17
Design Considerations for All Concrete Overlays...17	
Need for Uniform Support.....	17
Use of Macrofibers.....	17
Joint Activation.....	18
Design Considerations for Concrete on Concrete–Unbonded Overlays.....	18
Pre-overlay Repairs.....	18
Panel Dimensions and Joint Layout.....	18
Transverse Joints: Dowel Bars, Macrofibers, and Sawcuts.....	18
Longitudinal Joints: Location and Sawcuts.....	18
Joint Filling and Sealing.....	19
Special Considerations for Continuously Reinforced Concrete Pavement Overlays.....	19
Design Considerations for Concrete on Asphalt–Unbonded Overlays.....	19
Pre-overlay Repairs.....	19
Panel Dimensions, Joint Layout and Design, and Joint Sealing.....	20
Special Considerations for Continuously Reinforced Concrete Pavement Overlays.....	20
Design Considerations for Concrete on Asphalt–Bonded Overlays.....	20
General Design Considerations.....	20
Special Considerations for Continuously Reinforced Concrete Pavement Overlays.....	20
Design Considerations for Concrete on Concrete–Bonded Overlays.....	20
General Design Considerations.....	20
Special Considerations for Continuously Reinforced Concrete Pavement Overlays.....	21
Additional Design Considerations to Address Impacts of Profile and Grade Changes.....	21
Overhead Clearance.....	21
Shoulder Considerations.....	21
Barriers and Rails.....	21
Foreslopes, Backslopes, and Across-Road Drainage Structures.....	21

Widening and Lane Additions.....	21	Water.....	44
In-Place Structures.....	23	Admixtures.....	44
Curb and Gutter Details.....	23	Performance-Engineered Mixture Properties for Overlays.....	45
Transitions.....	23	Strength.....	45
		Workability.....	45
		Shrinkage.....	45
		Cold Weather Resistance.....	45
		Water-to-Cementitious Materials Ratio.....	46
		Opening Criteria for Concrete Overlays.....	46
		Other Overlay Materials.....	47
		Macrofibers for Concrete Overlays.....	47
		Macrofiber Material Types.....	47
		Effects of Macrofibers on the Fresh and Hardened Properties of Concrete.....	49
		Separation Layer.....	50
		Asphalt Separation Layer.....	50
		Nonwoven Geotextile Separation Layer.....	50
		Dowel Bars and Tie Bars.....	51
		Curing Compound.....	51
		Joint Fillers and Sealants.....	51
Chapter 4		Chapter 7	
Concrete Overlays on Asphalt-Surfaced Pavements.....	25	Plan Development.....	53
Concrete on Asphalt–Unbonded Overlays.....	26	Construction Drawings.....	54
Application and Uses.....	27	Title Sheet.....	55
Performance.....	27	Typical Sections.....	55
Keys to Success.....	27	Estimated Quantities.....	56
Pavement Evaluation.....	27	Plan and Profile.....	56
Overlay Design.....	28	Survey Control Information.....	57
Construction.....	28	Maintenance of Traffic.....	57
Maintenance and Repairs.....	29	Accelerated Construction.....	58
Concrete on Asphalt–Bonded Overlays.....	29	Staging under Traffic.....	60
Application and Uses.....	30	Typical Construction Details.....	60
Performance.....	30	Jointing.....	60
Keys to Success.....	30	Pavement Widening.....	61
Pavement Evaluation.....	30	Profile Transitions.....	61
Overlay Design.....	31	Details for Overlays in Urban Areas.....	63
Construction.....	31	Curb and Gutter Details.....	63
Maintenance and Repairs.....	33	Utility Access Details.....	64
Chapter 5			
Concrete Overlays on Concrete Pavements.....	35		
Concrete on Concrete–Unbonded Overlays.....	36		
Application and Uses.....	36		
Performance.....	37		
Keys to Success.....	37		
Pavement Evaluation.....	38		
Overlay Design.....	38		
Construction.....	39		
Maintenance and Repairs.....	41		
Concrete on Concrete–Bonded Overlays.....	41		
Chapter 6			
Materials and Mixtures.....	43		
Concrete Material Constituents.....	44		
Cementitious Materials.....	44		
Aggregates.....	44		

Miscellaneous Details.....	64
Safety Edge Detail.....	64
Superelevation Details.....	64
Special Considerations for Continuously Reinforced Concrete Pavement Overlays.....	65
Construction Specifications.....	65
Chapter 8	
Construction of Concrete Overlays.....	67
Pre-overlay Repairs.....	68
Milling (for Existing Asphalt-Surfaced Pavements).....	68
Subgrade/Subbase Repairs.....	69
Full-Depth Repairs of Existing Concrete Pavement.....	69
Full-Depth Repairs of Existing Asphalt Pavement.....	69
Full-Depth Repairs of Existing Composite Pavement.....	70
Repair of Thermal Cracking in Existing Asphalt Pavement.....	70
Repair of Deteriorated Joints in Existing Concrete Pavement.....	70
Separation Layer (for Concrete on Concrete– Unbonded Overlays).....	70
Asphalt Separation Layer.....	70
Nonwoven Geotextile Separation Layer.....	71
Other Considerations for Separation Layers.....	72
Concrete Overlay Placement.....	72
Construction Staking and Machine Control.....	72
Final Surface Preparation.....	72
Placing Dowel Baskets.....	73
Concrete Overlay Curing.....	73
Concrete Overlay Joints.....	74
Sawing Joints.....	74
Sealing Joints.....	75
Opening the Overlay to Traffic.....	75
Determining Opening Time.....	75
Minimizing Early Loading Fatigue Damage.....	75
Repairs of Concrete Overlays.....	75
Repairs of Unbonded Concrete Overlays 7 in. Thick or Greater.....	76
Repairs of Bonded or Unbonded Concrete Overlays Less than 6 in. Thick.....	76
Special Construction Considerations for Concrete on Concrete–Bonded Overlays.....	77

Appendix A

Fundamentals of Concrete Overlay Design.....	79
Overview of Concrete Overlay Design.....	80
Concrete Overlay Thickness Design.....	80
Typical Thickness Design Inputs and Considerations.....	80
Selection of a Thickness Design Procedure.....	80
Empirical versus Mechanistic-Empirical Design Procedures.....	80
Designing for Bonded versus Unbonded Interface Conditions.....	81
Overview of Common Concrete Overlay Design Procedures.....	82
AASHTOWare Pavement ME Design.....	82
PavementDesigner.org.....	83
University of Pittsburgh’s BCOA-ME.....	83
University of Pittsburgh’s UNOL Design v1.0.....	83
Key Design Considerations.....	84
Design Considerations for All Concrete Overlays ..85	
Need for Uniform Support.....	85
Use of Macrofibers.....	85
Joint Activation.....	85
Design Considerations for Concrete on Concrete– Unbonded Overlays.....	85
Pre-overlay Repairs.....	85
Selection of a Separation Layer.....	86
Panel Dimensions and Joint Layout.....	86
Transverse Joints: Dowel Bars, Macrofibers, and Sawcuts.....	87
Longitudinal Joints: Tie Bars, Macrofibers, and Sawcuts.....	88
Joint Filling and Sealing.....	88
Special Considerations for Continuously Reinforced Concrete Pavement Overlays.....	88
Design Considerations for Concrete on Asphalt– Unbonded Overlays.....	89
Pre-overlay Repairs.....	89
Separation Layer Selection Considerations.....	89
Panel Dimensions, Joint Layout and Design, and Joint Sealing.....	89
Special Considerations for Continuously Reinforced Concrete Pavement Overlays.....	90

Design Considerations for Concrete on Asphalt– Bonded Overlays.....	90
Foundation Support Characterization.....	90
Pre-overlay Repairs.....	91
Overlay Material Selection.....	91
Achievement and Maintenance of a Bond.....	91
Maximum Overlay Thickness.....	91
Panel Dimensions and Joint Layout.....	91
Dowel Bars, Tie Bars, and Use of Fiber-Reinforced Concrete.....	92
Reflective Cracking.....	93
Joint Filling and Sealing.....	93
Special Considerations for Continuously Reinforced Concrete Pavement Overlays.....	93
Design Considerations for Concrete on Concrete– Bonded Overlays.....	93
Pre-overlay Repairs.....	94
Overlay Materials.....	94
Achievement and Maintenance of a Bond.....	94
Jointing Practices.....	94
Dowels and Tie Bars.....	95
Joint Filling.....	95
Special Considerations for Continuously Reinforced Concrete Pavement Overlays.....	95
Additional Design Considerations to Address Impacts of Profile and Grade Changes.....	95
Overhead Clearance.....	96
Shoulder Considerations.....	96
Barriers and Rails.....	96
Foreslopes, Backslopes, and Across-Road Drainage Structures.....	96
Safety Edge.....	96
Widening and Lane Additions.....	97
In-Place Structures.....	98
Curb and Gutter Details.....	98
Transitions.....	98

Appendix B	
Continuously Reinforced Concrete Pavement Overlays.....	99
Applications and Performance.....	100
Continuously Reinforced Concrete Pavement Overlays of Asphalt-Surfaced Pavements.....	101
Continuously Reinforced Concrete Pavement Overlays on Concrete Pavements.....	102
Unbonded CRCP Overlays on Concrete Pavements..	102
Bonded CRCP Overlays on Concrete Pavements....	105
Evaluation of the Existing Pavement Structure.....	105
Design.....	106
Materials and Concrete Mixtures.....	106
Concrete Mixtures.....	106
Reinforcing Steel.....	106
Separation Layer (for Unbonded Overlays).....	106
Construction.....	106
Pre-overlay Repairs.....	107
Terminal or End Treatment Joints.....	107
Life-Cycle Cost Analysis of Continuously Reinforced Concrete Pavement Overlays.....	108
Scenario.....	108
Principles and Parameters.....	110
Results.....	111

Appendix C	
Concrete on Concrete–Bonded Overlays.....	113
Key Features and Applications.....	114
Evaluation of Existing Pavement Structures.....	115
Design Features.....	116
Bond.....	116
Mixture Design.....	116
Thickness Design.....	117
Joint Spacing and Layout.....	117
Drainage.....	117

Construction.....	117
Pre-overlay Repairs.....	117
Surface Preparation.....	118
Surface Cleaning.....	118
Concrete Placement.....	118
Curing.....	119
Joint Sawing.....	119
Joint Sealing.....	119
Opening Strength.....	119
Case Studies of Concrete on Concrete–Bonded Overlays.....	120
Case Study 1: Thin (3 in.) Bonded Overlay on Iowa 3 East of Hampton, Iowa.....	120
Case Study 2: Thin (3 in.) Bonded Overlay on 15th Street in Del City, Oklahoma.....	121
Appendix D	
Staging Sequence Diagrams for Various Traffic Control Scenarios.....	123
Two-Lane Roadway with Paved Shoulders (Conventional Paver).....	124
Two-Lane Roadway with Granular Shoulders (Conventional Paver).....	126
Two-Lane Roadway with Minimum Granular Shoulders (Zero-Clearance Paver).....	128
Two-Lane Roadway Widened to Three Lanes with Paved Shoulders (Conventional Paver).....	130
Four-Lane Roadway with Paved Shoulders (Conventional Paver).....	132
References.....	135

Figures

Chapter 1

Figure 1.1. Unbonded concrete overlay with geotextile interlayer on Missouri Route D (top, in 2007 before overlay construction; bottom, in 2020 after 12 years of service).....2

Figure 1.2. Concrete overlays in 46 states (overlays constructed 1901–1999/overlays constructed 2000–2017).....3

Figure 1.3. Typical bonded and unbonded concrete overlay solutions at various stages of pavement service life.....4

Figure 1.4. Four main types of concrete overlays.....5

Chapter 2

Figure 2.1. Examples of determining existing pavement type and condition.....9

Figure 2.2. General guidance for rating the condition of concrete pavement.....10

Figure 2.3. General guidance for rating the condition of asphalt and composite pavement.....10

Figure 2.4. Blending safety slopes to existing conditions.....13

Figure 2.5. Regrading safety slopes and extending drainage structures.....13

Figure 2.6. Determining the appropriate design strategy for a given project.....14

Chapter 3

Figure 3.1. Behavior of and flexural stress distribution through the layers of bonded and unbonded overlay systems.....17

Figure 3.2. Concrete overlay on composite pavement photographed in 2012 after 13 years in service, with the overlay exhibiting interior corner deterioration due to longitudinal joints in the wheel paths.....19

Figure 3.3. Concrete overlay widening on Illinois Route 53 with no longitudinal joint or reinforcing over existing pavement edge (top); concrete overlay widening on Minnesota TH 212 with longitudinal joints and reinforcing over existing pavement edge in some locations (center) and only reinforcing in other locations (bottom).....22

Chapter 4

Figure 4.1. Bonded and unbonded overlays of existing asphalt and composite pavements.....	26
Figure 4.2. COA–U overlays on existing asphalt (left) and composite (right) pavements.....	26
Figure 4.3. Unbonded on asphalt.....	27
Figure 4.4. Unbonded on composite.....	27
Figure 4.5. COA–B overlays on existing asphalt (left) and composite (right) pavements.....	29
Figure 4.6. Bonded on asphalt.....	30
Figure 4.7. Bonded on composite.....	30
Figure 4.8. Placement of reinforcing steel over a crack in an existing asphalt-surfaced pavement.....	32

Chapter 5

Figure 5.1. Bonded and unbonded overlays of existing concrete pavements.....	36
Figure 5.2. COC–U overlay.....	36
Figure 5.3. Route D existing concrete in deteriorated condition in 2007 (top); 5 in. unbonded overlay constructed on Route D in 2008 (bottom, photo taken in 2020).....	37
Figure 5.4. COC–B overlay.....	41

Chapter 6

Figure 6.1. Reflective cracking in an overlay without fibers (top) and in an overlay containing macrofibers (bottom).....	48
Figure 6.2. Types of macrofibers: (a-c) crimped, embossed, or bi-tapered synthetic; (d) twisted synthetic; (e-f) straight fibrillated synthetic; and (g-h) hooked end and crimped steel.....	48
Figure 6.3. Synthetic macrofibers.....	48
Figure 6.4. Surface texture of concrete overlay with synthetic macrofibers.....	48
Figure 6.5. Post-cracking behavior of a notched FRC beam specimen containing synthetic macrofibers.....	49
Figure 6.6. Dark-colored nonwoven geotextile separation layer.....	50
Figure 6.7. Light-colored nonwoven geotextile separation layer.....	50

Chapter 7

Figure 7.1. Title sheet.....	55
Figure 7.2. Unbonded concrete overlay on concrete with widening (paved shoulders).....	56
Figure 7.3. Estimated quantities sheet.....	57

Figure 7.4. Survey control information sheet.....	58
Figure 7.5. Sheet outlining traffic control and staging notes.....	59
Figure 7.6. Plan view joint layout detail for an unbonded overlay with widening.....	60
Figure 7.7. COC–B joint detail showing the widths of the overlay joint, sawcut, and underlying crack.....	61
Figure 7.8. Widening details for COC–B and COA–B overlays.....	62
Figure 7.9. Widening details for COC–U and COA–U overlays.....	62
Figure 7.10. Mill and fill profile transitions for bonded concrete overlays on end transition.....	63
Figure 7.11. Transition for a COA–B overlay.....	63
Figure 7.12. Temporary transitions.....	63
Figure 7.13. Transition for a COA–U overlay.....	63
Figure 7.14. Three options for curb and gutter details.....	63
Figure 7.15. Utility access detail.....	64
Figure 7.16. Safety edge detail.....	64
Figure 7.17. Superelevation detail.....	64

Chapter 8

Figure 8.1. Milling to remove severe rutting.....	68
Figure 8.2. Core showing pavement that can be milled to remove stripped/unsound material, with 4 in. of HMA remaining in good condition.....	68
Figure 8.3. Asphalt surface milled to enhance bonding with a concrete overlay.....	69
Figure 8.4. Area where the milling and concrete overlay depths are to be adjusted to address isolated locations where the remaining pavement depth is inadequate.....	69
Figure 8.5. Deteriorated joints in existing concrete pavement cleaned and filled with flowable mortar.....	70
Figure 8.6. Overlapping sections of nonwoven geotextile material.....	71
Figure 8.7. Use of adhesive to secure geotextile fabric to an existing pavement.....	71
Figure 8.8. Stringless paving, with lateral clearance primarily a function of paver track width.....	72
Figure 8.9. Dowel basket anchor nails placed on the downstream side of the basket relative to the direction of paving.....	73
Figure 8.10. Manual verification of dowel placement.....	73
Figure 8.11. Comparison of sawcutting needed for overlays of different thicknesses and slab sizes.....	74
Figure 8.12. Removal of overlay panels.....	76

Figure 8.13. Finishing and curing of a concrete overlay repair.....	76
Figure 8.14. Typical concrete pavement milling operation in progress.....	76
Figure 8.15. Results of a typical concrete pavement milling operation.....	77

Appendix A

Figure A.1. Behavior of and flexural stress distribution through the layers of bonded and unbonded overlay systems.....	81
Figure A.2. Tie bars anchored to an existing pavement surface across a longitudinal edge joint where a concrete overlay will be used for a widening section.....	86
Figure A.3. Concrete overlay on composite pavement photographed in 2012 after 13 years in service, with the overlay exhibiting interior corner deterioration due to longitudinal joints in the wheel paths.....	87
Figure A.4. Impact of panel size on thermal and shrinkage restraint stress.....	91
Figure A.5. COA-B overlay with tied lane joints and untied mid-lane longitudinal joint after eight years of service.....	92
Figure A.6. Schematic of a sawcut for a COC-B overlay.....	94
Figure A.7. Double-crack resulting from failure to match the sawcut with the underlying joint location in a COC-B overlay.....	94
Figure A.8. COC-B overlay on US 119 in Pennsylvania with 12.3 ft long panels constructed in 2014 on JRCP with 61.5 ft long panels: project overview (top) and exposed longitudinal joint at intermediate transverse joint (bottom).....	95
Figure A.9. Concrete overlay widening on Illinois Route 53 with no longitudinal joint or reinforcing over existing pavement edge (top); concrete overlay widening on Minnesota TH 212 with longitudinal joints and reinforcing over existing pavement edge in some locations (center) and only reinforcing in other locations (bottom).....	97

Appendix B

Figure B.1. CRCP overlays being placed on I-70 in 2002 (top) and on I-57/I-64 in 2013 (bottom).....	100
Figure B.2. Transition slab details for an end treatment of a CRCP overlay at a bridge.....	107
Figure B.3. Transition slab details for an end treatment of a CRCP overlay at a JPCP.....	108
Figure B.4. Transition slab details for the end treatment and terminal joints of a CRCP overlay.....	109

Figure B.5. Net present value of CRCP and JPCP overlay designs for various discount rates.....	111
Figure B.6. Net present value of CRCP and JPCP overlay designs for a discount rate of 3.0% and various steel prices.....	111

Appendix C

Figure C.1. Thin bonded overlay of structurally sound concrete pavement.....	114
Figure C.2. Deteriorated longitudinal crack in a COC-B overlay.....	114
Figure C.3. Existing concrete pavement with minor surface distresses shown with a proposed COC-B overlay.....	115
Figure C.4. Process for determining an appropriate overlay solution.....	116
Figure C.5. Cross section of a transverse saw joint in a COC-B overlay.....	117
Figure C.6. Shotblasting of a concrete surface.....	118
Figure C.7. Use of compressed air to clean existing concrete in front of the paver.....	118
Figure C.8. Placement of a thin COC-B overlay.....	118
Figure C.9. Existing concrete pavement in 1994 prior to overlay placement, with a shotblaster in operation and some spot spalling evident at the centerline joint.....	120
Figure C.10. Reinforcement over transverse cracks in the existing concrete pavement prior to overlay placement 1994.....	120
Figure C.11. East end of the COC-B overlay on Iowa 3 in August 2021, showing pavement in fair to good condition.....	120
Figure C.12. West end of the COC-B overlay on Iowa 3 in August 2021.....	120
Figure C.13. Existing 3 in. thick asphalt overlay on 15th Street prior to milling.....	121
Figure C.14. Existing concrete on 15th Street after milling the 3 in. thick asphalt overlay.....	121
Figure C.15. U-shaped No. 5 tied bars fastened over longitudinal cracks in the existing concrete.....	121
Figure C.16. Condition of 15th Street in September 2020.....	121

Tables

Chapter 2

Table 2.1. Example summary of pavement layer and thickness data for a composite pavement..... 8

Table 2.2. Suggested coring and material testing for evaluating existing pavement condition..... 13

Chapter 4

Table 4.1. Possible pre-overlay repairs on existing asphalt-surfaced pavements in preparation for an unbonded overlay..... 29

Table 4.2. Possible pre-overlay repairs on existing asphalt-surfaced pavements in preparation for a bonded overlay..... 32

Chapter 5

Table 5.1. Possible pre-overlay repairs on existing concrete pavements in preparation for an unbonded overlay..... 40

Appendix A

Table A.1. Summary of key design parameters.....84

Appendix B

Table B.1. Global experience with CRCP overlays.....100

Table B.2. US experience with CRCP overlays.....101

Table B.3. Performance data for CRCP overlays on asphalt-surfaced pavements in Oregon..... 102

Table B.4. Examples of unbonded CRCP overlays on concrete pavement in the US.....103

Table B.5. Performance data for unbonded CRCP overlays on concrete pavement in Illinois..... 105

Table B.6. CRCP and JPCP overlay designs developed in AASHTOWare Pavement ME Design.....109

Table B.7. CRCP overlay preservation schedule.....110

Table B.8. JPCP overlay preservation schedule.....110

Chapter 1

Introduction

Purpose and Scope	2
How to Use This Guide	2
Benefits and Historical Performance of Concrete Overlays	2
Asset Management through the Use of Concrete Overlays	3
Concrete Overlay Options	4
Construction and Quality Assurance of Concrete Overlays	5

Purpose and Scope

The *Guide to Concrete Overlays* presents basic principles needed by pavement engineers for the design and construction of concrete overlays on existing asphalt, composite, and concrete pavements. The intent is to increase the technical proficiency of experienced engineers while providing less experienced users with the basic knowledge to successfully address the needs of various types of concrete overlay projects. Additionally, this guide is intended to help users better recognize the versatility of concrete overlays, whether for application on low-volume roads, city streets, primary roadways, or Interstate highways.

The material in this guide takes users through important considerations in designing and constructing concrete overlays, starting with high-level scoping questions, such as the type and condition of the existing pavement, through detailed engineering considerations, such as treatment of the jointing system.

This is the fourth edition of the *Guide to Concrete Overlays*, with previous editions published in 2007, 2008, and 2014. This version has been updated with current information on continuously reinforced concrete pavement (CRCP) overlays, geotextile separation layers, fiber reinforcement, design procedures, and lessons learned from the experiences of numerous state highway agency (SHA) engineers.

How to Use This Guide

The *Guide to Concrete Overlays* incorporates numerous links to resource documents that provide additional information about many of the topics presented in this guide. Users are encouraged to consult these resources for detailed information on such topics as concrete overlay planning, construction, and repair.

In addition to this guide, the National Concrete Pavement Technology Center (CP Tech Center) has developed a set of resource materials—including webinars, tech briefs, and manuals and guides—to train and educate users on the applications and benefits of concrete overlay technology. Resources that especially complement the information in this guide include the following:

- *Guide for the Development of Concrete Overlay Construction Documents* (Gross and Harrington 2018)
- *Typical Overlay Construction Plans* (2018)
- *Guide Specifications for Concrete Overlays* (Fick and Harrington 2016)

These and other concrete overlay resources developed by the CP Tech Center and its partners are available for free download at <https://cptechcenter.org/concrete-overlays/>.

Benefits and Historical Performance of Concrete Overlays

Concrete overlays offer public agencies an economical, long-lasting solution for extending the life of an existing asphalt, composite, or concrete pavement and contribute meaningfully to an agency's overall asset management program. Relatively low-maintenance service lives of 20 years have been reported, with many overlays providing 30 to 40 years of service (McGhee 1994).

Concrete overlays are adaptable to a broad range of pavement conditions and project needs, and their excellent historical performance makes them an attractive option for addressing even the most challenging pavement preservation and rehabilitation circumstances, as shown in Figure 1.1.



Todd LaTorella, ACPA, MO/KS Chapter, used with permission

Figure 1.1. Unbonded concrete overlay with geotextile interlayer on Missouri Route D (top, in 2007 before overlay construction; bottom, in 2020 after 12 years of service)

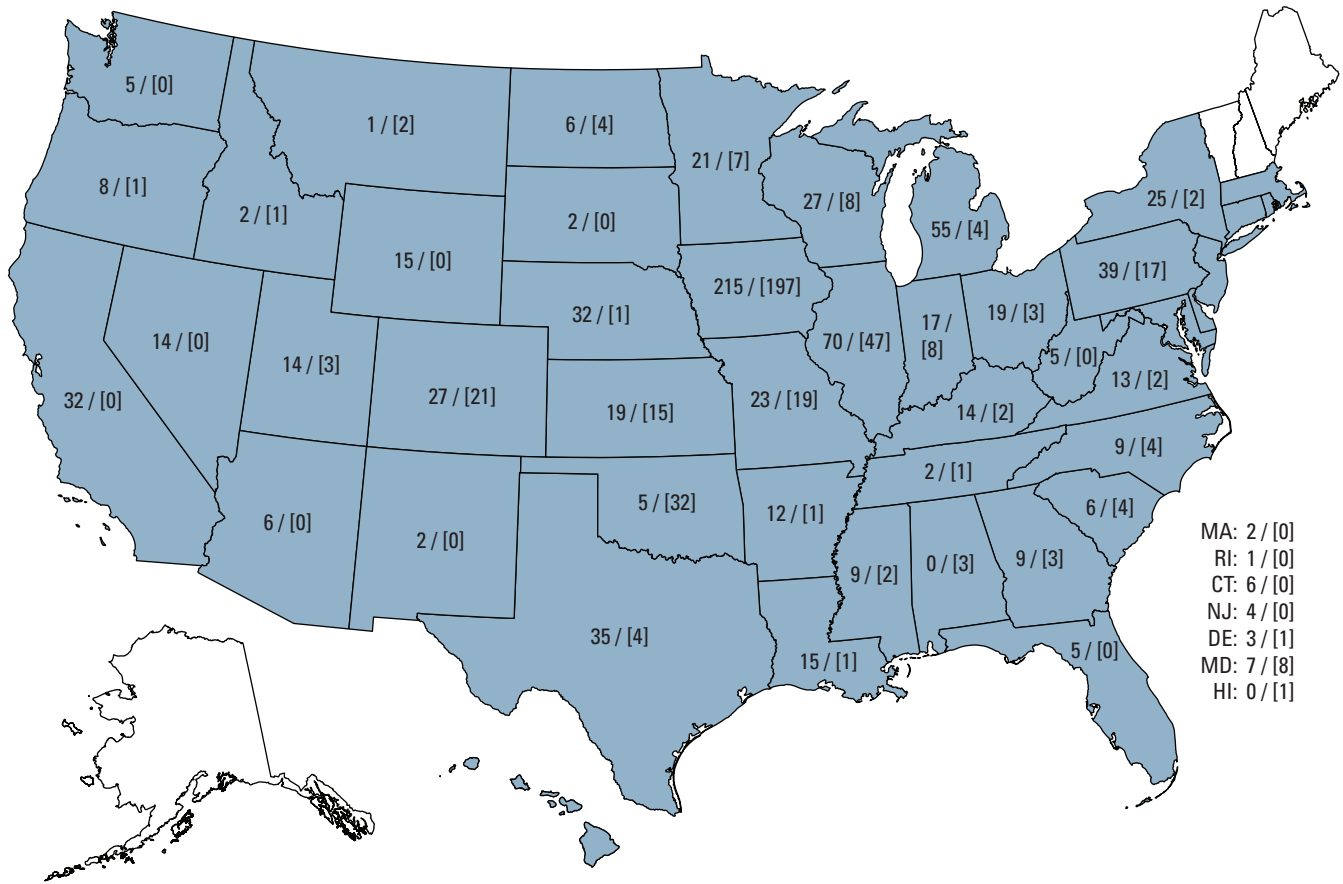

CP Tech Center

Figure 1.2. Concrete overlays in 46 states (overlays constructed 1901–1999/overlays constructed 2000–2017)

Portland cement concrete (PCC, referred to in this guide as simply “concrete”) has been used to resurface existing pavements since at least 1901, and by the mid-1980s concrete overlays were rapidly maturing into a standard rehabilitation option for many agencies. According to the American Concrete Pavement Association’s (ACPA’s) National Concrete Overlay Explorer (ACPA 2021), at least 46 states had built a collective total of 1,289 concrete overlays through 2017 (Figure 1.2).

Several resources document the history and excellent performance of concrete overlays:

- *History of Concrete Overlays in the United States* (Gross, forthcoming)
- *Concrete Overlay Performance on Iowa’s Roadways* (Gross et al. 2017)
- *National Cooperative Highway Research Program (NCHRP) Project 1-61: Evaluation of Bonded Concrete Overlays on Asphalt Pavements* (Pierce, forthcoming)
- *Performance of Concrete Overlays on Illinois Interstates, 1967 through 2016* (Heckel and Wienrank 2018)

Nevertheless, many agencies resort to either short-term repair techniques or premature reconstruction. The latter approach deprives agencies of the investment already made in the existing pavement, an investment that can be preserved by utilizing a concrete overlay.

Asset Management through the Use of Concrete Overlays

As an adaptable, economical, and long-lasting pavement resurfacing solution, concrete overlays can play a key role in an agency’s asset management program. Asset management involves a strategic and systematic approach to managing pavements that relies heavily on pavement management data and life-cycle cost analysis.

As part of an asset management program, a pavement preservation strategy at the network level is a long-term plan to enhance pavement performance by using an integrated, cost-effective set of practices that extend pavement life, improve safety, and meet motorist expectations without reconstruction. Pavement rehabilitation, an important option for pavement preservation, is defined as a structural or functional

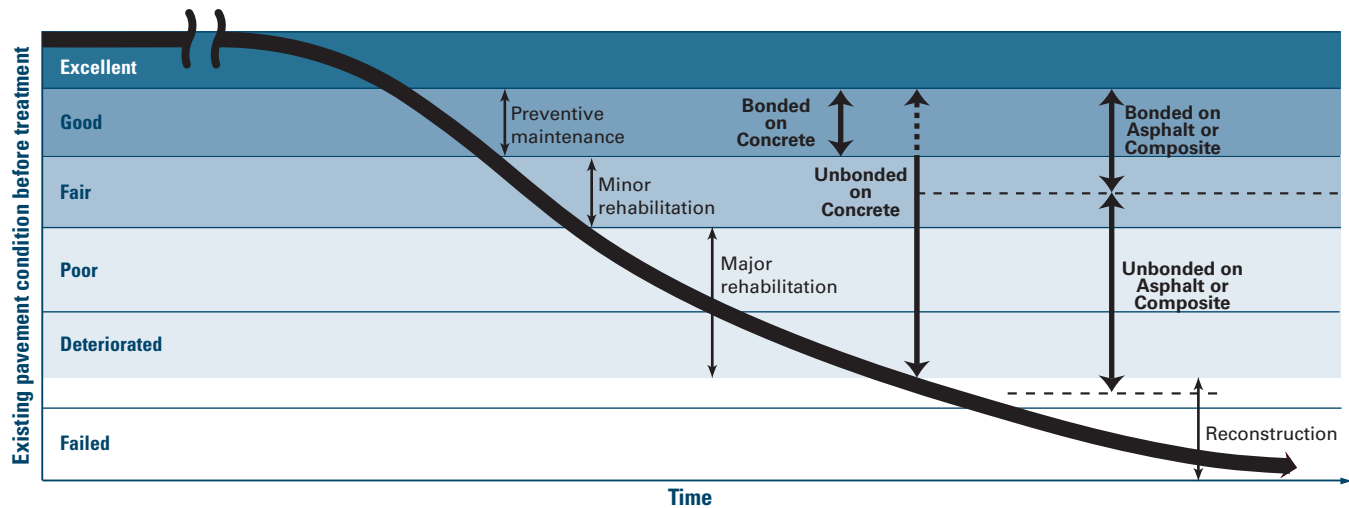

CP Tech Center

Figure 1.3. Typical bonded and unbonded concrete overlay solutions at various stages of pavement service life

enhancement of a pavement that produces a substantial extension in service life. As shown in Figure 1.3, concrete overlays can be used throughout the life of a pavement to address preservation and rehabilitation needs.

As an agency defines the objectives of its asset management strategy, an important decision is how to address the sustainability of its pavement choices while also making its pavements resilient to the extreme weather events that are becoming more common. Concrete overlays provide significant value for both sustainability and resilience.

The Federal Highway Administration (FHWA), through its Sustainable Pavement Program, has been actively working with SHAs and industry to provide practical guidance on how to make pavements more sustainable. Concrete overlays can be used very effectively to meet agency sustainability goals by preserving the equity investment in existing pavements and by providing long-life preservation or rehabilitation solutions. For more information on pavement sustainability, refer to the FHWA publication *Towards Sustainable Pavement Systems: A Reference Document* (Van Dam et al. 2015).

The resiliency of pavement systems is also critical for addressing the apparent trend towards more extreme weather-related events, especially infrastructure flooding. Concrete overlays can significantly contribute to resiliency by “hardening” pavement systems from storm damage and providing for the rapid restoration of traffic without compromising a pavement’s long-term performance. The Louisiana Transportation Research Center report *Impact of Hurricane Katrina on Roadways in the New Orleans Area* (Gaspard et al. 2007) concluded

that concrete pavement experienced little relative loss of strength due to being in a flooded condition when similar submerged and nonsubmerged concrete roadways were compared. Conversely, the report concluded that submerged asphalt pavement experienced a strength loss equal to 2 in. in thickness, resulting in the need for \$50 million to rehabilitate the over 200 mi of submerged asphalt pavements.

Concrete Overlay Options

Concrete overlays can be placed on existing asphalt, composite, jointed plain concrete pavement (JPCP), jointed reinforced concrete pavement (JRCP), and CRCP and can be used effectively on existing pavements in a variety of conditions. The specific details regarding the type of overlay (bonded or unbonded), thickness, joint pattern, load transfer devices (if any), and reinforcement (for fiber-reinforced concrete [FRC] and CRCP overlays) depend upon the following:

- Condition of the existing pavement
- Traffic loading
- Geometric constraints (such as curb and gutter sections, guardrails, shoulder widths, and vertical clearances)
- Desired design life

These decisions are straightforward, and this guide will assist the user in determining how to develop a concrete overlay solution to meet the needs of a specific project.

Concrete on Asphalt

Concrete on asphalt (COA) overlays can be designed to address a broad range of existing pavement conditions on both composite and full-depth asphalt pavements. Both bonded (COA-B) and unbonded (COA-U) options enable designs to cost-effectively match the condition of the existing asphalt—from deteriorated to good—as well as geometric parameters.

COA-B (Full Depth and Composite)

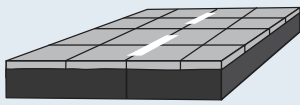

COA-U (Full Depth and Composite)

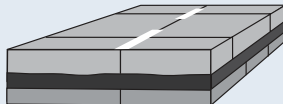
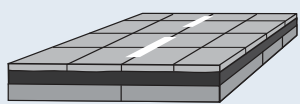
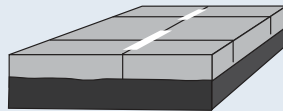

Concrete on Concrete

Concrete on concrete (COC) overlays can be designed for applications on both existing jointed plain concrete pavement (JPCP) and continuously reinforced concrete pavement (CRCP). The predominance of COC overlay designs are unbonded (COC-U) systems; however, bonded (COC-B) applications can be successful, provided the existing pavement is in good condition.

COC-B (JPCP and CRCP)

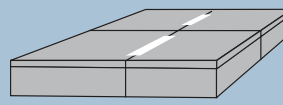

COC-U (JPCP and CRCP)

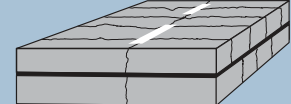
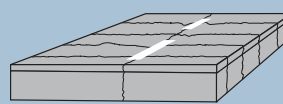
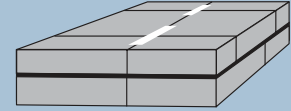

CP Tech Center

Figure 1.4. Four main types of concrete overlays

Based on the type of existing pavement being overlaid and whether the overlay is bonded or unbonded, concrete overlays are grouped into four main types:

- Concrete on asphalt–bonded (COA-B)
- Concrete on asphalt–unbonded (COA-U)
- Concrete on concrete–bonded (COC-B)
- Concrete on concrete–unbonded (COC-U)

Figure 1.4 illustrates the four overlay types.

Data from the ACPA's National Concrete Overlay Explorer (ACPA 2021) are useful for indicating the prevalence of the different types of overlay systems. Between 2000 and 2017, 29% of the concrete overlays constructed in the United States were concrete on concrete, including continuously reinforced pavements, and 71% were concrete on asphalt, including composite pavements.

All types of concrete overlays provide a simple, low-risk, versatile option for addressing most pavement conditions. In practice, however, the ACPA data show more frequent use of unbonded systems, which can be adapted to a wider range of existing pavement conditions. Bonded systems, though not used as frequently, are also in use by SHAs because they capitalize more directly upon the structural value in the existing concrete or asphalt pavement.

Construction and Quality Assurance of Concrete Overlays

Concrete overlays are constructed using the same materials, equipment, and processes as a concrete pavement placed upon a base course. It is important that best practices for material selection, mixture production, construction, and quality assurance are followed. The objective is to construct a durable, smooth concrete overlay that will meet or exceed the designed axle loadings over the life of the pavement. Information on concrete overlay construction is provided in [Chapter 8](#) of this guide.

Typical acceptance criteria for concrete overlays include thickness, strength, air content, combined gradation, and smoothness. Concrete mixture designs should utilize standard materials and normal testing procedures. Quality assurance for concrete overlays is outside the scope of this guide, but comprehensive guidance is available in the following resources:

- *Integrated Materials and Construction Practices (IMCP) for Concrete Pavements: A State-of-the-Practice Manual*, Chapter 9. Quality and Testing (Taylor et al. 2019)
- *Quality Control for Concrete Paving: A Tool for Agency and Industry* (Cavalline et al. 2021)
- *Field Reference Manual for Quality Concrete Pavements* (Fick et al. 2012)

Chapter 2

Evaluation of Existing Pavements and Selection of Concrete Overlay Options

Determining the Feasibility of a Concrete Overlay and Selecting the Appropriate Design	8
Step 1. Determine the Existing Pavement Type and Condition	8
Step 2. Make a Preliminary Determination of the Existing Typical Section Layers and Thicknesses	8
Step 3. Conduct an On-Site Review and Evaluation	11
Step 4. Determine the Need for Milling and Accommodating Adjustments of the Profile Grade	12
Step 5. Verify the Existing Pavement Condition: Coring and Material Testing	13
Step 6. Determine the Feasibility of a Concrete Overlay and the Appropriate Overlay Option	13
Next Steps	14

Successful overlay performance begins with selection of the appropriate overlay design for a given project. An evaluation of the existing pavement helps determine whether a concrete overlay is an appropriate option for preventative maintenance or rehabilitation and, if so, the appropriate overlay design. The evaluation of the existing pavement is a multistep process that must be approached carefully. Improper evaluation of the existing pavement condition can result in an overlay design that is inadequate for and/or incompatible with the needs of the situation, leading to poor overlay performance.

The evaluation also identifies distresses in the existing pavement to determine the appropriate overlay type for the conditions and the repairs needed before an overlay can be placed. In general, pre-overlay repairs should be limited to only those necessary to facilitate the appropriate overlay design, whether unbonded or bonded. Excessive pre-overlay repairs are costly and may indicate that the wrong type of overlay is being considered or the pavement is not a good candidate for an overlay.

This chapter provides a step-by-step process for evaluating the existing pavement and determining whether a concrete overlay is an appropriate rehabilitation option. The following steps should be followed in every case:

1. Determine the existing pavement type and condition
2. Make a preliminary determination of the existing typical section layers and thicknesses
3. Conduct an on-site review and evaluation
4. Determine the need for milling and accommodating adjustments of the profile grade
5. Verify the existing pavement condition: coring and material testing
6. Determine the feasibility of a concrete overlay and the appropriate overlay option

Determining the Feasibility of a Concrete Overlay and Selecting the Appropriate Design

Step 1. Determine the Existing Pavement Type and Condition

Review as-built plans and pavement management system records to determine the existing pavement type. Preliminary examinations can be performed virtually using digital data such as current images from a pavement management system or Google Earth.

This information can be used to assign a preliminary condition rating (Figure 2.1).

When selecting an appropriate concrete overlay design, assigning a pavement condition rating (good, fair, poor, or deteriorated) is a subjective process. Engineering judgment should be used because trigger values for frequency and/or severity of distresses do not exist. The illustrations and commentary in Figures 2.2 and 2.3 can be used as general guidance in assessing and assigning pavement condition ratings.

Step 2. Make a Preliminary Determination of the Existing Typical Section Layers and Thicknesses

Review historical documents to characterize the full pavement structure. This step can be performed concurrently with Step 1. From a review of as-built plans, maintenance records, and pavement management system data, at a minimum the following should be determined:

- Pavement layer types and thicknesses, by year of construction
- Base and subbase types and thicknesses
- Subgrade soil type

If readily available, mixture design information and construction quality control data should also be collected for future reference in the assessment process. An example of the information collected and summarized during this step is shown in Table 2.1.

Table 2.1. Example summary of pavement layer and thickness data for a composite pavement

Item	Comments
Asphalt surface	3 in. of Type X asphalt (2015) <ul style="list-style-type: none"> • 5.5% binder • 6.5% average in-place air voids
Concrete pavement	8 in. of JPCP (1971) <ul style="list-style-type: none"> • 15 ft joint spacing • 1¼ in. load transfer dowels
Subbase	6 in. of dense-graded crushed aggregate (1971)
Subgrade	A-4, compacted to 95% standard Proctor (1971)



Photos: Snyder & Associates, Inc., used with permission

Figure 2.1. Examples of determining existing pavement type and condition

Existing Concrete

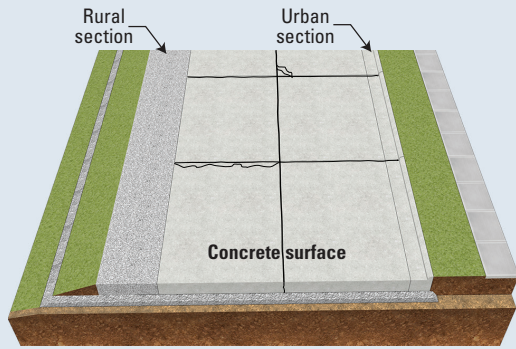

Good—Structurally sound with little to no cracking

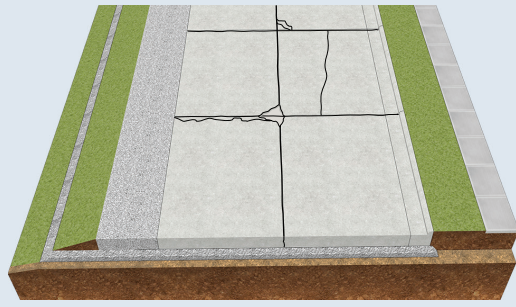

Fair—Structurally sound with minor surface distresses such as random cracking, periodic partial-depth joint spalling, and shadowing

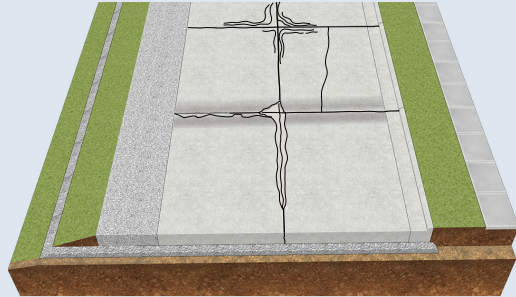

Poor—Full-depth joint deterioration, working cracks, spot structural failures, faulting, and/or material-related distress

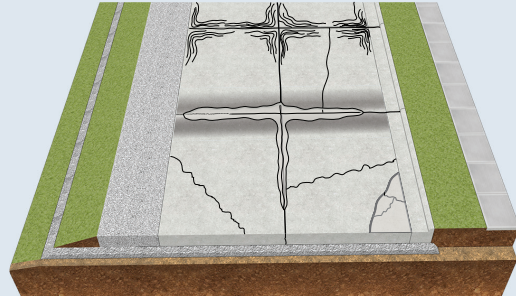

Deteriorated—Significant surface deterioration and structural distresses, including joint deterioration from freeze-thaw damage or material-related distress at 50% or more of the joints

Existing Asphalt

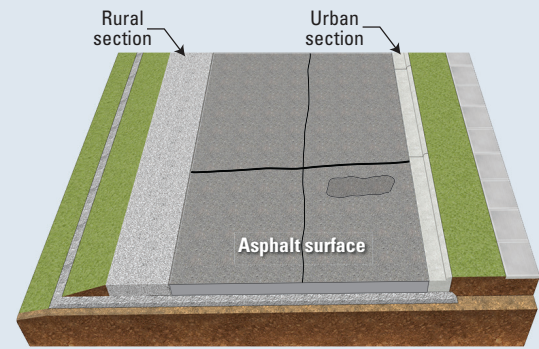

Good—Structurally sound with minor surface defects and minor cracking

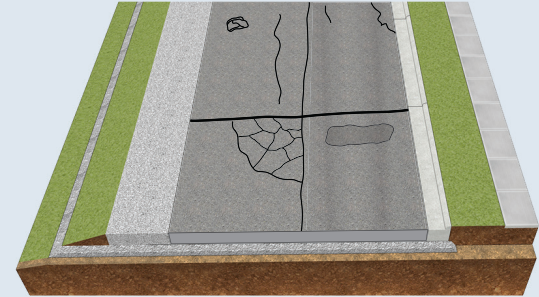

Fair—Structurally sound with minor surface distresses such as potholes, block cracking, or thermal cracking

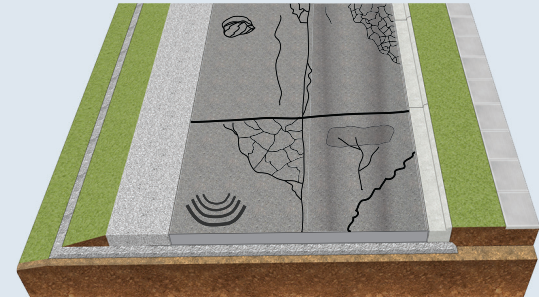

Poor—Frequent surface distresses such as potholes, block cracking, or thermal cracking plus alligator cracking, rutting, shoving, slippage, stripping, and raveling

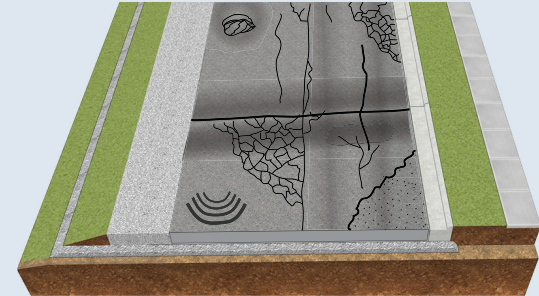

Deteriorated—Significant surface and structural distresses, including potholes, block cracking, or thermal cracking plus alligator cracking, rutting, shoving, slippage, stripping, and raveling

Illustrations: Snyder & Associates, Inc., used with permission

Figure 2.2. General guidance for rating the condition of concrete pavement

Illustrations: Snyder & Associates, Inc., used with permission

Figure 2.3. General guidance for rating the condition of asphalt and composite pavement

Step 3. Conduct an On-Site Review and Evaluation

After obtaining the historical project information, conduct an on-site inspection to further refine the project team's understanding of the pavement condition. The on-site visual survey is perhaps the most important step in evaluating the existing pavement condition.

Members of the design team should conduct the visual examination. It is advisable to also have the local maintenance engineer present to address questions about recent and persistent pavement maintenance issues that may influence the design of the overlay. At a minimum, the items described below should be reviewed and recorded for future reference.

Existing Pavement Distresses

For more details on evaluating distresses in existing concrete pavements, consult the *Guide for Concrete Pavement Distress Assessments and Solutions: Identification, Causes, Prevention, and Repair* (Harrington et al. 2018); for existing asphalt and composite pavements, consult the FHWA publication *Distress Identification Manual for the Long-Term Pavement Performance Program* (Miller and Bellinger 2014). These documents are useful for identifying pavement distresses and measuring their severity.

The evaluation of existing pavement distresses should involve the following:

- Identify all pavement distresses.
- Refine the pavement condition assessment initiated in Steps 1 and 2.
- Identify locations for pavement coring, which may be needed to further investigate the causes and extent of the pavement distresses.
- For concrete pavements and composite pavements, it is important to identify any materials-related distress (MRD). This may include alkali-silica reactions, D-cracking, and joint deterioration from various causes. The *Guide for Concrete Pavement Distress Assessments and Solutions: Identification, Causes, Prevention, and Repair* (Harrington et al. 2018) can be consulted to identify these distresses. In addition, note slab stability under truck loading and observe whether the slabs are stable or rocking.
- Estimate the extent of any needed pre-overlay repairs.

Drainage Conditions

The evaluation of drainage conditions should involve the following:

- Review the profile grade for extreme bumps and dips, which may indicate subgrade and/or drainage issues.
- Identify any moisture-related distresses and assess the condition of edge drains, if present.
- Note any drainage-related structural failures. A concrete overlay alone will not solve drainage issues. Rather, drainage issues are generally addressed through targeted drainage improvements, while drainage-related subgrade damage is mitigated by improving the pavement foundation.

Support Conditions

Note whether existing subgrade support conditions are reasonably uniform or there are isolated areas that may require pre-overlay repairs. Uniformity of support is interpreted as the presence of a continuous uniform support layer without major changes in stiffness that could be initiation points for reflective distresses. The following are common indicators of nonuniform support:

- Rocking panels and/or slabs that are cracked into three or more pieces
- Differing support conditions where the overlay spans the mainline-shoulder joint
- Areas of thin pavement after milling
- Existing pavements that have undergone extensive full-depth repairs

Vertical Constraints

Identify and quantify all vertical constraints, such as the following:

- Bridge structures
- Other overhead clearance requirements
- Guardrails, parapet walls, cable barriers, and median barriers
- Curb and gutter sections
- Storm sewer inlets
- Intersecting roadways and access drives
- Drainage conduits and culverts
- Safety slopes and ditches

Existing Shoulders and Widened Sections

Carefully document the support conditions and widths of existing shoulders and widened sections. For concrete overlays less than 8 in. thick, a change in support conditions between the mainline and the shoulders or widened sections requires specific design considerations for the longitudinal joints. [Chapter 3](#) and [Appendix A](#) summarize these considerations for various overlay types.

The characteristics of shoulders or widened sections can also impact maintenance of traffic during construction; they may need to be widened, resurfaced, and/or structurally upgraded to accommodate phased traffic strategies. See [Chapter 7](#) and [Appendix D](#) for more information on maintenance of traffic.

Additionally, note whether rumble strips are present. Depending upon the maintenance of traffic plans, these may need to be filled. Rumble strips will also need to be filled for an unbonded concrete overlay design using a geotextile separation layer to allow independent movement of the unbonded overlay.

Step 4. Determine the Need for Milling and Accommodating Adjustments of the Profile Grade

Up to this point, the evaluation process has been focused on gathering the information necessary to determine whether a concrete overlay is a viable design option. At this point in the evaluation process, it is necessary to calculate a preliminary estimate of the concrete overlay thickness required to carry the anticipated traffic over the overlay's design life. Information on developing a preliminary thickness estimate is provided in [Appendix A](#).

This estimate will also help determine any adjustments to the profile grade that may be required. In some cases, a concrete overlay will raise the profile grade, which has many potential geometric and cost impacts on existing roadway and roadside features such as bridges, overpasses, barrier rails, drainage structures, utilities, and so on. The estimated overlay thickness need not be exact; ± 2 in. is typically sufficient to gauge the impacts of raising the profile grade.

Milling

Milling the existing pavement is a way to mitigate the adjustment to the profile grade when constructing a concrete overlay. For existing asphalt-surfaced pavements, milling also accomplishes the following (see [Chapter 8](#)):

- Removes surface defects such as partial-depth top-down cracking, potholes, rutting, and shoving
- Controls the volume of concrete necessary for the concrete overlay
- Enhances the bonding potential for COA-B designs

Determining whether milling is necessary and to what depth is an iterative process. As the overlay thickness is refined from a preliminary estimate to a final design and as more information is known about the thickness and condition of the existing pavement layers, the estimated milling depth may need to be revised.

Roadway and Roadside Constraints on Vertical Change in Profile Grade

Vertical constraints arise from a variety of existing roadway and roadside features. The following are the most common vertical constraints and potential mitigation measures:

- Bridge structures require a transition from the overlay section to a full reconstruction section to match the existing profile grade.
- When overhead clearance requirements (overpasses, signs, utilities, and so on) are violated by a change in profile grade, a transition from the overlay section to a full reconstruction section or milling of the existing pavement to lower the profile grade is required.
- When possible, new safety slopes should be blended to the existing ditch line (Figure 2.4). If safety criteria cannot be met by blending the slopes, the ditch should be regraded and the safety slope flattened (Figure 2.5).
- For drainage conduits and structures, no mitigation is necessary if the safety slopes can be blended to the existing conditions (Figure 2.4). If the safety slopes are regraded, the drainage structures should be extended (Figure 2.5).
- Guardrails, parapet walls, cable barriers, and median barriers may need to be raised and/or reconstructed to accommodate a change in profile grade.
- When possible, the height of existing curb and gutter sections should be matched by milling the existing pavement to a depth equal to the overlay thickness. Otherwise, the existing curb and gutter section can be removed and replaced at the new profile grade or overlaid.

- When possible, the heights of existing storm sewer inlets and in-pavement utility structures should be matched by milling the existing pavement to a depth equal to the overlay thickness. Otherwise, the structures can be raised to match the new profile grade.
- Intersecting roadways and access drives can be reconstructed as needed, or the new surfacing can be tapered from the existing to the new overlay profile grade.

Chapter 7 provides more information on addressing profile transitions and curb and gutter sections.

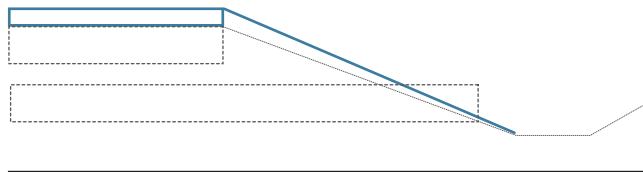

CP Tech Center

Figure 2.4. Blending safety slopes to existing conditions

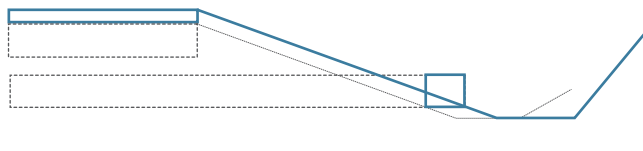

CP Tech Center

Figure 2.5. Regrading safety slopes and extending drainage structures

Step 5. Verify the Existing Pavement Condition: Coring and Material Testing

Compiling accurate and sufficient data regarding the existing pavement is the objective of every pavement evaluation. However, the recommended level of coring and material testing is dependent upon the functional classification of the roadway. A summary of the coring and material testing that may be conducted is provided in Table 2.2. Note that coring is not optional. Every project should be cored to verify the existing pavement thickness and condition and to identify whether any asphalt layers are prone to stripping.

Step 6. Determine the Feasibility of a Concrete Overlay and the Appropriate Overlay Option

This is the final step in determining whether a concrete overlay is an appropriate design strategy for an existing pavement and, if so, the appropriate overlay option. For clarity, the process is summarized in Figure 2.6 with a series of questions and possible overlay design outcomes by existing pavement type.

Table 2.2. Suggested coring and material testing for evaluating existing pavement condition

Investigation/Test	Low-volume rural or urban	Arterial or urban intersection	Secondary (state route)	Primary (US route/Interstate)
Coring (Pavement Layer Thicknesses)	Two cores per lane mile from the mainline and one core per lane mile from each shoulder	Two cores per lane mile from the mainline and one core per lane mile from each shoulder	Four cores per lane mile from the mainline and two cores per lane mile from each shoulder	Four cores per lane mile from the mainline and two cores per lane mile from each shoulder
Falling Weight Deflectometer (Support Values)	N/A	N/A	N/A	Yes
Ground Penetrating Radar (Layer Thicknesses)	N/A	N/A	Yes, if core thicknesses are variable	Yes
Coring and Petrographic Analysis	When MRD is suspected in the existing concrete, quantify potential for future expansion and/or deterioration			
Potential for Stripping (ASTM D4867)	As warranted from a visual examination of the cores			

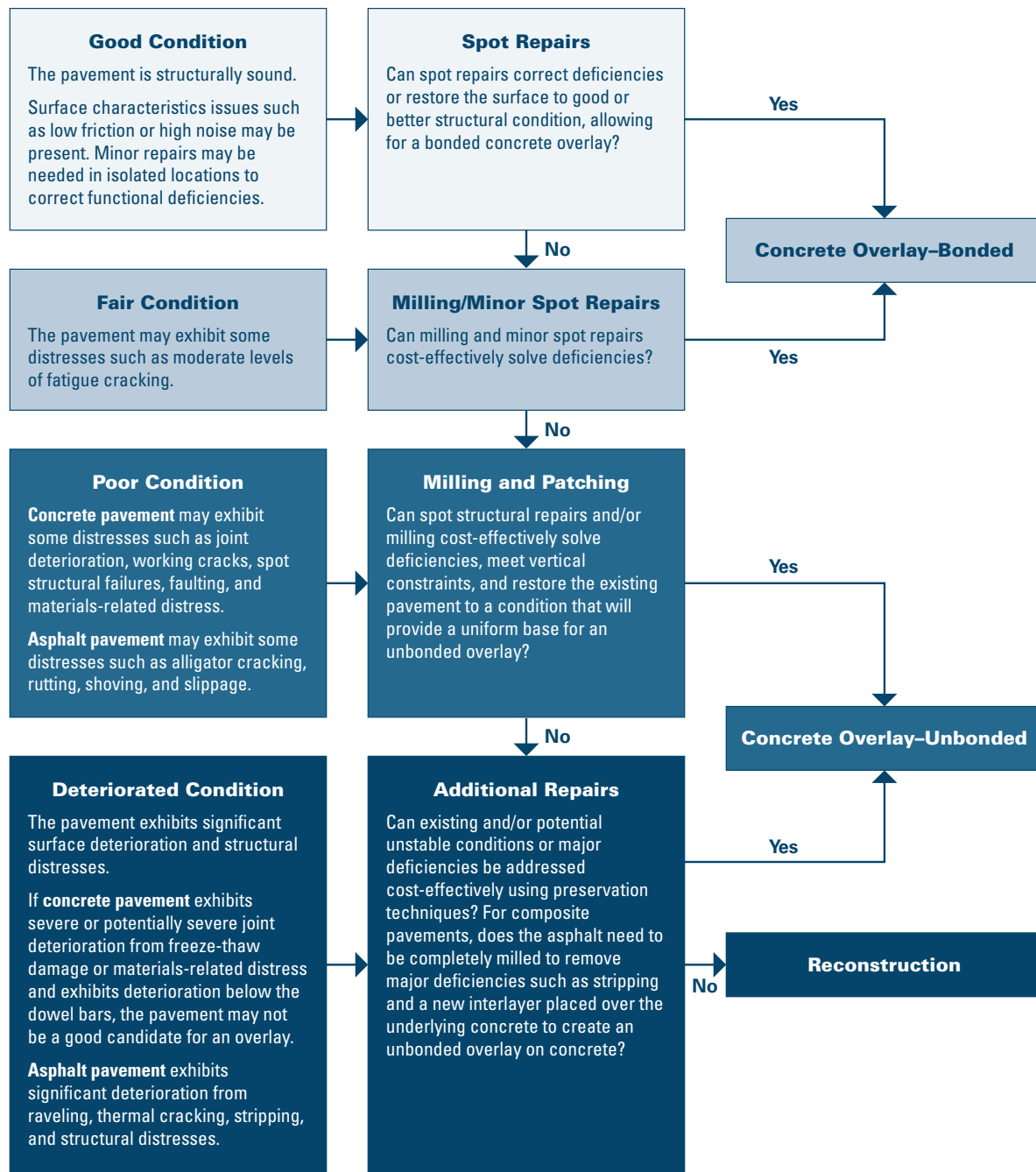

Figure 2.6. Determining the appropriate design strategy for a given project

Next Steps

Once a concrete overlay has been determined to be a practical solution for a given project, the remaining chapters of this guide summarize and recommend various design and construction options:

- [Chapter 3. Overview of Concrete Overlay Design](#)
- [Chapter 4. Concrete Overlays on Asphalt-Surfaced Pavements](#)

- [Chapter 5. Concrete Overlays on Concrete Pavements](#)
- [Chapter 6. Materials and Mixtures](#)
- [Chapter 7. Plan Development](#)
- [Chapter 8. Construction of Concrete Overlays](#)

Chapter 3

Overview of Concrete Overlay Design

Concrete Overlay Thickness Design	16
Typical Thickness Design Inputs and Considerations	16
Overview of Common Concrete Overlay Design Procedures	17
Key Design Considerations	17
Design Considerations for All Concrete Overlays	17
Design Considerations for Concrete on Concrete–Unbonded Overlays	18
Design Considerations for Concrete on Asphalt–Unbonded Overlays	19
Design Considerations for Concrete on Asphalt–Bonded Overlays	20
Design Considerations for Concrete on Concrete–Bonded Overlays	20
Additional Design Considerations to Address Impacts of Profile and Grade Changes	21
Overhead Clearance	21
Shoulder Considerations	21
Barriers and Rails	21
Foreslopes, Backslopes, and Across-Road Drainage Structures	21
Widening and Lane Additions	21
In-Place Structures	23
Curb and Gutter Details	23
Transitions	23

Concrete overlay design procedures generally consider user inputs such as anticipated traffic, climate, support layers, material properties, slab geometry, and performance criteria to develop a recommended overlay thickness. The designed overlay thickness is a major driver of overlay cost and is, therefore, a major factor in whether a concrete overlay is selected for a given project.

Moving beyond thickness design, however, the comprehensive design of concrete overlay systems includes many additional components:

- Determination of the type and extent of pre-overlay repairs
- Selection of construction materials with the appropriate properties
- Assumption of bonding or restraint at the interface between the overlay and the existing pavement (i.e., whether the overlay is bonded or unbonded)
- Design of edge support (e.g., for widened lanes or tied concrete shoulders), if any is needed
- Determination of overlay panel dimensions and joint layout
- Selection of joint design details (e.g., load transfer and sealant provisions), if special considerations are required

Some of these components, such as joint layout and construction material properties, can significantly impact concrete overlay performance. Other inputs, such as panel dimensions, joint details, edge support, and bond condition, directly impact overlay thickness and must be selected concurrently with, and as a part of, the thickness design. The goal of a successful concrete overlay design should be to address all overlay system design components in a manner that balances cost with desired performance in terms of quality and duration of service life.

Concrete Overlay Thickness Design

Designing a concrete overlay is a process that begins with characterizing the existing pavement (as outlined in [Chapter 2](#)), defining critical design variables, and then calculating the required overlay thickness. For more detailed information on thickness design, see [Appendix A](#).

Typical Thickness Design Inputs and Considerations

The following checklist includes many of the unique factors and design inputs that should be considered in overlay thickness design:

- Extent of pre-overlay repairs required
- Need for reflective crack control
- Overlay panel size
- Presence of reinforcement in the overlay slab
- Assumed bond or separation between the overlay and the existing pavement
- Separation layer characteristics (if a separation layer is used)

Several procedures are available for designing various types of concrete overlays. A major factor in selecting a thickness design procedure is the assumption of a bond (or lack thereof) at the interface between the overlay and the existing pavement.

The degree of bonding, mechanical interlock, or frictional resistance (hereafter simply referred to as “bond”) between a concrete overlay and the structural layer immediately below plays a major role in the behavior of and stress distribution through all layers in the overlaid pavement system.

When the overlay and existing pavement layers are bonded, they act together as a single layer with an effective thickness greater than that of either the overlay or the existing pavement and have a single neutral axis with respect to bending (Figure 3.1, left). When no bond exists between the overlay and existing pavement layers, the two layers bend separately, with each layer having its own neutral axis and each layer experiencing both tension and compression (Figure 3.1, right).

For design purposes, the overlay’s bond with (or separation from) the existing pavement is an assumed condition that must be selected carefully to avoid premature overlay distress. The structural impact of the overlay bond depends on the quality and integrity of both the overlay and the existing pavement, as well as the thickness of the existing pavement. A bonded overlay should not be selected unless the quality of the existing pavement (or the portion of that pavement that will remain) is of sufficiently high quality and adequate thickness.

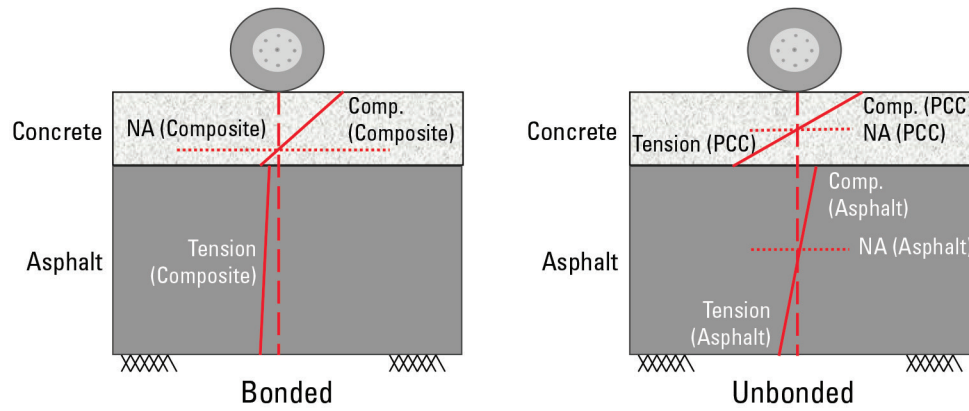

CP Tech Center

Figure 3.1. Behavior of and flexural stress distribution through the layers of bonded and unbonded overlay systems

Overview of Common Concrete Overlay Design Procedures

Four common procedures for designing concrete overlays (with their associated software applications) are listed below:

- AASHTOWare Pavement ME Design
- PavementDesigner.org
- University of Pittsburgh's BCOA-ME
- University of Pittsburgh's UNOL Design v1.0

Each procedure has its own design basis, strengths, and limitations. More detailed guidance on the selection and use of these procedures can be found in [Appendix A](#).

Key Design Considerations

Key design considerations for concrete overlays include general considerations for all types of overlays and considerations specific to the various overlay types.

Concrete overlay design parameters that vary by overlay type include typical expected service life, existing pavement condition requirements, slab thickness, panel dimensions, use of dowels and tie bars, and use of macrofibers. Table A.1 in [Appendix A](#) summarizes these parameters for various types of concrete overlays.

Refer to [Appendix A](#) for more detailed information on the design considerations presented in this section.

Design Considerations for All Concrete Overlays

Need for Uniform Support

For concrete overlays, as for concrete pavements in general, uniformity of support is far more important than strength of support. Thickness design can address the presence of a strong or weak foundation but cannot ensure good pavement performance if the foundation includes areas with abrupt changes in support or isolated large areas of stiffer or softer material.

Brand and Roesler (2014) and Roesler et al. (2016) describe procedures for analyzing concrete pavements under various nonuniform support conditions. Additional information on pre-overlay pavement evaluation is presented in [Chapter 2](#).

Use of Macrofibers

Macrofibers are frequently used in concrete overlays (especially for overlays 6 in. or less in thickness) to provide improved resistance to cracking, enhance the joint load transfer provided by aggregate interlock, restrain joint openings, and help retain slab fragments in place when cracks do develop. Additional information on the use of macrofibers in concrete overlays is presented in [Chapter 6](#).

Joint Activation

Joint activation (also called joint deployment) refers to the development of a crack (a working joint) below the sawcut made at a contraction joint. If a crack does not form beneath the sawcut, the joint has not activated or deployed, and the effective panel length is increased from the nominal panel dimension to the distance between the two nearest activated joints.

While construction practices can promote joint activation, activation mechanisms are also driven by certain pavement design parameters, including joint spacing, overlay thickness, and type of separation layer used (Gross et al. 2019).

Design Considerations for Concrete on Concrete–Unbonded Overlays

Pre-overlay Repairs

Existing concrete pavement provides very strong support to unbonded concrete overlays, and concrete overlays typically “bridge” over existing minor pavement defects such as cracks, spalls, faulting, and joint repairs without experiencing reduced service life. Therefore, it is not usually cost-effective to perform extensive pre-overlay repairs before placing COC–U overlays. However, designers should ensure that the existing pavement provides reasonably uniform support to the overlay layer, with no rocking panels or panel fragments and no large areas of significantly different structural composition, which can result from lane widening and large full-depth asphalt repairs.

Panel Dimensions and Joint Layout

The guidance provided in [FHWA Technical Advisory T 5040.30](#) (FHWA 2019) for conventional jointed concrete pavements is consistent with the successful common practices that have evolved for jointing COC–U overlays. Thinner COC–U overlays (6 in. thick or less) are typically constructed with nominal 6 ft square panels, while COC–U overlays with a thickness of 8 in. or more are typically constructed with full 12 ft lane widths and panel lengths ranging from 12 to 15 ft. COC–U overlays with intermediate thicknesses (between 6 and 8 in.) can be built conservatively with small panels but may be successfully built with full-lane-width panels in locations with a mild climate and/or low volumes of heavy traffic.

Transverse Joints: Dowel Bars, Macrofibers, and Sawcuts

Transverse joints for COC–U overlays can be either plain or doweled (or, in the case of continuously reinforced concrete overlays, nonexistent at locations other than construction headers). Undoweled joints are the most common transverse joint type for COC–U overlays with thicknesses of less than 7 in. because thinner overlays may not have sufficient truck traffic to warrant the use of dowels. The size and placement of dowels in COC–U overlays should be designed using conventional techniques. Macrofibers have also been shown to maintain acceptable load transfer in concrete overlays without dowels, especially in thin (6 in. thick or less), short-panel overlays.

The sawcut depth of transverse joints in COC–U overlays is typically $T/3$, but the depth may need to be greater (up to $T/2$) to prevent the development of dominant joints when COC–U overlays are constructed on geotextile fabric.

Longitudinal Joints: Location and Sawcuts

Longitudinal joints in COC–U overlays are generally located to match lane lines (which may or may not coincide with longitudinal joints in the underlying pavement). An exception may be for widened lanes, where panels are designed to extend some distance beyond the outside lane boundary into the shoulder to reduce load-related edge and corner stresses.

Additional longitudinal joints in COC–U overlays (located away from the lane lines) are often required for thinner overlays and overlays with smaller panels. Care should be taken to avoid placing these joints within wheel paths, where heavy traffic may cause rapid development of cracking and spalling at the interior corners, as shown in Figure 3.2 (King and Roesler 2014). For example, 4 ft wide panels have deteriorated more rapidly than 6 ft wide panels of the same thickness under heavy traffic because of longitudinal joint placement.

Longitudinal contraction joints are typically formed or cut to a depth of $T/3$. Care must be taken to ensure that any tie bars present are not cut or damaged during joint sawing.



Armen Amirkhania, used with permission

Figure 3.2. Concrete overlay on composite pavement photographed in 2012 after 13 years in service, with the overlay exhibiting interior corner deterioration due to longitudinal joints in the wheel paths

Joint Filling and Sealing

The primary use for joint filling and sealing is to prevent water and solids from getting into joints. Joint filling simply requires filling a sawcut with joint filler material after proper preparation. Experience has shown that joint filling is the recommended practice in areas where deicers and/or abrasives are applied to pavements. Joint sealing involves the use of a backer rod and more rigorous preparation of a sealant reservoir than joint filling. The use of an open-cell backer rod is not recommended in areas where deicing chemicals are used.

The ACPA (2018) provides recommendations that are valid for COC-U overlays concerning the need for (and potential benefits of) filling and/or sealing concrete pavement joints as a function of climate (whether deicers and/or abrasives are used), traffic, posted speed limit, and panel size.

Special Considerations for Continuously Reinforced Concrete Pavement Overlays

Unbonded CRCP overlays on concrete pavement have been (and continue to be) constructed in the US, with Texas and Illinois having the most experience with this overlay type. Details on the design and construction of CRCP overlays are provided in [Appendix B](#).

Thickness design for unbonded CRCP overlays should be performed using AASHTOWare Pavement ME Design. Asphalt separation layers are typically used to ensure reliable crack spacing development in the overlay. The only overlay joints that are required are transverse construction joints and longitudinal construction and contraction joints; sawcut depths and widths for longitudinal contraction joints in unbonded CRCP overlays are identical to those described previously for COC-U overlays. Sleeper slabs are preferred over lugs and wide-flange beams for terminal joints and transition slabs.

Design Considerations for Concrete on Asphalt–Unbonded Overlays

COA-U overlays include unbonded concrete overlays on both asphalt and composite pavements.

Existing asphalt and composite pavements are typically treated as composite foundations for COA-U overlays, and the overlay thickness is usually designed according to the method used for a new pavement on a very stiff foundation (which for COA-U overlays is the existing pavement structure).

COA-U overlays are typically designed without a separation layer because (1) there is usually no need to isolate the concrete overlay from the asphalt to prevent reflective distress and (2) a pure unbonded interface condition is a conservative design assumption but not a necessary construction condition for COA-U overlays. The same is not true for COC-U overlays, for which a separation layer is typically required to prevent reflective distress.

Pre-overlay Repairs

COA-U overlays, whether placed on asphalt or composite pavement, rarely require extensive pre-overlay repair because (1) the overlay usually bridges intact areas of raveling, fatigue cracking, and similar types of existing asphalt or composite pavement distress and (2) the overlay thickness design is unlikely to change as a result of the repairs. It is only necessary that the existing pavement provide reasonably uniform support to the overlay layer, with no rocking panels or panel fragments and no large areas of significantly different structural composition. The existing pavement should be free of wide joints and cracks, unrepaired potholes, and other features that would permit the overlay to interlock or “key” with the pavement.

Even when no pre-overlay repairs are required, it may be desirable to mill the pavement surface to eliminate deep ruts or unstable asphalt layers or to reduce profile grade changes that lower overpass clearances or create other safety and geometric problems, such as the need to raise guardrails or adjust ditch slopes.

Panel Dimensions, Joint Layout and Design, and Joint Sealing

The guidance concerning panel dimensions, joint layout and design, and joint sealing for COA–U overlays is essentially identical to the guidance provided previously for COC–U overlays. However, the presence of asphalt surface rutting or the need for changes in pavement cross section (e.g., to increase cross slope, make grade corrections, or change superelevation) can introduce additional design and specification considerations.

Special Considerations for Continuously Reinforced Concrete Pavement Overlays

Several unbonded CRCP overlays on asphalt-surfaced pavement were constructed in the US in the 1960s and 1970s, and performance has been reported to be satisfactory. Few additional unbonded CRCP overlays on asphalt-surfaced pavement have been built in the US in recent decades, except for some thin and ultra-thin CRCP overlays on flexible pavements in transition areas in Texas (Chen et al. 2016). Additional details concerning the design and construction of these overlays are presented in [Appendix B](#).

Design Considerations for Concrete on Asphalt–Bonded Overlays

COA–B overlays include bonded concrete overlays on both asphalt and composite pavements.

General Design Considerations

A COA–B overlay should only be considered for an existing asphalt-surfaced pavement that is in (or can cost-effectively be restored to) good structural condition. COA–B overlays are typically thinner than COA–U overlays because of the increased structural capacity afforded by bonding the concrete and asphalt layers.

The development and maintenance of an adequate bond between the concrete overlay and the existing asphalt pavement is critical to the performance of a COA–B overlay. Loss of the bond (or failure to develop an adequate bond) will accelerate the development of pavement distress and reduce the overlay's service life, especially for thinner overlays. Existing design procedures for COA–B overlays do not specifically address the

required strength of the overlay bond but rather treat it primarily as a construction issue because bond-related failures rarely occur when proper construction and curing techniques are used. Refer to [Chapter 8](#) for information on construction and curing practices.

The following items should be used to guide decisions concerning the design and specification of COA–B overlays:

- Foundation support conditions
- Required pre-overlay repairs
- Overlay materials
- Maximum overlay thickness
- Panel dimensions and joint layout and design
- Use of dowel bars, tie bars, and macrofibers
- Risk of reflective cracking
- Joint filling and sealing needs
- Achievement and maintenance of the pavement-overlay bond

Special Considerations for Continuously Reinforced Concrete Pavement Overlays

The only evidence of bonded CRCP overlays on asphalt-surfaced pavement in the US is presented by Chen et al. (2016), who describe some thin and ultra-thin CRCP overlays on flexible pavements in transition areas in Texas.

Design Considerations for Concrete on Concrete–Bonded Overlays

General Design Considerations

Thin bonded concrete overlays are rarely constructed on existing concrete pavements for the following reasons:

- Successful construction of a COC–B overlay requires that the existing pavement be in good to excellent condition, and such pavements are rarely programmed for rehabilitation or preservation unless major increases in traffic volume or load (beyond the original design levels) are anticipated.
- A good bond between the overlay and the existing pavement can be achieved but requires heightened attention to construction practices, concrete overlay materials, and weather during construction.
- If the bond is lost, even locally at slab corners, cracking is almost certain to develop quickly. Remediation may require expensive, time-consuming full-depth repairs.

The development and maintenance of an adequate bond between the overlay and the existing pavement is critical to the performance of COC–B overlays, especially for thin overlays that provide little structure of their own for carrying service loads.

Properly designed and constructed COC–B overlays can reasonably be expected to provide a minimum service life of 15 years before maintenance is required. See [Appendix C](#) for further details on the design and construction of this type of overlay.

Special Considerations for Continuously Reinforced Concrete Pavement Overlays

Even less common than jointed COC–B overlays, bonded CRCP overlays on concrete pavement are usually economically viable only when very little pre-overlay repair is required. Most recent examples of this overlay type were constructed in Texas in the 1980s and have yielded acceptable performance. Additional information on the design and construction of CRCP overlays is provided in [Appendix B](#).

Thickness design for bonded CRCP overlays on concrete pavement should be performed using AASHTOWare Pavement ME Design. The only joints that are required in this overlay type are transverse construction joints, matched repair joints, and longitudinal construction and contraction joints; sawcut depths and widths should match those used for conventional COC–B overlays.

Additional Design Considerations to Address Impacts of Profile and Grade Changes

Changes to the pavement profile, cross section (e.g., due to lane widening), and cross slope (e.g., due to improvements to surface drainage and superelevation) that result from an overlay of any type can trigger certain overlay design modifications and roadway design changes.

Refer to [Appendix A](#) for more detailed information on the design considerations presented in this section.

Overhead Clearance

The presence of overhead structures, power lines, and other features, combined with regulations for minimum overhead clearance, may need to be addressed in the overlay design.

Shoulder Considerations

Lane widening and lane additions often result in the placement of concrete overlays on at least a portion of the existing shoulder, which may provide a different level of support than the travel lanes that underlie most of the overlay, especially if the shoulder is unpaved. This difference in support must be properly addressed in design and construction to avoid longitudinal cracking in the overlay over the existing pavement's lane-shoulder joint.

Barriers and Rails

Safety barriers, guardrails, and cable barriers may need to be adjusted or reconstructed, depending on the change in profile grade and the horizontal distance between the edge of the pavement and the safety feature.

Foreslopes, Backslopes, and Across-Road Drainage Structures

Overlaying an existing pavement with either asphalt or concrete typically results in changes in the elevation of the pavement edge, unless the existing pavement is milled to allow placement of an inlay that maintains the existing pavement's profile and cross section.

Designers should address pavement profile changes in ways that minimize the impacts to ditch lines, ditch slopes, drainage structures, and available right-of-way. Such impacts can be minimized (or eliminated) by implementing the following design options as appropriate: (1) inlay all or a portion of the new surface layer, (2) maximize the pavement's cross slope within allowable limits, and/or (3) maximize the cross slopes of the pavement and unpaved shoulder within allowable limits.

Widening and Lane Additions

Concrete overlay projects provide opportunities for widening pavements. Properly designed and constructed widening sections reduce pavement edge stresses, corner stresses, and deflections, thus reducing panel cracking and joint faulting (i.e., the difference in elevation between the opposing sides of a joint or crack [Miller and Bellinger 2014]) while improving ride quality and safety.

Widening a travel surface using a concrete overlay requires an evaluation of any changes in foundation support, appropriate use of reinforcing steel, and proper longitudinal joint placement. This is especially true for widening overlays placed over existing concrete pavements with unbound shoulder materials because of the increased risk of longitudinal cracking along the edge of the existing pavement. (Figure 3.3).

Some general recommendations for pavement widening using concrete overlays include the following:

- Keep longitudinal joints out of wheel paths whenever possible, especially for COA–B overlays.
- For unbonded overlays of asphalt or concrete pavement, match the longitudinal joints of the overlay with the longitudinal edge joints of the existing pavement and add tied widening units when possible unless this results in joints within wheel paths of the overlay.
- When the overlay is placed wider than the existing pavement, avoid locating the edge joints of the overlay more than 12 to 18 in. beyond the existing pavement’s lane edges unless the existing shoulder has a structure that provides support similar to that of the existing pavement lane. If this cannot be done, follow the guidance of the previous bullet.
- Tie widening units to either the overlay or to the existing pavement using deformed bars (see the [widening detail](#) in the example construction drawings published by the CP Tech Center).
 - For concrete overlays 5 in. thick or more, locate the tie bars in the overlay at mid-depth. Refer to the discussion on pavement widening details in [Chapter 7](#).
 - For concrete overlays less than 5 in. thick, secure the tie bars to the surface of the existing pavement, taking care not to allow traffic to loosen the secured tie bars.

Not every detail will apply to every project, but the recommendations listed above can often be applied to address project-specific issues.

Adding new lanes or shoulders can also present issues unique to concrete overlay pavement design, especially if there is variation in the underlying support of the overlay or if the overlay is to abut a full-depth concrete pavement. Joint load transfer systems are frequently used in such cases when the overlay system is unbonded. Longitudinal joint tie bars are used to ensure that edge support is provided by aggregate interlock. The design should address the possibility of differential settlement and water infiltration at these locations.



Armen Amirkhaniyan, used with permission (top); Matt Zeller, Concrete Paving Association of Minnesota, used with permission (center and bottom)

Figure 3.3. Concrete overlay widening on Illinois Route 53 with no longitudinal joint or reinforcing over existing pavement edge (top); concrete overlay widening on Minnesota TH 212 with longitudinal joints and reinforcing over existing pavement edge in some locations (center) and only reinforcing in other locations (bottom)

To prevent cracking related to differential expansion and contraction between a concrete overlay and a full-depth concrete lane addition, use an isolation joint (i.e., a butt joint with no tie bars) if the overlay is less than 5 in. thick.

In-Place Structures

Existing intakes and utility structures must be raised to match the new pavement elevation. Typical details for adjusting manholes are shown in an [example construction detail](#) published by the CP Tech Center.

Curb and Gutter Details

Existing curb and gutter sections may pose overlay design challenges related to the maintenance of surface drainage, overlay profile elevation, and so on. Design options and strategies for curb and gutter sections are presented in [Chapter 7](#).

Transitions

Concrete overlay designs usually require details concerning the transition sections linking the concrete overlay with adjacent pavement sections, adjacent structures, and driveway entrances/exits. Transition sections often feature isolated or otherwise unsupported transverse end joints and have the potential to experience impact loading as vehicles cross the end joint. These conditions result in higher stresses in many transition areas, necessitating the use of thicker concrete sections and conventional deformed slab reinforcement, wire mesh reinforcement, and/or macrofibers. Transition lengths are usually based on the design speed for the section. Additional details and examples regarding transition sections are provided in [Chapter 7](#).

Chapter 4

Concrete Overlays on Asphalt-Surfaced Pavements

Concrete on Asphalt–Unbonded Overlays	26
Application and Uses	27
Performance	27
Keys to Success	27
Maintenance and Repairs	29
Concrete on Asphalt–Bonded Overlays	29
Application and Uses	30
Performance	30
Keys to Success	30
Maintenance and Repairs	33

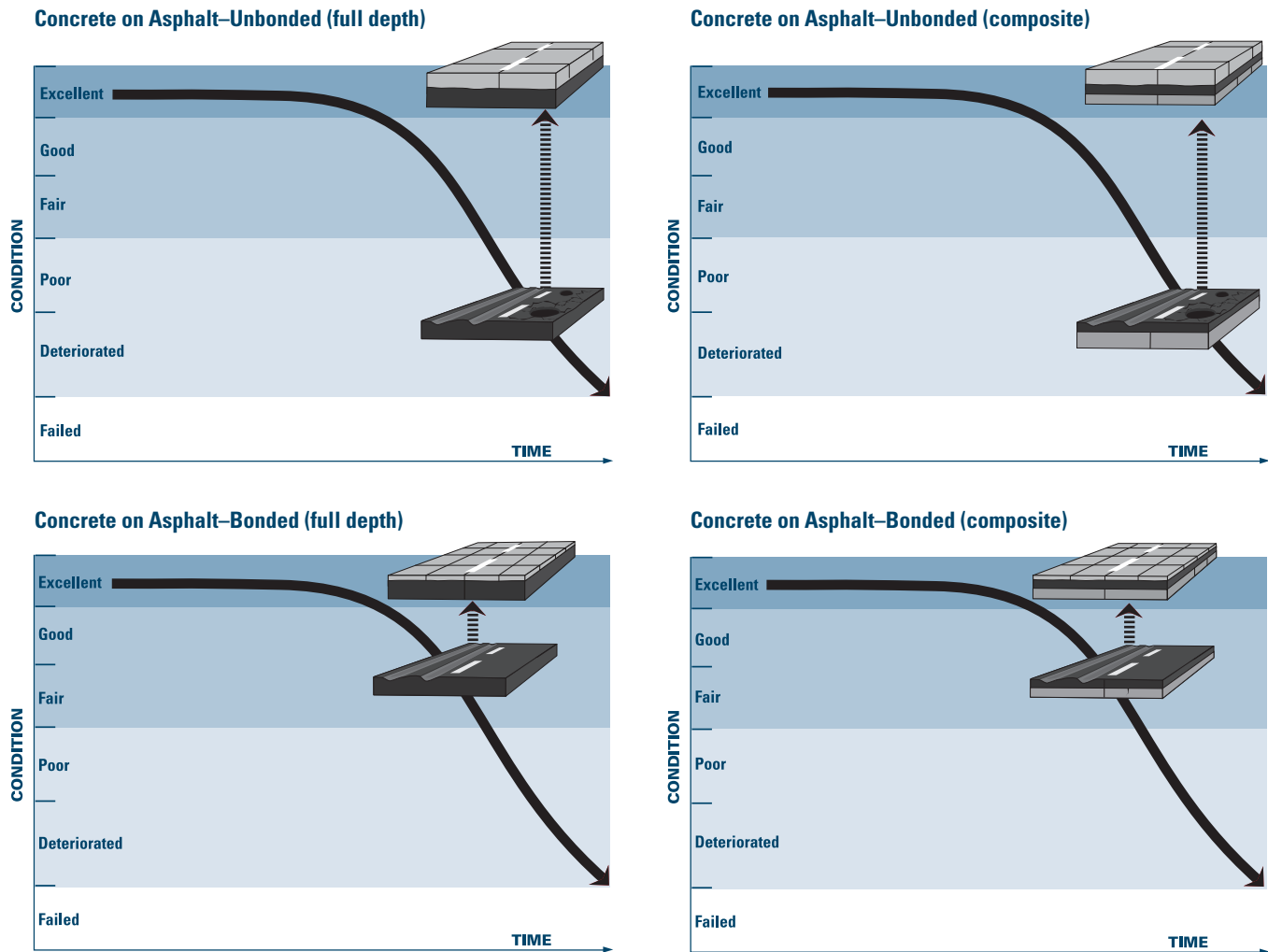

CP Tech Center

Figure 4.1. Bonded and unbonded overlays of existing asphalt and composite pavements

Concrete overlays on existing asphalt-surfaced pavements encompass JPCP or CRCP overlays on both asphalt pavements and composite pavements (concrete that has been previously resurfaced with asphalt). These overlays can be either bonded or unbonded. (See [Appendix A](#) for a summary of the overlay options on asphalt-surfaced pavements.) Asphalt-surfaced pavements with significant structural deterioration, inadequate base/subbase support, or stripping of asphalt layers due to inadequate drainage are not good candidates for a bonded overlay; in such cases, an unbonded overlay should be considered (Figure 4.1).

Concrete on Asphalt–Unbonded Overlays

Figure 4.2 shows a schematic view of two COA–U overlays, one on an existing asphalt pavement and one on an existing composite pavement.

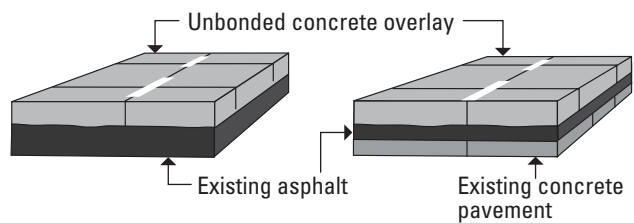

CP Tech Center

Figure 4.2. COA–U overlays on existing asphalt (left) and composite (right) pavements

Application and Uses

COA-U overlays generally have the following characteristics and uses:

- Can be appropriate for asphalt and composite pavements with significant hot-mix asphalt (HMA) deterioration, such as severe rutting, potholes, alligator cracking, subgrade/subbase issues, shoving, and pumping
- Can be applied to composite pavements with slow-reacting MRD and/or significant cracking
- Are designed as a concrete layer on top of the existing pavement layer(s), assuming an unbonded condition between the new and existing layers, and are typically not designed to include a separation layer
- Are generally 6 in. thick or more for JPCP overlays or 7 in. thick or more for CRCP overlays
- Add structural capacity to the roadway
- Eliminate surface defects such as asphalt rutting, shoving, and potholes
- Do not require extensive pre-overlay repairs but may require spot repairs of certain areas to minimize localized failures
- Do not rely on bonding, though some partial bonding between the overlay and existing asphalt pavement may occur and can improve the performance of the pavement

See [Chapter 2](#) for information about identifying distresses in existing pavements, and see [Appendix A](#) for information on unbonded overlay design.

Performance

Unbonded overlays of asphalt-surfaced pavements have been used successfully in many states, with more than 30 years of good to excellent performance (as illustrated in Figures 4.3 and 4.4). To learn more about the performance history of COA-U overlays, refer to the following case histories in the tech summary *History of Concrete Overlays in the United States* (Gross, forthcoming):

- Case History #3–CR-56 in LaSalle County, Illinois
- Case History #4–US-287 in Kiowa County, Colorado
- Case History #7–I-69 in Grant County, Indiana
- Case History #8–I-35 in Love County, Oklahoma



Angela James Folkestad, ACPA, CO/WY Chapter, used with permission

Figure 4.3. Unbonded on asphalt



Brent Burwell, ACPA, OK/AR Chapter, used with permission

Figure 4.4. Unbonded on composite

Keys to Success

Pavement Evaluation

An evaluation of the existing pavement, described in [Chapter 2](#), is necessary to ensure that it is a good candidate for an unbonded overlay. Some of the key conclusions from the pavement evaluation should include the following:

- Structural condition and estimated support values
- Whether milling is required and, if so, to what depth(s)
- For composite pavements specifically, presence of MRD, early stages of buckling due to degradation and movement at the joints in the underlying concrete pavement, and slabs that move or rock under traffic loading
- Quantification of needed pre-overlay repairs

Asphalt pavements are good candidates for unbonded overlays if the existing asphalt layer(s) can provide, or can be cost-effectively repaired to provide, a stable platform for the overlay. See [Appendix A](#) for information on unbonded overlay design.

Consideration should be given to the condition of both layers (for composite pavements), variability in the existing profile grade (possible evidence of active panel movement), and the composite k value of all existing pavement layers.

Overlay Design

Important design elements for COA–U overlays include the use of the existing pavement as a base, overlay thickness, mixture design, joints, and drainage. Refer to [Appendix A](#) for additional information on the design details noted in this section and [Chapter 2](#) for information on evaluating the condition of the existing pavement.

Use of the Existing Pavement as a Base. In an unbonded overlay design, the existing multilayered pavement is treated as a support system that can be characterized as a single layer of composite material. The structural design assumes an unbonded condition between the new overlay and the existing asphalt surface, and COA–U overlays are typically not designed to include a separation layer. The existing asphalt should be evaluated for its ability to provide a stable subbase for the unbonded overlay and resist future stripping.

Regardless of whether the asphalt will be milled or remain in its existing condition, the minimum thickness of remaining asphalt to be overlaid must be adequate to provide a stable working platform capable of withstanding all anticipated construction traffic (specifically, trucks loaded with concrete); this is typically at least 3 to 4 in. of sound asphalt.

For a composite pavement, if the existing asphalt is determined to be unsuitable as a base for an unbonded overlay, it can be milled off to expose the underlying concrete pavement and can be treated as an unbonded overlay of existing concrete utilizing a new separation layer. Refer to [Chapter 5](#) for information on COC–U overlays.

Overlay Thickness. Unbonded overlay thicknesses typically range from 6 to 12 in. The required overlay thickness is affected by the overlay's desired load-carrying capacity and service life, as well as the condition of the underlying pavement. Portions of a project with significantly different existing pavement and subbase conditions may be broken into separate sections that are designed to specifically address those conditions.

Mixture Design. Conventional concrete mixtures are typically used for unbonded overlays of asphalt-surfaced

pavements. When accelerated opening to traffic is desired, conventional concrete mixtures should be proportioned for rapid strength gain without increased shrinkage. For unbonded overlays less than 6 in. thick, high-modulus structural fibers are often used to improve the fracture toughness and post-cracking behavior of the concrete. Refer to [Chapter 8](#) for information on opening overlays to traffic and [Chapter 6](#) for information on the use of fibers in concrete overlays.

Joint Design. Load transfer design for concrete overlays is the same as that used for new concrete pavements. Doweled joints are used for unbonded overlays of pavements that will experience significant truck traffic (such overlays are typically 7 in. or more in thickness).

Drainage. During the evaluation and design stages of an unbonded concrete overlay project, the existing subgrade drainage should be evaluated. Stripping of the existing asphalt can lead to secondary consolidation of the stripped layer, resulting in cracking of the unbonded overlay due to nonuniform support. Steps should be taken to ensure adequate drainage (e.g., retrofitting edge drains and using free-draining shoulder materials and geotextiles). When underdrains are present, they should be inspected with video cameras, cleaned, and repaired as necessary.

Construction

Important construction elements for COA–U overlays include use of direct placement, pre-overlay repairs, milling, patch preparation, surface cleaning, concrete placement, curing, and joint sawing. Refer to [Chapter 8](#) for additional information on the construction and maintenance activities noted in this section and [Chapter 2](#) for information on evaluating the condition of the existing pavement.

Use of Direct Placement. Direct placement without milling is a viable option when rutting in the existing asphalt pavement does not exceed 2 in. and there is no significant surface deterioration or stripping of the asphalt layers. Any existing pavement ruts are filled with concrete, resulting in a thicker overlay above the ruts.

Pre-overlay Repairs. Unbonded overlays generally require minimal pre-overlay repairs of the existing pavement. If significantly distressed areas are not shifting or moving and the subgrade/subbase is stable, costly repairs typically are not needed (see Table 4.1).

Table 4.1. Possible pre-overlay repairs on existing asphalt-surfaced pavements in preparation for an unbonded overlay

Existing pavement condition	Possible repairs to consider
Area of subgrade/subbase failure	Remove and replace with stable material (i.e., select borrow, granular subbase, etc.); correct water problems
Severe distress that results in variation in strength of asphalt	Remove and replace with asphalt material or concrete patch with slurry seal or geotextile separation layer; correct water problems
Reflective faulting or panel tenting	Full-depth repair with concrete and use asphalt or geotextile separation layer as bond breaker
Potholes	Fill with asphalt
Shoving	Mill
Rutting ≥ 2 in.	Mill
Rutting < 2 in.	None or mill
Crack width \geq maximum coarse aggregate size used in the overlay mixture	Fill with suitable crack fill material or cementitious grout to prevent overlay “keying” or interlock

Milling. If surface distortions in the existing pavement are 2 in. or greater, milling is recommended prior to placing an unbonded overlay. Milling can (1) eliminate high spots to help ensure a minimum overlay depth, (2) provide a more uniform overlay thickness to minimize quantity overruns, and (3) remove damaged asphalt material that is not suitable in a support layer.

Surface Cleaning. Before concrete placement, the surface to be overlaid should be thoroughly swept to achieve uniform contact and friction between the concrete overlay and the existing asphalt surface.

Concrete Placement. Best practice is to pave on a damp surface. When the asphalt pavement surface is at or above 120°F (49°C), wetting can also reduce the surface temperature and lower the risk of early-age cracking. The pavement surface should be free of standing water at the time of overlay placement.

Conventional concrete paving practices and procedures for placing, spreading, consolidating, and finishing the concrete overlay are followed. Because of variations in the surface of the existing pavement, the concrete material should be bid on a volume (cubic yard) basis. Some states also include a bid item for placement, measured on a square yard basis. See [Chapter 7](#) for additional information on estimating and bidding quantities.

Curing. Good curing practices are essential for overlays, especially for thin unbonded overlays because of their high surface area-to-volume ratio. Good curing is accomplished by applying a high-quality curing compound (as described in [Chapter 6](#)) at the specified rate immediately after surface texturing and prior to

the occurrence of significant surface evaporation. (For detailed information on curing, see *Curing Concrete* [Taylor 2013].) The cured surface and vertical faces of the overlay should be free from streaks and appear uniformly white like a sheet of paper.

Joint Sawing. Timely joint sawing is necessary to prevent random cracking. Transverse and longitudinal sawcut operations should be performed before any uncontrolled cracking occurs.

Maintenance and Repairs

The recommended repair options for unbonded overlays are the same as those for standard concrete pavements.

Concrete on Asphalt–Bonded Overlays

Figure 4.5 shows a schematic view of two COA–B overlays, one on an existing asphalt pavement and one on an existing composite pavement.

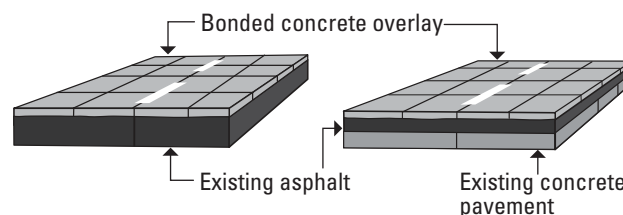

CP Tech Center

Figure 4.5. COA–B overlays on existing asphalt (left) and composite (right) pavements

Application and Uses

COA–B overlays generally have the following characteristics and uses:

- Can be applied to asphalt or composite roads, streets, and intersections in fair or better structural condition with typical distresses such as rutting, shoving, minor alligator cracking, and thermal cracking
- Are typically 6 in. thick or less
- Rely on the existing asphalt-surfaced pavement to provide additional load-carrying capacity, with the design assuming a bond between the overlay and the existing asphalt surface to form a monolithic structural section, thereby reducing stresses and deflections (See [Appendix A](#) for information on bonded overlay design.)
- Add structural capacity where traffic loads have increased or are anticipated to increase
- Eliminate surface defects such as rutting and shoving

Performance

Bonded concrete overlays of asphalt-surfaced pavements have been used successfully in many states to maintain and rehabilitate asphalt pavements with surface defects (as illustrated in Figures 4.6 and 4.7). Numerous studies (such as *NCHRP Project 1-61: Evaluation of Bonded Concrete Overlays on Asphalt Pavements* [Pierce, forthcoming] and *Concrete Overlay Performance on Iowa's Low Volume Roadways* [Gross et al. 2017]) have shown bonded concrete overlays to deliver a durable surface course, provided that (1) a sufficient bond exists between the asphalt surface and concrete overlay (see Appendix A for information on developing an overlay bond), (2) the existing asphalt pavement provides adequate structural support, and (3) panel sizes are selected to reduce slab stresses and minimize early-age debonding.

To learn more about the performance history of COA–B overlays, refer to the following case histories in the tech summary *History of Concrete Overlays in the United States* (Gross, forthcoming):

- Case History #1–US-69 in Pittsburg County, Oklahoma
- Case History #2–SR-16 in Dawson County, Montana
- Case History #5–US-89 in Provo, Utah
- Case History #6–SH-13 north of Manchester, Iowa



Angela James Folkestad, ACPA, CO/WY Chapter, used with permission

Figure 4.6. Bonded on asphalt



Dan King, Iowa Concrete Paving Association, used with permission

Figure 4.7. Bonded on composite

Keys to Success

Pavement Evaluation

An evaluation of the existing pavement, described in [Chapter 2](#), is necessary to determine whether a bonded overlay is appropriate for a given project. Some of the key conclusions from the pavement evaluation should include the following:

- Existing structural condition and estimated support values
- Whether milling is required and, if so, to what depth(s)
- Whether a minimum of 3 in. of sound asphalt remains after any milling
- Quantification of pre-overlay repairs

Asphalt pavements with significant structural distresses, inadequate base/subbase support, or stripping of the asphalt layers are not good candidates for a bonded concrete overlay; in such cases, an unbonded overlay should be considered.

Composite pavements are not good candidates for a bonded overlay if they display any of the following:

- Significant structural deterioration, inadequate or uneven subgrade/subbase support, poor drainage conditions, or stripping or delamination of the asphalt layers
- Problems in the underlying concrete due to MRD
- Indications of possible future durability problems

Overlay Design

Important design elements for COA–B overlays include overlay thickness, mixture design, joint design, and drainage. Refer to [Appendix A](#) for additional information on the design details noted in this section and [Chapter 2](#) for information on evaluating the condition of the existing pavement.

Overlay Thickness. The design thickness for COA–B overlays is generally 4 to 6 in., depending on the desired load-carrying capacity and service life of the overlay and the structural capacity provided by the underlying pavement. Additional overlay thickness may be required in transition sections to prevent movement of the overlay panels adjacent to the existing asphalt pavement and to reduce the potential for cracking due to traffic impact loadings.

Mixture Design. Conventional concrete mixtures have been successfully used for COA–B overlays. For bonded overlays less than 5 in. thick, high-modulus structural fibers are often used to improve the fracture toughness and post-cracking behavior of the concrete. (See [Chapter 6](#) for information on the use of fibers in concrete overlays.) These benefits apply to overlays greater than 5 in. thick as well. Early opening times can be identified by the use of maturity measurements. For information on maturity testing, see [Chapter 9 of the IMCP manual](#) (Taylor et al. 2019).

Joint Design. The recommended joint pattern for COA–B overlays results in small, approximately square panels, typically in the range of 3 to 8 ft, with a preferred slab size of approximately 6 ft. Shorter joint spacing helps maintain a low bond stress between the concrete overlay and the asphalt and reduces load and curling stresses in the slab. The use of tie bars for bonded overlays should follow the guidance summarized in [Appendix A](#). Macrofibers can substitute for tie bars in many sawn contraction joints, but tie bars are needed for construction joints.

Filling the joints in bonded overlays has been proven to improve performance in wet-freeze climates. For information on joint filling and sealing, see the ACPA tech brief [Concrete Pavement Joint Sealing/Filling](#) (ACPA 2018). For information on the performance of sealed overlay joints, see [Impact of Sealed Joints on Performance of Thin Whitetopping at MnROAD](#) (Burnham 2012).

Drainage. Stripping or delamination in the underlying asphalt layer can lead to premature failure of the bonded concrete overlay. During the evaluation and design stages of a bonded concrete overlay project, the existing surface and subsurface drainage should be evaluated in a manner similar to that used for an asphalt resurfacing design. When underdrains are present, they should be cleaned, video inspected, and repaired as necessary.

Construction

Important construction elements for COA–B overlays include use of direct placement, pre-overlay repairs, milling, surface cleaning, concrete placement, curing, joint sawing, and joint sealing. Refer to [Chapter 8](#) for additional information on the construction and maintenance activities noted in this section and [Chapter 2](#) for information on evaluating the condition of the existing pavement.

Use of Direct Placement. Direct placement without milling is a viable option when rutting in the existing asphalt pavement does not exceed 2 in. and there is no significant surface deterioration or stripped layers in the asphalt. Any ruts in the existing pavement are filled with concrete, resulting in a thicker overlay above the ruts.

Pre-overlay Repairs. Recommended pre-overlay repairs when placing bonded concrete overlays on existing asphalt and composite pavements are summarized in [Table 4.2](#).

For existing composite pavements, vertical movement of the underlying concrete should be mitigated with full-depth repairs. For all existing asphalt-surfaced pavements, if cracking in the existing pavement is of medium to low severity, it can be controlled without repairing the underlying pavement by adding macrofibers to the overlay mixture or, in some cases, by placing reinforcing steel over the joint/crack in the existing pavement (see [Figure 4.8](#)). For information on the latter method, refer to the [example construction detail](#) published by the CP Tech Center.

Table 4.2. Possible pre-overlay repairs on existing asphalt-surfaced pavements in preparation for a bonded overlay

Existing pavement distress	Spot repairs to consider
Rutting ≥ 2 in.	Mill
Rutting < 2 in.	None or mill
Shoving, slippage	Mill
Crack width \geq maximum coarse aggregate size used in the concrete overlay mixture	Fill with suitable crack fill material or cementitious grout to prevent overlay “keying” or interlock.
Crack width $<$ maximum coarse aggregate size used in the concrete overlay mixture	None
Low- to medium-severity potholes	Remove loose material and fill integrally with the concrete overlay.
High-severity potholes and/or areas needing full-depth repair	To prevent a single overlay panel from bonding to both asphalt and concrete, make full-depth repairs across a full lane width with concrete and adjust the transverse joint spacing in the concrete overlay to match the location of the underlying patch. The full lane width prevents trying to match a longitudinal joint to a partial lane patch.



James Cable

Figure 4.8. Placement of reinforcing steel over a crack in an existing asphalt-surfaced pavement

Milling. Typically, milling asphalt surfaces to improve bonding between the overlay and the existing pavement is not required; however, consideration should be given to milling asphalt surfaces that have little texture. The main objectives of milling prior to placing a bonded overlay are (1) to minimize raising the profile grade of the roadway, (2) to remove significant surface distortions containing deteriorated asphaltic material that may result in an inadequate bonding surface, (3) to reduce high spots to help ensure a minimum overlay depth and reduce the quantity of concrete needed to fill low spots, and (4) to match the elevations of curbs or adjacent structures.

The minimum thickness of structurally sound asphalt required for bonding is 3 in. (Refer to [Appendix A](#) for information on determining the appropriate thickness of the existing asphalt.) This applies to both existing composite and asphalt pavements.

Construction traffic—particularly trucks loaded with concrete—can cause significant damage to the existing

asphalt pavement. Measures should be taken to ensure that the construction process does not damage the asphalt pavement being overlaid.

Surface Cleaning. Following pre-overlay repairs, the asphalt surface should be cleaned to enhance bonding between the existing asphalt surface and the new concrete overlay.

Concrete Placement. Best practice is to pave on a damp surface. When the asphalt pavement surface is at or above 120°F (49°C), wetting can reduce the surface temperature and lower the risk of early-age cracking. The pavement surface should be free of standing water at the time of overlay placement.

Conventional concrete paving practices and procedures for placing, spreading, consolidating, and finishing the concrete overlay are followed. Because of variations in the surface of the existing pavement, the concrete material should be bid on a volume (cubic yard) basis. Some states also include a bid item for placement, measured on a square yard basis. See [Chapter 7](#) for information on estimating and bidding quantities.

Curing. Good curing practices are essential for overlays. Good curing is accomplished by applying a high-quality curing compound (as described in [Chapter 6](#)) at the specified rate immediately after surface texturing and before surface evaporation becomes significant. The cured surface and vertical faces of the overlay should be free from streaks and appear uniformly white like a sheet of paper.

Joint Sawing. Transverse and longitudinal sawcut operations should be performed in a timely manner before any uncontrolled cracking occurs. Joint sawing should commence as soon as the concrete has developed sufficient strength for joints to be cut without significant raveling. Lightweight early-entry saws may be used to allow the sawing crew to get onto the pavement as soon as possible. With a typical joint spacing of 3 to 6 ft, extra saws will likely be needed to avoid unplanned cracks. The depth of the sawcut joints should follow the recommendations provided in [Appendix A](#).

Joint Sealing. In wet-freeze climates, contraction and construction joints should be filled with a hot-poured joint sealant (the use of a backer rod is not recommended). (See [Appendix A](#) for information on joint sealing options and procedures.) In other climates, joints may remain unfilled if the risk of infilling with incompressibles is low.

Maintenance and Repairs

Joints in COA–B overlays should be maintained to prevent the ingress of moisture and incompressibles. See [Appendix A](#) for information on the benefits of joint sealing.

COA–B overlays may be repaired using full-panel replacement (as described in [Chapter 8](#)) or by milling and inlaying with concrete. Defects should not be patched with asphalt because adjacent concrete panels will move and break the bond between the overlay and the asphalt patch. If a panel is cracked but pavement ride quality is not compromised, the panel should be left in place. If a ride quality problem develops, the panel should be replaced before any pieces of concrete come loose from the overlay.

Chapter 5

Concrete Overlays on Concrete Pavements

Concrete on Concrete–Unbonded Overlays	36
Application and Uses	36
Performance	37
Keys to Success	37
Maintenance and Repairs	41
Concrete on Concrete–Bonded Overlays	41

When a concrete pavement structure approaches the end of its intended service life or experiences an unacceptable level of deterioration, rarely does reconstruction result in an economical solution. Concrete overlays that are 2 to 4 in. thick or that are 6 in. thick or more are sound preservation and rehabilitation strategies, respectively, for existing concrete pavements. With the placement of an overlay, the existing pavement is restored from deficient conditions and gains service life (Figure 5.1). Concrete overlays on existing concrete pavements include both JPCP and CRCP overlays.

Concrete on Concrete–Unbonded Overlays

COC–U overlays can be found on all functional classifications of roadways. By definition, COC–U overlays consist of a new portland cement concrete surface placed over an existing concrete pavement.

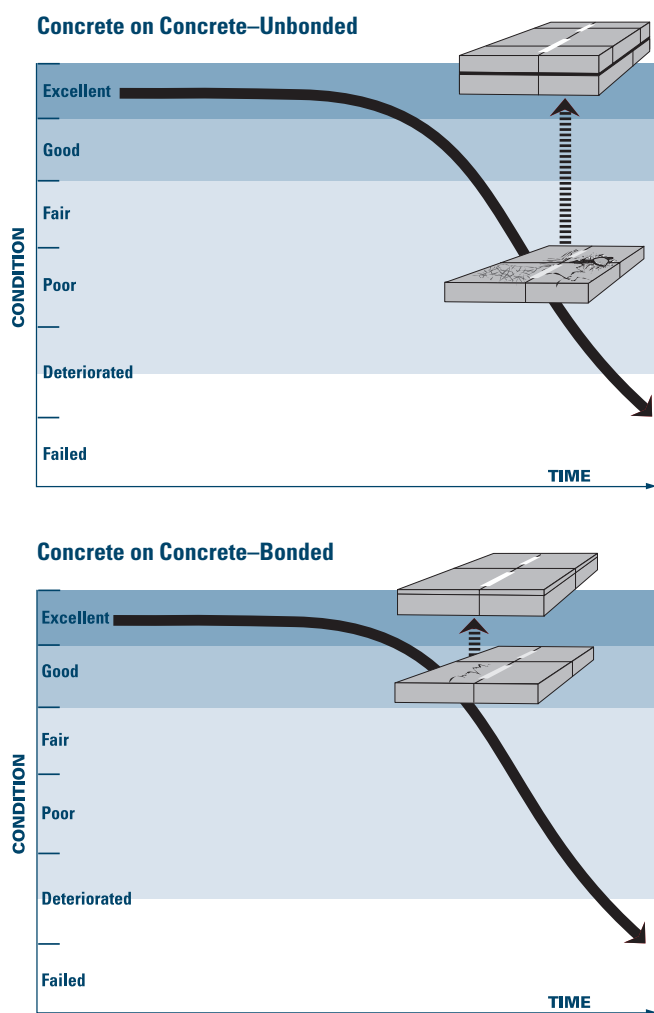

CP Tech Center

Figure 5.1. Bonded and unbonded overlays of existing concrete pavements

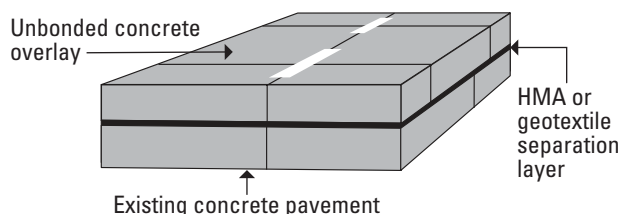

CP Tech Center

Figure 5.2. COC–U overlay

The two concrete layers are separated by an asphalt or geotextile separation layer designed to provide isolation, bedding, and/or drainage. Figure 5.2 shows a schematic view of an unbonded overlay over concrete pavement.

COC–U overlays are a cost-effective pavement rehabilitation technique typically placed on existing concrete pavements in poor or deteriorated condition. Even pavements experiencing MRD can still provide stable and uniform support for a successful COC–U overlay rehabilitation. COC–U overlays allow an agency to maximize its return on investment by realizing as much life as possible from the initial pavement asset. Unbonded concrete overlays over concrete pavements have been successfully used throughout the US for over 40 years.

Application and Uses

COC–U overlays generally have the following characteristics and uses:

- Are designed essentially as a new concrete pavement on a stable base course
- Restore or enhance the pavement’s structural capacity
- Improve surface friction, noise, smoothness
- Have a pavement life comparable to that of a new full-depth pavement
- Do not experience reflective cracking due to the use of an asphalt or geotextile separation layer, assuming uniform support conditions provided by the existing pavement

Performance

COC-U overlays offer excellent potential for successful long-term performance, even when the underlying pavement is in relatively poor condition. A 2008 project on Route D within the Kansas City, Missouri, metropolitan area illustrates this potential. In 2007, Route D was a 22-year-old, 8 in. thick JPCP that had substantial D-cracking in the transverse and longitudinal joints (Figure 5.3, top). The unsound material in the deteriorated joints was removed, and the joints were cleaned and filled with 2,000 psi cementitious repair material without reestablishing (sawing over) the existing (transverse) joints.

The existing pavement was overlaid with 5 in. of plain (i.e., without steel or fibers) unbonded concrete with a geotextile fabric serving as the separation layer (Figure 5.3, bottom). The single-cut joints sawed in the 6 ft by 6 ft panels were left unsealed. The 5 in. thick unbonded concrete overlay solution eliminated the need for conducting costly full-depth repairs and resulted in a more long-lasting resurfacing. Route D has continued to provide excellent service for over 12 years and is still operational today.



Todd La Torella, ACPA, MO/KS Chapter, used with permission

Figure 5.3. Route D existing concrete in deteriorated condition in 2007 (top); 5 in. unbonded overlay constructed on Route D in 2008 (bottom, photo taken in 2020)

Critical factors that affect the performance of unbonded overlays include uniform support from the existing pavement, the type of separation layer used, overlay thickness, joint spacing layout, load transfer design, and the type of cementitious joint repair material used.

To learn more about the performance history of COC-U overlays, refer to the following case histories in the tech summary *History of Concrete Overlays in the United States* (Gross, forthcoming):

- Case History #11-US-131 in Allegan County, Michigan
- Case History #12-I-85 in Granville County, North Carolina
- Case History #17-I-40 in North Little Rock, Arkansas

Keys to Success

The following actions will help ensure a successful project:

- Design the overlay as essentially a new concrete pavement on a stable base layer (the existing concrete pavement).
- Consider full-depth repairs only where structural integrity needs to be restored to provide uniform support or to eliminate rocking or moving slabs.
- An asphalt separation layer with a minimum thickness of 1 in. or a geotextile fabric separation layer is required to isolate the overlay from the existing concrete and prevent reflective cracking.
- Provide a stripping-resistant, dense-graded asphalt layer or a drainable asphalt separation layer to prevent separation layer stripping. For a geotextile fabric separation layer, daylight the fabric to the foreslope or to a drainage conduit.
- During the evaluation of the existing concrete pavement, consider joint milling/grinding if a geotextile fabric separation layer will be used and faulting exceeds $\frac{1}{4}$ in. or if an asphalt separation layer will be used and faulting exceeds $\frac{3}{8}$ in.
- Determine whether the existing concrete pavement provides uniform and continuous support.
- Sawcut joints in thinner unbonded overlays as soon as possible, because the sawing window may be shorter than it typically is for full-depth slabs. Thinner unbonded overlays have a typically shorter sawing window because the surface area-to-volume ratio is larger than that of conventional full-depth concrete pavements, resulting in more rapid cooling and drying contraction.

- Shorter joint spacing in an unbonded overlay compared to a full-depth pavement will reduce curling and warping stresses.
- Matching the transverse joints in the existing pavement is not necessary for unbonded overlays except for the existing pavement's expansion or isolation joints. For unbonded overlays, the expansion and isolation joints in the existing pavement should be reproduced in the overlay, with the overlay's joint locations matched to those of the underlying pavement.

Pavement Evaluation

One of the first steps in determining whether a pavement is a good candidate for a COC-U overlay is to evaluate the condition of the existing pavement and its performance issues and their causes, as described in [Chapter 2](#). This information also indicates the extent of the spot repairs required before an overlay can be constructed. Typically, minimal repairs are needed for unbonded concrete overlays, making them a cost-effective solution. Two key characteristics of the existing pavement should be noted during the pavement evaluation: uniformity of support and presence of faulting.

Uniformity of Support. For an unbonded overlay, it is necessary to determine whether the existing concrete pavement and its subbase can provide reasonably uniform support and whether any corrective actions are needed. The evaluation of support conditions also determines the existing pavement's structural contribution as a stable support layer without significant differential movement, drainage issues, erosion, or subgrade stability issues. Differential movement across the transverse joints of the existing concrete pavement must be evaluated to determine that it will not result in differential movement of the concrete overlay and lead to overlay cracking.

Presence of Faulting. Pavement faulting can usually be attributed to a combination of reduced load transfer between slabs and reduced subgrade/subbase support. When the subgrade/subbase is stable, the increase in load-carrying capacity provided by an unbonded overlay has proven to be adequate to prevent joint faulting. The maximum faulting depth is recommended to be no more than $\frac{3}{8}$ in. when a 1 in. thick asphalt separation layer is used and no more than $\frac{1}{4}$ in. when a geotextile separation layer is used. The recommended limits are intended to prevent keying of faulted joints through the separation layer and into the concrete overlay. When these depths are exceeded, corrective measures such as surface grinding or, in the case of an asphalt separation layer, increasing the separation layer thickness are necessary.

Overlay Design

Unbonded overlays are designed similarly to new concrete pavements, in that the thickness and stiffness of the support layers is considered and a separated condition (unbonded slip) between the overlay and the existing pavement is assumed. Critical design factors that control overlay performance are use of the existing pavement as a base, overlay thickness, use of FRC, use of a separation layer, separation layer material, concrete mixture design, joint design, joint activation, and drainage. Refer to [Appendix A](#) for additional information on the design details noted in this section.

Use of the Existing Pavement as a Base. In an unbonded overlay design, the existing multilayered pavement is treated as a support system that can be characterized as a single layer of composite material. The structural design assumes an unbonded condition between the new overlay and existing concrete surface. The existing concrete should be evaluated for its ability to provide a stable subbase for the unbonded overlay and to resist future deterioration.

Regardless of whether the concrete pavement will be milled or remain in its existing condition, the minimum thickness of concrete to be overlaid must be adequate to provide a stable working platform capable of withstanding all anticipated construction traffic (specifically, trucks loaded with concrete). This is typically a minimum of 4 in. of concrete.

Overlay Thickness. The required overlay thickness is affected by the desired load-carrying capacity and service life of the overlay, as well as by the condition of the existing concrete pavement.

Use of Fiber-Reinforced Concrete. FRC technology for concrete pavements was introduced several decades ago, and in the last 15 years the use of synthetic macrofiber reinforcement in concrete overlays has increased. A [study of concrete overlays in Illinois](#) reported that FRC overlays performed better than similar plain concrete overlays (Heckel and Wienrank 2018). The known benefits of FRC for concrete overlays include increasing load-carrying capacity, decreasing crack widths, maintaining load transfer efficiency across joints or cracks, and extending pavement service life through reduced crack deterioration. Macrofibers have replaced tie bars across contraction joints in thinner overlays (4 to 5 in. thick) with short panel sizes, though not across construction joints. Because FRC has been shown to decrease crack deterioration and thus improve long-term durability at a reasonable cost, it is recommended that

4 to 6 in. thick unbonded overlays use FRC. For more information about FRC in concrete overlays, see *Fiber-Reinforced Concrete for Pavement Overlays: Technical Overview* (Roesler et al. 2019).

Use of a Separation Layer. In unbonded overlays, a separation layer is placed between the existing pavement and the overlay to help eliminate reflective cracking and is one of the primary factors influencing the performance of COC–U overlays. The separation layer provides a shear plane that helps prevent existing pavement cracks from reflecting into the new overlay.

Separation Layer Material. The use of nonwoven geotextile as a separation layer has increased substantially over the last 10 years. The other commonly used separation layer is a 1 in. drainable HMA, which provides adequate coverage over irregularities in the existing pavement. In an effort to reduce asphalt consolidation and pore pressure in HMA separation layers, typical asphalt mixtures are modified in some states to make the asphalt more porous. The Minnesota Department of Transportation (MnDOT) has designed an asphalt mixture (referred to as a permeable asphalt-stabilized stress relief course [PASSRC]) with a modified aggregate gradation to address stripping and consolidation concerns in asphalt separation layers. The Michigan Department of Transportation (MDOT) has also adopted a dense-graded asphalt mixture for separation layers. For more information on the materials used in separation layers, see [Chapter 6](#).

Concrete Mixture Design. Conventional concrete paving mixtures are generally used for unbonded overlays, with the exception of mixtures that incorporate macrofibers or mixtures designed to accommodate an accelerated construction window. When accelerated opening to traffic is desired, conventional concrete mixtures should be proportioned for rapid strength gain. For more information on concrete materials and performance-engineered mixture properties, see [Chapter 6](#).

Joint Design. The load transfer design details for unbonded overlays are similar to those for new concrete pavements, with the understanding that unbonded overlays provide lower joint deflections because of the strong support provided by the existing concrete pavement. In overlays 7 in. thick or more, dowel bars are usually warranted to accommodate heavy truck traffic. Installation of dowels in thinner COC–U overlays can be difficult because of the minimal concrete cover and the possibility that inadequately anchored dowel baskets

may move during paving operations. The size, layout, and coating of the dowel bars should be selected for the specific project's location and traffic levels.

The design of tie bar systems for unbonded overlays should follow the conventional use for concrete pavements 5 in. thick or more. Macrofibers have replaced tie bars across contraction joints in thinner unbonded overlays (4 to 5 in. thick) with short panel sizes, but not across construction joints.

Joint Activation. In thin concrete overlays (4 to 6 in. thick), field observations have shown that some contraction joints may not initially activate and, in some cases, do not activate until many years after construction. Contraction joints that do not activate may lead to unwanted dominant joints (i.e., joints that are much wider than the surrounding joints), increased joint maintenance and repair costs, and negative impacts on concrete overlay performance. For more information on joint spacing strategies to achieve joint activation, see *Optimized Joint Spacing for Concrete Overlays with and without Structural Fiber Reinforcement* (Gross et al. 2019).

Drainage. During the evaluation and design stages of a COC–U overlay, the existing subgrade drainage should be evaluated. If the concrete overlay is exposed to high ambient temperatures and a sudden increase in moisture levels (from, for example, a quick rain shower), the pavement may experience sudden expansion and possible buckling at the joints. During freeze-thaw conditions in wet-weather areas, the entrapped moisture can also lead to durability problems in the aggregate. Overall, excessive moisture can compromise the concrete pavement's structural integrity, rideability, and load-carrying capacity. Additionally, excessive subgrade moisture can soften the subgrade and result in differential movement of the concrete pavement, leading to distress cracking in the unbonded overlay. Steps should be taken to ensure adequate drainage, such as retrofitting edge drains, using free-draining shoulder materials, and daylighting the separation layer on the shoulder. When underdrains are present, they should be cleaned and maintained.

Construction

Important construction elements for unbonded overlays on concrete pavements include pre-overlay repairs, separation layer placement, concrete placement, curing, joint sawing, joint sealing, and opening to traffic. See [Chapter 8](#) for more details on the construction and maintenance tasks noted in this section.

Pre-overlay Repairs. The surface of the existing pavement should be inspected for isolated pockets of deterioration that require repairs. Typically, only distresses that cause a major loss of structural integrity require repair. If distressed areas are not significantly deflecting or moving and the subgrade and subbase are stable, costly repairs are typically not needed, particularly when the overlay slab thickness has been adequately designed and an adequate separation layer is present. Table 5.1 lists possible pre-overlay repairs.

Separation Layer Placement. A well-placed and compacted HMA or a secured and unwrinkled geotextile separation layer helps ensure good performance of the unbonded overlay. Before the separation layer is placed on the existing pavement, the surface should be swept clean of any loose material with either a mechanical sweeper or an air blower. Conventional placement practices and procedures should be followed for placing the separation layer.

Concrete Placement. Conventional concrete paving procedures are followed for placing, spreading, consolidating, and finishing the unbonded overlay. When the surface temperature of the separation layer exceeds 120°F (49°C), spraying the surface with water can reduce the temperature and minimize the chance of early-age cracking. Do not flood the surface with water, which may leave puddles of water prior to paving.

When a black geotextile separation layer is cooled with water, it should be dampened and not saturated. A simple test is to touch the fabric; no water should show on the fingers. Additionally, no standing water should remain on the surface of the geotextile at the time the overlay is placed. To help reduce heat absorption, white

geotextile fabric can be used to help reflect solar energy in hot weather.

Adequately anchoring dowel baskets to the existing concrete pavement is important during placement of the overlay. Alternatively, pavers equipped with dowel bar inserters can be used.

Because of variations in the thickness of the overlay concrete, agencies are encouraged to bid the concrete material on a volume (cubic yard) basis. A bid item for placement is typically measured on a square yard basis. See [Chapter 7](#) for information on estimating and bidding quantities.

Curing. Good curing practices are critical for unbonded concrete overlays, especially for thin unbonded overlays because of their high surface-area-to-volume ratio. Good curing is accomplished by applying a curing compound immediately after surface texturing. The finished product should appear uniformly white like a sheet of paper, with the vertical faces along the edges of the overlay also thoroughly coated.

Joint Sawing. Timely joint sawing is necessary to prevent undesired slab cracking. Transverse and longitudinal joints should be sawed with conventional saws to a depth of T/3. For early-entry sawing, transverse joint sawcut depths should be no less than 1.25 in. Since concrete overlays tend to vary in thickness due to crown and cross-slope corrections, the contractor may need to adjust sawing operations to provide the minimum T/3 depth over the varying pavement thicknesses. Good construction sawing practices and an adequate number of saws can greatly reduce early pavement stresses and help accommodate early opening to traffic.

Table 5.1. Possible pre-overlay repairs on existing concrete pavements in preparation for an unbonded overlay

Existing pavement condition	Possible repairs to consider
Faulting; ≤0.25 in. for geotextile separation layer; ≤0.38 in. for 1 in. asphalt separation layer	None
Faulting; >0.25 in. for geotextile separation layer; >0.38 in. for 1 in. asphalt separation layer	Grind pavement to remove faulting for geotextile or thicker asphalt separation layer
Significant tenting	Full-depth repair
Badly shattered slabs	Full-depth repair
Significant pumping	Full-depth spot repair and drainage improvements
Severe joint spalling	Remove all loose fragments and clean
Spalling less than half of the pavement thickness	Remove spalling and fill with flowable cementitious mixture
Spalling more than half of the pavement thickness	Remove and clean deteriorated joint and fill with 2,000 psi cementitious material
CRCP with punchouts or other severe damage	Full-depth repair

Joint Filling. Joint filling of thinner (4 to 6 in.) unbonded overlays is encouraged in wet-weather states to help prevent early-age buckling.

Opening to Traffic. Recommendations on determining the strength required for opening to traffic can be found in [Chapter 6](#).

Maintenance and Repairs

Recommended repair options for unbonded overlays are the same as those for standard concrete pavements.

Concrete on Concrete—Bonded Overlays

Because the use of COC–B overlays is restricted to pavement in good condition, this type of overlay is only considered in special circumstances and is not nearly as common as other types of concrete overlays. While rare and unique, bonded concrete overlays of concrete pavements are nevertheless viable. Figure 5.4 shows a schematic view of a COC–B overlay.

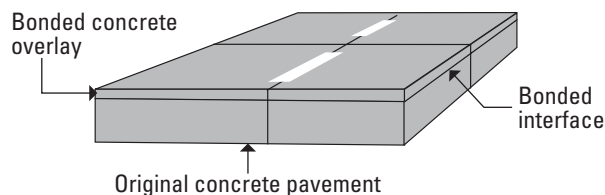

CP Tech Center

Figure 5.4. COC–B overlay

COC–B overlays are relatively thin (typically 2 to 6 in.) concrete layers bonded to an existing concrete pavement surface, which must be in good condition or be able to be cost-effectively improved to good condition, to create a paving layer that acts monolithically (Figure 5.4). The development of a bond between the two layers is directly considered in the overlay thickness design and is, therefore, essential to the performance of the system.

Bonded overlays have been built and used on every type of highway system, from Interstates to local roads (see the ACPA's [National Concrete Overlay Explorer](#) [ACPA 2021]). When designed and constructed correctly, this overlay type provides a means of improving the structural capacity of an existing concrete pavement, particularly when increased traffic is anticipated. Bonded overlays can also cover surface defects such as plastic shrinkage cracks and improve characteristics such as friction, noise, and smoothness.

Because COC–B overlays are considered a specialty item, additional details and case studies are presented in [Appendix C](#).

Chapter 6

Materials and Mixtures

Concrete Material Constituents	44
Cementitious Materials	44
Aggregates	44
Water	44
Admixtures	44
Performance-Engineered Mixture Properties for Overlays	45
Strength	45
Workability	45
Shrinkage	45
Cold Weather Resistance	45
Water-to-Cementitious Materials Ratio	46
Opening Criteria for Concrete Overlays	46
Other Overlay Materials	47
Macrofibers for Concrete Overlays	47
Separation Layer	50
Dowel Bars and Tie Bars	51
Curing Compound	51
Joint Fillers and Sealants	51

Concrete overlays are constructed with conventional concrete paving materials, which include cement, supplementary cementitious materials (SCMs), aggregate, water, chemical admixtures, dowel bars, tie bars, continuous steel reinforcing (for CRCP overlays), curing compounds, and joint fillers or sealants. Concrete overlays can also include macrofibers and separation layers.

As with conventional concrete pavements, an effective mixture design is essential to the performance of a concrete overlay. Each component of the concrete mixture should be carefully selected so that the resulting composite mixture will provide consistent fresh properties for construction, develop specified hardened properties, and resist environmental factors and deleterious chemical reactions over its service life. For more information on concrete mixture design, see [Chapter 7 of the IMCP manual](#).

Concrete Material Constituents

Cementitious Materials

Common paving cements, including Type I and Type II cements (ASTM C150), and SCMs are typically used for concrete overlays. Other blended cements (ASTM C595) and hydraulic cements (ASTM C1157) can also be used. Use of Type III cements for concrete overlays is not recommended due to the risk of increased cracking from drying and thermal shrinkage.

Typical replacement rates of portland cement with SCMs are 15% to 35%, depending on the chemical compositions and types of SCMs used. Commonly used SCMs include Class C fly ash, Class F fly ash, and slag cement. SCMs can improve concrete durability and, in certain combinations with cement, delay setting time. Delayed setting time can facilitate construction during hot weather by extending the concrete placement time and can be critical for thinner concrete overlays and during cooler weather. Delayed setting may also affect the timing of sawcutting operations.

For more information on cementitious materials, refer to [Chapter 4 of the IMCP manual](#) (Taylor et al. 2019).

Aggregates

The aggregate selected should meet the physical and chemical stability criteria for the design life of the project. Similar to the aggregates used in conventional paving materials, the aggregates used in concrete overlays should conform to ASTM C33 in terms of

their physical properties. Overlay mixtures made with a well-graded combined aggregate system have improved workability, minimized paste (cementitious materials and water) requirements, reduced shrinkage, reduced permeability, lower costs, and improved mechanical interlock properties at joints and cracks. The maximum coarse aggregate size should not exceed one-third of the concrete overlay thickness. The improved workability of well-graded concrete mixtures facilitates efficient placement and finishing. For more information on aggregates in concrete mixtures, refer to [Chapter 4 of the IMCP manual](#).

For COC-B overlays, it is important that the aggregate has a coefficient of thermal expansion (CTE) similar to or less than that of the existing pavement. This will ensure that the structural layers deform similarly under temperature changes and will reduce the potential for debonding. For more information on COC-B overlays, refer to [Appendix C](#).

Water

There is no difference in the quality of water used for batching concrete overlays and batching conventional concrete pavement. The water must be free of any impurities that may affect setting time, concrete strength, or any property related to durability. Water from a potable source is acceptable, while water from nonpotable sources or recycled water from concrete production operations should be tested for impurities before using (Taylor et al. 2019).

Admixtures

Various admixtures are commonly used in concrete overlay mixtures. (Refer to [Chapter 4 of the IMCP manual](#) for more detailed information on admixtures.)

Air-entraining admixtures provide freeze-thaw resistance and improve resistance to salt scaling. Air entrainment also increases the workability of concrete mixtures and decreases the risk of segregation and bleeding (Taylor et al. 2019). The agency requirements for the air content of concrete overlays are typically the same as those for conventional concrete.

Water reducers are added to concrete mixtures to reduce the amount of water required to produce concrete of a given consistency. This type of admixture allows for a moderate water-to-cementitious materials (w/cm) ratio to be maintained while achieving a desired workability.

Accelerators are sometimes added during cool weather to accelerate initial and final set. Accelerators should be used with caution in concrete overlays, especially during warmer weather, to ensure that adequate time is available for placing and finishing. For more information on accelerated set times, refer to [Opening Criteria for Concrete Overlays](#) in this chapter.

Set-retarding admixtures are occasionally utilized during hot weather to slow the rate of hydration. They should be used with caution for thin overlays, which could develop shrinkage and random cracks during warm and windy weather when curing is delayed.

Performance-Engineered Mixture Properties for Overlays

Producing a concrete overlay mixture that performs well under expected service and environmental conditions is the primary long-term objective of the mixture design process. Performance-engineered mixtures (PEM) can help define and achieve the desired performance properties for a given mixture. (For a comprehensive overview of PEM, see [Performance-Engineered Mixtures \(PEM\) for Concrete Pavements](#) [Cackler et al. 2017].) PEM focuses on six concrete performance properties that are fundamental for long-term durability: strength, cold weather resistance, aggregate stability, workability, shrinkage, and fluid transport. The four PEM properties critical to concrete overlays are summarized below.

Strength

The strength of a concrete overlay mixture should be similar to that of a conventional paving mixture. For thinner concrete overlays, it is especially important to maintain normal concrete flexural strengths and not specify high-strength materials because doing so may lead to a more brittle concrete surface, increased thermal and moisture shrinkage, and debonding of the overlay from the substrate. The compressive or flexural strength of the overlay should be measured to ensure that the design strength of the mixture is achieved. The addition of macrofibers increases fracture toughness.

Workability

The workability of a concrete overlay mixture should be similar to that of a conventional concrete paving mixture. Workability is influenced by aggregate gradation, mixture proportioning, and placement sequence. For thinner overlays, the addition of macrofibers may require adjustment of the paste content

to ensure adequate fiber dispersion and to facilitate finishing and texturing. Water-reducing admixtures can provide an increase in the workability of the mixture without increasing the water or paste content but may increase the risk of segregation. Although the slump test has been historically used to assess workability, the vibrating Kelly ball (VKelly) and Box Tests are newer testing procedures that indicate how a mixture responds to vibration. Some agencies have found these workability tests to be beneficial during the mixture design phase but not appropriate for acceptance testing during paving. More information on PEM testing for workability can be found at <https://cptechcenter.org/performance-engineered-mixtures-pem/>.

Shrinkage

Concrete overlays can be more susceptible to concrete shrinkage than conventional pavements because of the higher surface-to-volume ratio and the sometimes high level of bond or friction at the slab-support interface. Concrete shrinkage can lead to debonding at the slab-support interface, an increase in the magnitude of moisture curling (differential shrinkage), and premature cracking. The primary factor controlling the shrinkage magnitude of a mixture is the volume of paste. The volume of paste can be reduced by limiting the cementitious materials content and adopting an optimized aggregate gradation. Successful mixes can be achieved with a paste volume of 25% or less. For more information on achieving an optimal paste content, refer to [Chapter 7 of the IMCP manual](#) for a discussion of the void ratio method and absolute volume ratio.

Cold Weather Resistance

Properly designed and constructed concrete overlays that have adequate air content and proper air distribution, low permeability, and the recommended range of SCMs can minimize the risk of joint spalling in cold weather environments. Some agencies have used the Super Air Meter (SAM) to determine the proper air void distribution by correlating the SAM number with the air void spacing factor. The American Concrete Institute (ACI) *Guide to Durable Concrete* (ACI Committee 201 2016) suggests that a spacing factor of 0.008 in. and a specific surface of 600 in.²/in.³ be used to determine whether a concrete is frost susceptible. Information on PEM testing methods for cold weather resistance can be found at <https://cptechcenter.org/performance-engineered-mixtures-pem/>.

The use of SCMs in concrete mixtures can reduce the risk of joint deterioration and spalling caused by calcium oxychlorides that form when certain deicing salts are applied. The reduction in calcium hydroxide content achieved through the addition of SCMs results directly in a reduction in the formation of calcium oxychloride (Weiss et al. 2018).

Water-to-Cementitious Materials Ratio

As with conventional concrete mixtures, the w/cm ratio is a key parameter affecting the workability, strength, permeability, and durability of concrete overlays. The w/cm ratio should typically be between 0.40 and 0.45 for concrete paving mixtures, depending on the local climate and materials. The following are several ways to achieve a moderately low w/cm ratio while maintaining satisfactory workability:

- Using SCMs in appropriate dosages
- Using a combination of aggregate sizes that achieves a well-graded system, which reduces the paste volume for the same level of workability
- Using water-reducing admixtures
- Controlling concrete temperatures. High temperatures can indirectly lead to higher w/cm ratios if water is added with the intention of increasing workability. In cold temperatures, SCMs can reduce set time, but it is important to keep SCMs in the mixture. A replacement of 20% to 40% of cement with SCMs is recommended for mixture temperatures in the range of 65°F to 75°F.

Opening Criteria for Concrete Overlays

When an owner or agency is deciding when to open a pavement to traffic, it is important to understand the minimum strength and amount of time required to reach the opening goal while still achieving the overlay's long-term design strength and durability.

To open pavements earlier to traffic, PEMs are currently being designed that can reach design strengths in a timely manner. However, opening to traffic does not require reaching the design strength. While opening compressive strengths in the range of 3,000 to 4,000 psi have been common historically, research has shown that this magnitude of strength is not required for opening to construction traffic or normal operations because the

concrete will continue to gain strength and ultimately reach the design strength (Roesler et al. 2000).

For example, the Illinois State Toll Highway Authority has utilized an opening compressive strength of approximately 2,000 psi, typically for thicker slabs (10 in.). For concrete overlays, this compressive strength value may be appropriate if the support structure is sufficient. In a more extreme example, a study conducted at MnROAD, TPF-5(341), *Evaluation of Long-Term Impacts of Early Opening of Concrete Pavements*, documented an unloaded snowplow truck driving on a pavement at approximately 73 psi flexural strength with no visible signs of distress. For more information on this study, see the 2019 [draft report](#) (Khazanovich and Li 2019).

Opening strengths and opening times for concrete overlays depend on a number of variables, with overlay thickness and support structure being most important. For example, a thicker overlay can be opened at a lower concrete strength. Other significant factors affecting the opening strength and time are the type and volume of traffic, the dimensions of the slabs, the locations of the loads relative to the edges of the slabs, and the particular cement chemistry and strength gain properties of the mixture. By considering the actual variables from the project, a lower opening strength can be specified without sacrificing overlay performance or adding excessive amounts of cement to reach the design strength at an early age.

Early traffic loading has been shown to assist with joint activation in concrete overlays. Without early traffic loading, certain joints activate earlier than other joints. The joints that activate first open wider than joints that activate later (and are sometimes called “dominant” joints), creating greater movement at the joints that activate first. Early activation of a greater number of joints leads to a smaller amount of movement and contributes to better long-term aggregate interlock and joint alignment. Minnesota has successfully experimented with early joint activation by driving loaded trucks over the pavement at 12 hours to activate the joints.

When a concrete overlay section needs to be opened to construction and/or vehicle traffic quickly (for example, when performing patching repairs or when placing an overlay at an intersection on a heavily trafficked roadway), accelerated or rapid hardening mixtures can be utilized. Some agencies have successfully placed overlays with higher amounts of Type I cement to accomplish quicker strength gain.

Some accelerated mixtures may use Type I cement and SCMs in combinations that are known to have earlier strength gain because of the chemistry and fineness of the materials. Other high-early strength mixtures may have lower w/cm ratios, higher cementitious materials contents, and water-reducing and accelerating admixtures. Other practices to accelerate set times and hardening include increasing the mixture temperature, using cement mixtures without SCMs, and using insulating blankets during early curing.

Pavement engineers should be aware that accelerated or rapid hardening mixtures may undergo more shrinkage and more rapid heat generation than conventional mixtures, which could lead to adverse effects. For example, COA-B overlays may experience some debonding when accelerated or rapid hardening mixtures are used. Best practices for the proper placement of accelerated mixtures include using smaller panels and having a sufficient number of experienced laborers on hand and a sufficient amount of finishing equipment, curing agent, and sawing equipment to accommodate the fast expected setting time.

The maturity method has been successfully applied to monitor and verify the in-place strength of concrete overlays. (For information on the maturity method, see [Chapter 9 of the IMCP manual](#).) Semi-adiabatic calorimetry tests can help engineers evaluate different SCM, cement, and admixture combinations with early setting time and strength gain properties.

Other Overlay Materials

Other overlay materials that may be introduced to the concrete mixture or used as part of the construction process include macrofibers, a separation layer, dowels and tie bars, joint fillers and sealants, and curing compound.

Macrofibers for Concrete Overlays

Since the mid-1980s, FRC has been used successfully for concrete overlays on roadways, with a large increase in use in the past 15 years. Multiple studies involving macrofiber reinforcement in concrete have shown that the flexural and ultimate load capacity of FRC slabs is higher than that of plain, undoweled concrete slabs and that the load transfer efficiency across FRC contraction joints and cracks is higher than that of plain concrete slabs over time. Microfibers can also be a useful additive for concrete overlays to minimize plastic shrinkage cracks;

however, microfibers do not provide any structural capacity to the overlay and are not a substitute for macrofibers. For a detailed overview of the use of FRC for concrete overlays, refer to [*Fiber-Reinforced Concrete for Pavement Overlays: Technical Overview*](#) (Roesler et al. 2019).

The use of macrofibers in concrete overlays has been shown to provide the following measurable benefits:

- Additional structural capacity (allowing thinner concrete slabs or extended pavement service life)
- Reduction in crack widths
- Maintenance of joint or crack load transfer efficiency
- Extension of pavement serviceability through reduced crack deterioration
- Minimal panel migration

The benefits of macrofibers can be illustrated in a study conducted on a 5 in. thick concrete overlay placed on a county highway. One subsection of the concrete overlay contained 4 lb/yd³ of macrofibers, and the other contained no fibers. While both subsections developed reflective cracking, the reflective cracks within the macrofiber-reinforced subsection were held together more tightly than the cracks in the subsection without fibers (Figure 6.1). For more information about the effects of fiber reinforcement on concrete overlays, refer to [*Optimized Joint Spacing for Concrete Overlays with and without Structural Fiber Reinforcement*](#) (Gross et al. 2019).

Macrofiber Material Types

The two primary types of macrofibers used for concrete pavements and overlays are synthetic and steel, with the former being more common. Generally, macrofibers are 1.0 to 2.5 in. in length with an aspect ratio of 30 to 100. Figure 6.2 shows several types of synthetic and steel macrofibers.

Figure 6.3 shows a type of synthetic macrofiber that is twisted together during manufacturing but disperses and separates during mixing into single fiber pieces.

Synthetic macrofibers initially give the surface of the concrete overlay a hairy-looking appearance. This is especially evident if an aggressive texture is applied (Figure 6.4). After the pavement is opened to traffic, the synthetic macrofibers typically wear off.



Snyder & Associates, Inc., used with permission

Figure 6.1. Reflective cracking in an overlay without fibers (top) and in an overlay containing macrofibers (bottom)

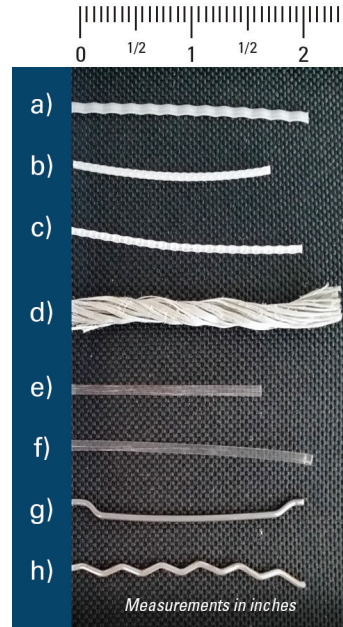

Adapted from Jeffery Roesler, used with permission

Figure 6.2. Types of macrofibers: (a-c) crimped, embossed, or bi-tapered synthetic; (d) twisted synthetic; (e-f) straight fibrillated synthetic; and (g-h) hooked end and crimped steel



Snyder & Associates, Inc., used with permission

Figure 6.3. Synthetic macrofibers



Snyder & Associates, Inc., used with permission

Figure 6.4. Surface texture of concrete overlay with synthetic macrofibers

The required macrofiber content, volume percentage, and dosage rate depend on the specified residual strength value, constituents and proportions, and strength of the concrete. Typical macrofiber dosage rates in concrete overlay applications are between 3 and 8 lb/yd³ for synthetic fibers and 25 to 75 lb/yd³ for steel fibers, or approximately 0.2% to 0.5% by volume (Roesler et al. 2019).

While the residual strength is specified for a particular project and overlay design, distinct macrofiber types require different dosage levels to achieve the same residual strength value. The fibers' geometry, stiffness, and surface characteristics, along with the concrete's strength, all affect the residual strength. Refer to [Appendix A](#) of this guide and *Fiber-Reinforced Concrete for Pavement Overlays: Technical Overview* (Roesler et al. 2019) for more information on incorporating the residual strength of FRC into the concrete overlay design process.

Research has shown that macrofibers can maintain the load transfer efficiency of contraction joints under repeated loading using a mechanism similar to that of tie bars in contraction joints (Barman and Hansen 2018, Barman et al. 2015). However, macrofiber materials should not be substituted for dowel bars to control faulting.

Effects of Macrofibers on the Fresh and Hardened Properties of Concrete

Trial batches are always recommended to confirm the correct sequence of fiber addition during the batching process and to ensure that the FRC mixture can meet all fresh property specifications. Concrete workability, one such fresh property, may decrease with the addition of macrofibers. Generally, the addition of water-reducing admixtures can improve workability, consolidation, and finishing, though occasionally additional paste may be required. The air content of the mixture, another fresh property, may also be affected indirectly by the addition of fibers. The air content can be adjusted through changes in the air-entraining admixture during the trial batches.

Macrofiber balling can occur as a result of any combination of factors, including the properties of macrofiber type selected, the volume fraction of the macrofibers, the mixture's workability, the charging sequence of the mixture's constituents, the type and speed of the concrete mixer, and the condition of the

bins in the mixer system. To minimize balling potential, the fiber manufacturer's recommendations should be followed, which may include adding macrofibers to the mixture before or simultaneously with the aggregates during batching or adding macrofibers directly to the ready mix truck at the job site and mixing for a minimum of 40 revolutions at normal mixing drum speed (Roesler et al. 2019). Macrofibers can be added at the central batch plant, which can be done successfully (completely dispersing the fibers) without increasing the mixing time requirements.

The fiber volume contents used in concrete pavements (<0.5%) are not expected to change the compressive and flexural strengths of the hardened concrete relative to plain concrete. The post-cracking strength (Figure 6.5) and toughness are the primary hardened concrete properties improved by the addition of macrofibers, though the flexural fatigue performance of concrete has also been shown to improve with macrofibers (Roesler et al. 2019).

It is recommended that ASTM C1609 be used to evaluate the residual strength value (f_{150}) for a given concrete mixture, fiber type, and fiber content for concrete pavement overlay design. The [Residual Strength Estimator](#) (CP Tech Center 2019) is a spreadsheet tool that helps pavement engineers select a residual strength value for a given set of concrete overlay inputs. The engineer must input the conditions and design requirements of the project to determine the estimated range of residual strengths for the overlay structural design and to verify that the FRC material requirements are achieved. Because most FRC applications have been bonded overlays of asphalt pavements, the Residual Strength Estimator tool is based on this assumed implication.



Jeffery Roesler, used with permission

Figure 6.5. Post-cracking behavior of a notched FRC beam specimen containing synthetic macrofibers

Separation Layer

A separation layer is an important component of unbonded concrete overlays of existing concrete pavements. The separation layer isolates excessive movement in the two concrete layers and provides a stress relief layer that dissipates horizontal and vertical deformations in the existing concrete pavement system before they are reflected into the concrete overlay and produce premature distresses. Two types of separation layer are commonly used: asphalt and nonwoven geotextile.

Asphalt Separation Layer

A common and successful separation layer used in the US has been conventional asphalt concrete. Typically, a nominally 1 to 2 in. thick layer provides adequate coverage over irregularities in the existing pavement. The thickness of the asphalt separation layer should be minimized to achieve proper density and decrease the risk of additional consolidation. Incorrectly designed HMA separation layers have exhibited stripping and excessive permanent deformation under repeated traffic loading (Cackler 2017). Past issues with asphalt separation layers have been linked to improper asphalt mixture design, poor drainage, and an overstressed asphalt mixture relative to the expected traffic.

In an effort to reduce stripping of the asphalt separation layer, the asphalt mixture is modified in some states to make it more porous. The porous or open-graded HMA mixture is designed to drain water quickly from the interface between the concrete overlay and the underlying pavement. This material design reduces the pore water pressure generated in the asphalt under moving traffic loads and increases the long-term stability of the separation layer, but it requires a lateral conveyance system for the water. Permeable asphalt-stabilized stress relief courses (PASSRCs) have been used in Minnesota and Michigan: MnDOT has a specification for PASSRC, and MDOT has used a special provisional specification for an HMA separation layer.

Nonwoven Geotextile Separation Layer

Nonwoven geotextile separation layers have been used successfully in unbonded concrete overlay applications in the United States since 2008. According to Leykauf and Birmann (2006), geotextiles provide uniform, elastic support to the concrete slabs in the overlay, reducing the stresses that develop due to temperature and moisture gradients. Geotextiles also reduce pumping and minimize the initiation of reflected cracks from the underlying pavement. For an overview of nonwoven

geotextile separation layers, refer to *Performance Assessment of Nonwoven Geotextile Materials Used as a Separation Layer for Unbonded Concrete Overlay of Existing Concrete Pavement Applications in the US* (Cackler 2017). Figures 6.6 and 6.7 show various types of nonwoven geotextile separation layer materials.

More detailed material specifications for a geotextile used as a separation layer for unbonded overlays are listed in *Guide Specifications for Concrete Overlays* (Fick and Harrington 2016), but a summary is provided here. The weight per square yard and thickness should be given when specifying a geotextile separation layer. Typically, the following material specifications are used based on concrete overlay thickness:

<5 in. overlay—13.0 oz/yd² @ 130 mils

≥5 in. overlay—15 oz/yd² @ 170 mils



Dan King, Iowa Concrete Paving Association, used with permission

Figure 6.6. Dark-colored nonwoven geotextile separation layer



Dan King, Iowa Concrete Paving Association, used with permission

Figure 6.7. Light-colored nonwoven geotextile separation layer

Before the concrete overlay is placed, the surface temperature of the geotextile separation layer should not exceed 120°F. Ways to cool the surface include sprinkling with water or using a lighter colored nonwoven geotextile separation layer to help reflect solar energy (darker fabric should not be whitewashed). Geotextile that is cooled with water should be dampened and not saturated. A simple test is to touch the fabric; no water should show on the fingers. Additionally, no standing water should remain on the surface of the geotextile at the time the overlay is placed.

Dowel Bars and Tie Bars

When a concrete overlay relies on dowel bars for joint load transfer, the dowel bars should conform to ASTM A1078. The size, layout, and coating of the dowel bars should be selected for the specific project location and traffic levels. (For more information on the use of dowel bars for load transfer, see *Guide to Dowel Load Transfer Systems for Jointed Concrete Roadway Pavements* [Snyder 2011].) In some overlay projects, dowel bar sizes may be reduced or dowel bars may not be used at all because the existing pavement provides a sufficient amount of support. Additionally, although some agencies have used dowel bars in 6 in. thick concrete overlays, they are typically not used in concrete overlays less than 7 in. thick.

When used in concrete overlays, tie bars are typically Grade 60 billet steel bars meeting ASTM A615 or AASHTO M 31 specifications. No. 4 deformed bars are recommended in most situations that require tie bars, while No. 5 bars are not recommended unless the overlay thickness is 10 in. or more. Tie bars are not recommended for use in concrete overlays less than 5 in. thick. Tie bars are typically spaced 30 in. apart, but greater spacing may be used in some cases. For paved shoulders or widened concrete overlays, tie bars are used at the longitudinal joints at the edges of the existing pavement. Refer to [Appendix A](#) for more information on the use of tie bars for widening and lane additions.

Macrofibers can be used in thin concrete overlays (4 to 6 in.) in lieu of tie bars at contraction joints. Composite high-strength steel (with strengths of up to 100 ksi) and fiber-reinforced polymer (FRP) bars have also been used for tie bars and other slab reinforcing (e.g., in CRCP). However, appropriate design modifications must be made to account for the different properties of these materials.

Curing Compound

Adequate curing is essential for concrete overlays and becomes more critical as the slab thickness decreases. White-pigmented liquid membrane-forming curing compounds (conforming to ASTM C309, ASTM C1315 or AASHTO M 148) are recommended for application to the surface and exposed vertical edges of the pavement soon after the concrete has been placed and textured. The white-pigmented compound should be applied to the pavement in such a way that the coverage is uniformly white like a sheet of paper.

Some agencies have implemented the use of curing compounds containing poly alpha-methylstyrene (PAMS) resin. The use of this type of curing compound has been based on studies showing superior moisture retention properties. Application methods and coverage rates are similar to those for normal, white-pigmented curing compounds. A [typical material specification for PAMS curing compound](#) is available from MnDOT.

Joint Fillers and Sealants

The decision whether to apply joint filler or joint sealant depends on the climate in which the overlay is built, the state agency overseeing the project, and the overlay's slab geometry. The need for joint material depends on whether the design allows for water entering the joint to leave the pavement. Joint filling is the predominant action for short-jointed overlays.

When joint fillers or sealants are applied, the following options are available: use of hot-poured rubberized materials conforming to ASTM D6690 or AASHTO M 301, use of silicone materials conforming to a governing state specification, use of preformed compression seals conforming to ASTM D2628 or AASHTO M 220, or the methods or materials prescribed by a governing state specification.

Chapter 7

Plan Development

Construction Drawings	54
Title Sheet	55
Typical Sections	55
Estimated Quantities	56
Plan and Profile	56
Survey Control Information	57
Maintenance of Traffic	57
Typical Construction Details	60
Details for Overlays in Urban Areas	63
Miscellaneous Details	64
Special Considerations for Continuously Reinforced Concrete Pavement Overlays	65
Construction Specifications	65

Construction Drawings

Construction drawings for concrete overlays do not need to be complex. The location, geometric features, and maintenance of traffic requirements of a given overlay project should dictate the level of design detail that is required in the plans. See [Appendix A](#) for more information about the considerations involved in concrete overlay design.

Asphalt overlay projects on rural roads have historically been successfully designed and constructed from a set of drawings consisting of a limited number of sheets. This same approach is acceptable for concrete overlays in rural locations. In urban or suburban locations, however, especially where vertical and horizontal constraints are present, the plans must include the level of detail and amount of information needed to communicate how the concrete overlay will address these constraints. Refer to [Appendix A](#) for more information about the importance of vertical and horizontal constraints in concrete overlay design.

Because concrete overlay design involves an overlay of an existing pavement, a proposed profile may not need to be included in the drawing set, except when minor cross-section or design profile adjustments are needed in spot locations. To determine whether such adjustments are needed, the pavement design process should include a review of the existing profile and cross-section information to determine the effects of raising the grade on overhead clearances, shoulders, side slopes, intersections, drainage structures, and other geometric features.

It is only necessary to conduct a new survey of the existing pavement when a change in the profile is needed. In such cases, a detailed survey that includes cross sections at multiple lines as well as light detection and ranging (LiDAR) scanning can help minimize concrete quantity overruns. Note that when utilizing LiDAR scanning, it is essential that quality checks are performed.

When stringless pavers are used for overlay construction, additional information is needed in the form of three-dimensional (3D) models or electronic design files. As with LiDAR scanning technology, a quality check of the models should be performed using conventional survey methods to ensure the correct profile and alignment.

The *Guide for the Development of Concrete Overlay Construction Documents* (Gross and Harrington 2018) provides example drawing sheets and construction details that can be referenced when assembling overlay plans. An example index of drawing sheets for a concrete overlay on a rural state route or county road should include, at a minimum, the following:

1. Title sheet
2. Typical sections
3. Estimated quantities
4. Plan and profile
5. Survey control information
6. Maintenance of traffic, including consideration of accelerated construction and staging under traffic
7. Typical construction details, including jointing, pavement widening and paved shoulders, and profile transitions

The key features of these drawing sheets are described in this chapter.

In addition, concrete overlays located in urban areas often face challenges related to vertical and horizontal constraints, roadway access points, curb and gutter sections, and drainage structures. These challenges may require additional drawing sheets and details, such as the following:

1. Intersection layout
2. Right of way/access constraints (may include property lines)
3. Curb and gutter details
4. Utility access details, including adjustments of storm inlets, manholes, etc.

The key features of the curb and gutter and utility access details are described in this chapter.

Finally, additional details may be required for concrete overlays that include the safety edge or involve a change in superelevation. The key features of these details are described in this chapter.

Title Sheet

The title sheet provides the basic project identification information, including the following:

- Project name
- Location map
- Detour map, if applicable
- Mileage summary
- Traffic data
- Index of sheets
- Engineer's certification

Figure 7.1 shows an example title sheet, with the full-size version available as Sheet A.1 in the typical concrete overlay construction plans published by the CP Tech Center.

To balance traffic demands with project constructability, detour delay times should be determined in consideration of the available roadway system in the project vicinity. For example, a 10-minute traffic delay by detour may be expected for sites with a short (1 to 3 mi) roadway grid system, while a 20-minute delay may be expected for sites without a closely spaced roadway grid system.

Typical Sections

The typical sections provided in the construction drawings include the existing pavement section, a milling section (when necessary), and the proposed pavement section showing the concrete overlay and any adjustments to shoulders and appurtenant structures. Key features of the typical sections include overlay thickness, lane width, cross slope, shoulder width, shoulder cross slope, and station limits for the overlay section.

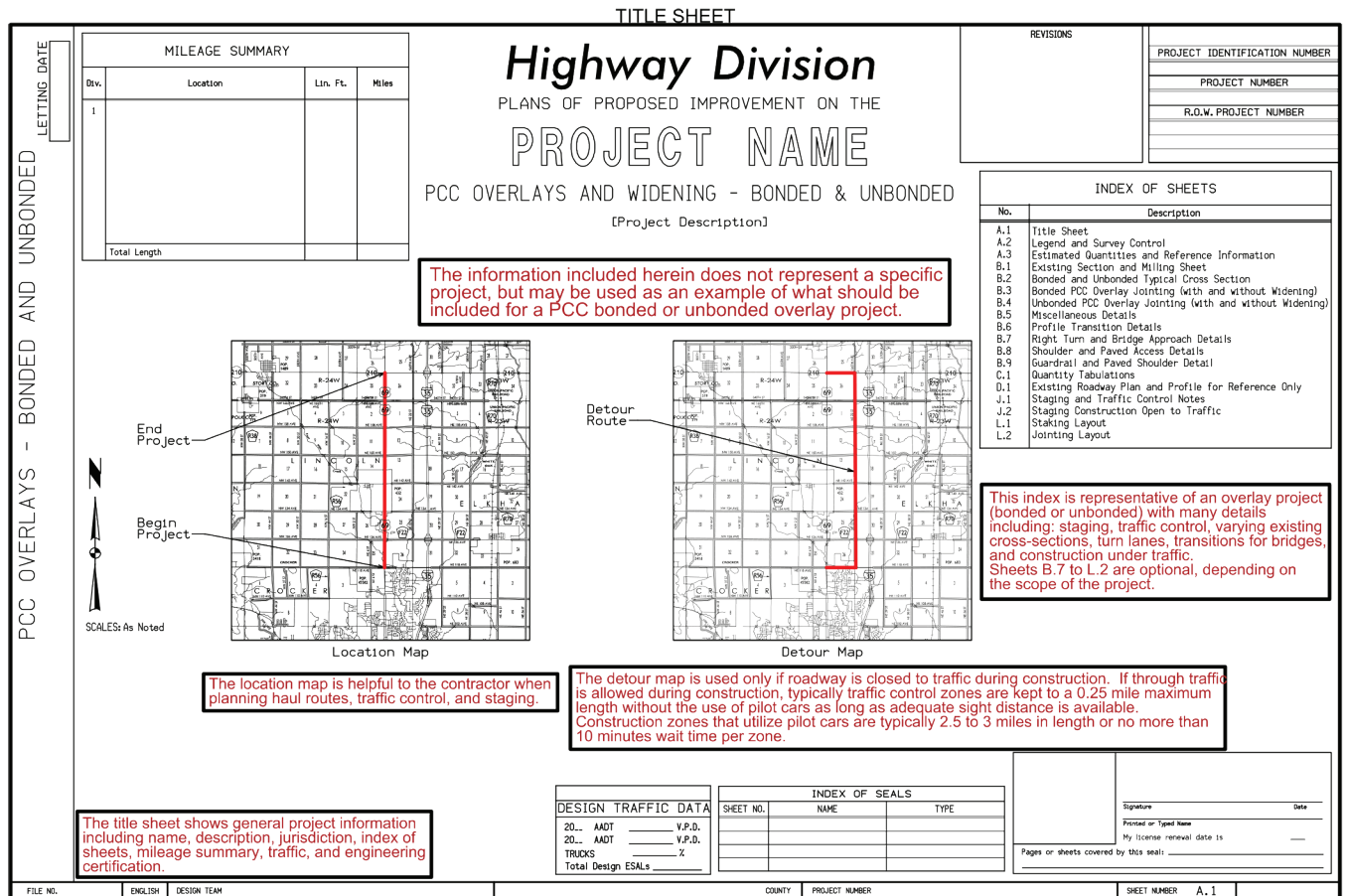

FILE NO.	ENGLISH DESIGN TEAM	COUNTY	PROJECT NUMBER	SHEET NUMBER	A.1
----------	---------------------	--------	----------------	--------------	-----

Snyder & Associates, Inc., used with permission

Figure 7.1. Title sheet

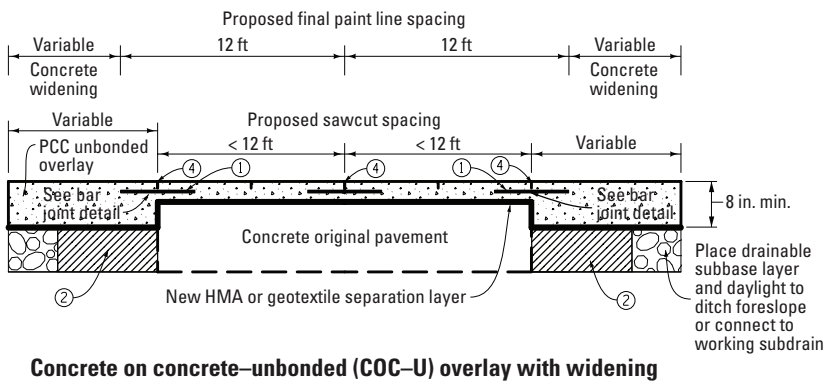

Key:

- ① Consideration shall be given to placement of epoxy coated tie bar at mid-depth. Placement must allow adequate overlay thickness to accommodate maximum sized aggregate under the bar and minimum 2 in. above the bar. If overlay is < 5 in., or placement at mid-depth is not possible, secure tie bar to pavement using a minimum of three staples or epoxy. Tie bars are No. 4 bars 36 in. long at 30 in. centers.
- ⊕ Existing widening unit:
If asphalt, remove unit.
If concrete, unit may remain if stable and 3 ft wide.
If no widening unit, excavate and place drainable subbase.
- ③ Nonwoven geotextile shall either daylight to ditch foreslope, terminate above drainable subbase or connect to working subdrain.
- ④ T/3 (do not sever bar)
- ⑤ An option is to place nonwoven geotextile prior to HMA separation layer.

Concrete on concrete-unbonded (COC-U) overlay with widening

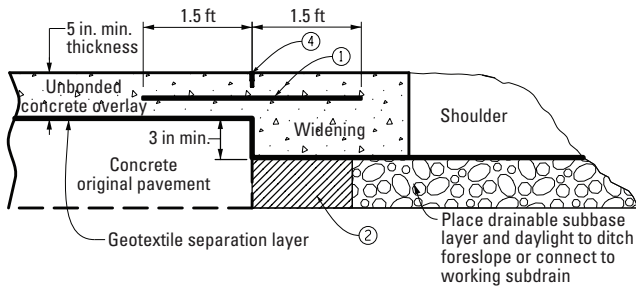

**COC-U widening detail
Nonwoven geotextile separation layer for widening unit**

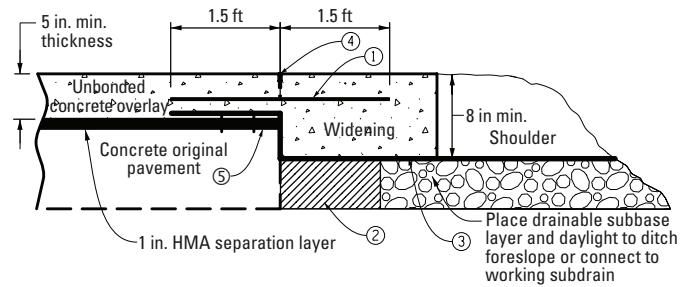

**COC-U widening detail
HMA separation layer and nonwoven geotextile for widening unit**

Recreated from Snyder & Associates, Inc., used with permission

Figure 7.2. Unbonded concrete overlay on concrete with widening (paved shoulders)

Figure 7.2 shows an example of a typical section for a COC-U overlay, with the full-size version available as [Sheet B.4](#) in the typical concrete overlay construction plans published by the CP Tech Center. Other typical sections for bonded and unbonded overlays are available on [Sheet B.2](#) in the typical concrete overlay construction plans published by the CP Tech Center.

Estimated Quantities

The estimated quantities sheet lists the bid item quantities for the overlay project. Typically, each specific bid item number is referenced to an agency specification number. Some agencies include reference information with the estimate that describes the basis of the quantities and provides references to construction details and tabulations when these are included in the drawing set.

It is generally good practice to include two bid items for the concrete overlay. One bid item for furnishing concrete material is measured in cubic yards, and one bid item for concrete placement or paving is measured in square yards. By establishing a bid item for furnishing concrete by volume, there is less risk to the contractor and bid prices may be more competitive. Some states

utilize only one bid item for the concrete overlay in square yards, which may assign more risk to the agency in the form of higher bid prices. This risk may be minimized if profile milling is part of the project, which establishes better control of the concrete quantities. For alternate bid projects, overlay projects should follow [FHWA Technical Advisory 5040.30](#) (FHWA 2019).

Figure 7.3 shows an example estimated quantities sheet, with the full-size version available as [Sheet A.3](#) in the typical concrete overlay construction plans published by the CP Tech Center.

Plan and Profile

Although typically not required as a drawing sheet, the existing pavement plan and profile, along with supplemental survey information (if needed), may be provided as a reference sheet. The design plan and profile information is also typically not required as a drawing sheet unless the project involves cross-slope or profile adjustments. An additional review should be completed and construction drawings updated prior to the bid letting to ensure that existing pavement conditions have not changed since the design was completed.

ESTIMATED QUANTITIES AND REFERENCE INFORMATION

ESTIMATED PROJECT QUANTITIES				ESTIMATE REFERENCE INFORMATION			
ITEM NO.	ITEM	UNIT	ESTIMATED QUANTITIES			ITEM NO.	DESCRIPTION
			Division 1	Division 2	TOTAL		
1	EMBANKMENT-IN-PLACE	CY	1,121.0	123.0	1,844.0	9	PAVEMENT MILLING Profile milling will be required on this project, refer to Typical on sheet B.1 for locations and details. For unbonded or bonded overlays on asphalt or composite pavement. Meet the following requirements for profile milling: 1. Pavement milling equipment shall be equipped with automatic horizontal and vertical controls capable of milling existing pavement to an elevation corresponding to the approved profile grade and cross slope with a tolerance of 0 to -0.5 foot. 2. The contractor will achieve a milled surface for 100% of the pavement surface. The contractor is required to scarf the pavement surface in areas that the mill did not initially touch due to the profile. Profile milling and profile design will consist of the requirements of the Standard Specifications.
2	TOPSOIL, FURNISH AND SPREAD	CY	680	0	680	10	BRIDGE APPROACH Refer to Typical on sheet B.7.
3	TOPSOIL, STRIP, SALVAGE AND SPREAD	CY	363.0	111.0	474.0	11*	SEPARATION LAYER HMA *Choose a separation layer type for PCC unbonded overlay over concrete.
4	GRANULAR SHOULDERS	TON	6,302.0	1,690.0	8,592.0	12*	SEPARATION LAYER - GEOTEXTILE
5	PAVED SHOULDER, HOT MIX ASPHALT MIXTURE, 6 IN.	SY	1,423.5		1,423.5	13	AGGREGATE, COVER - SAND - NOTE: CONSIDER GEOTEXTILE IN LIEU OF SAND The item quantity is for 2 applications and is based on 128 sq. yds. at a rate of 10 pounds per square yard per application. Place on existing PCC patches for unbonded overlay.
6	SHOULDER CONSTRUCTION, EARTH	STA	16.0	5.10	15.30	14	BINDER BITUMEN, CRS-2 - NOTE: CONSIDER GEOTEXTILE IN LIEU OF BINDER The item quantity is for 2 applications and is based on 810 gallons per square yard per application.
7	PATCHES, FULL-DEPTH REPAIR	SY	16.0	32.0	48.0	15	PORTLAND CEMENT CONCRETE OVERLAY, FURNISH ONLY Quantity Increase 10% for Irregularities. Refer to Typical on sheet B.2. Measurement shall be the quantity shown in the contract documents. The basis of payment will be as indicated in specifications.
8	PATCHES BY COUNT (REPAIR)	EACH	2	4	6	16	PORTLAND CEMENT CONCRETE OVERLAY, PLACEMENT ONLY Refer to Typical on sheets B.2, B.3 and the Specifications.
9	PAVEMENT MILLING	SY	58,659.0	25,292.0	83,951.0	17	SUBGRAIN, DRIVEWAY, CRUSHED STONE
10	BRIDGE APPROACH	SY	198.9		198.9	18	SUBGRAIN LONGITUDINAL, (SHOULDER) 4 IN. DIA. Refer to Tabulation on sheet C.1. Approximately 2734 cu.yds. of trench material from the subdrain installation shall be disposed of by the contractor as per the Specifications.
11	SEPARATION LAYER HMA*	SY	10,101.00		10,101.00	20	REMOVAL OF STEEL BEAM GUARDRAIL Refer to Tabulation on sheet B.9.
12	SEPARATION LAYER - GEOTEXTILE*	SY	10,101.00		10,101.00	21	STEEL BEAM GUARDRAIL REMOVAL OF PAVEMENT Refer to Tabulation on sheet C.1. The contractor to dispose of removed pavement as per the standard Specifications.
13	AGGREGATE, COVER - SAND	TON	1.0	0.3	1.3	22	SAFETY CLOSURE Refer to Tabulation on sheet C.1.
14	BINDER BITUMEN, CRS-2	SAL	19.2	6.4	25.6	24	FIELD OFFICE
15	PORTLAND CEMENT CONCRETE OVERLAY, FURNISH ONLY	CY	16,994.0	7,283.0	24,277.0	25	CONSTRUCTION SURVEY This item does NOT include existing monument or centerline point preservation work which was done previously by others.
16	PORTLAND CEMENT CONCRETE OVERLAY, PLACEMENT ONLY	SY	87,180.0	37,450.0	124,630.0	26	PAINTED PAVEMENT MARKING
17	SURFACING, DRIVEWAY, CRUSHED STONE	TON	26.0	22.0	48.0	27	PAVEMENT MARKINGS REMOVED Refer to Tabulation on sheet C.1.
18	SUBGRAIN, LONGITUDINAL, (SHOULDER) 4 IN. DIA.	LF	27,783.0	9,875.0	37,658.0	28	TRAFFIC CONTROL Refer to the Traffic Control Plan, Tabulation sheet C.1.
19	SUBGRAIN OUTLET	EACH	122	46	168	29	FLAGGERS - (use when project is constructed open to traffic)
20	REMOVAL OF STEEL BEAM GUARDRAIL	LF	825.0		825.0	30	PILOT CARS - (use when project is constructed open to traffic)
21	STEEL BEAM GUARDRAIL	LF	1		1	31	MOBILIZATION
22	REMOVAL OF PAVEMENT	EACH	1		1	32	MOBILIZATION, EROSION CONTROL
23	SAFETY CLOSURE	EACH	1		1		
24	FIELD OFFICE	EACH	1		1		
25	CONSTRUCTION SURVEY	LS	0.74	0.26	1.0		
26	PAINTED PAVEMENT MARKING	STA	1,254.85	494.44	1,749.29		
27	PAVEMENT MARKINGS REMOVED	STA	1.70		1.70		
28	TRAFFIC CONTROL	LS	0.74	0.26	1.0		
29	FLAGGERS	EACH	20.0		20.0		
30	PILOT CARS	EACH	10.0		10.0		
31	MOBILIZATION	LS	0.74	0.26	1.0		
32	MOBILIZATION, EROSION CONTROL	EACH	1		1		

ESTIMATE REFERENCE INFORMATION	
ITEM NO.	DESCRIPTION
1	EMBANKMENT-IN-PLACE Item Includes 519 cu. yds for the culvert repairs, 988 cu. yds. for the guardrail grading, and 277 cu. yds. for the right turn lane. Material used for this bid item shall be obtained by the contractor and free of debris. No payment for overhaul will be allowed.
2	TOPSOIL, FURNISH AND SPREAD
3	TOPSOIL, STRIP, SALVAGE AND SPREAD Quantity based on right turn lane work area.
4	GRANULAR SHOULDERS Item Includes 1500 tons for shoulders on sheet B.8, 807 tons for the right turn lanes, refer to sheet B.7, Quantity Increased 10% for shoulder Irregularities.
5	PAVED SHOULDER, HOT MIX ASPHALT MIXTURE, 6 IN. Item Includes 1255.5 sq. yds. for shoulders as per sheet B.8
6	SHOULDER CONSTRUCTION, EARTH Item Includes 12.9 stations for the right turn lanes, refer to Typical on sheet B.8.
7	PATCHES, FULL-DEPTH REPAIR
8	PATCHES BY COUNT (REPAIR) Refer to Tabulation on sheet C.1.

This sheet lists the estimated quantities for the project. Reference is made to the tabulations, specific details, or other sheets where necessary.		Some items may be eliminated based on the specifics of the project.	
Projects are sometimes separated into divisions to track quantities and payment. For example, Division 1 is funded separately than Division 2 on this sample project.		The existing longitudinal subdrains shall remain functional at all times. Any damage to these tile lines or outlets due to the carelessness of the contractor, will be replaced at their expense with no cost to the Owner.	
		The contractor to note that a profile grade is not being provided and that he/she will be required to cross section the roadway and design a profile grade as stated in the Standard Specifications.	

ENGLISH	IOWA DOT	DESIGN TEAM	COUNTY	PROJECT NUMBER	SHEET NUMBER	A_3
---------	----------	-------------	--------	----------------	--------------	-----

Snyder & Associates, Inc., used with permission

Figure 7.3. Estimated quantities sheet

Survey Control Information

Survey control information for project location reference may be included as a drawing sheet or provided separately for reference. This information is necessary to locate the project limits and is used to set construction stakes or, for stringless paving, to develop the design profile using a three-dimensional model. The survey information includes control points, alignment, curve data, and sometimes existing pavement elevations. If changes in the profile are not required or if the ride quality of the existing pavement does not require improvement, it is not necessary to conduct a new survey of the existing pavement.

Figure 7.4 shows an example survey control information sheet, with the full-size version available as Sheet A.2 in the typical concrete overlay construction plans published by the CP Tech Center.

Maintenance of Traffic

If a road closure is not practical due to insufficient detour routes, alternative maintenance of traffic schemes

should be analyzed and included in the construction drawings. In addition, advance planning should be completed and project details should be tailored to facilitate shortened construction durations.

A primary goal during concrete overlay construction is to maintain successful traffic management throughout the duration of the project. The plans and specifications should therefore provide the contractor with clear criteria for maintenance of traffic requirements. Some examples of maintenance of traffic criteria include the following:

- A specified number of lanes must be open in each direction at all times.
- Pilot car queues must not exceed a specified amount of time.
- Predefined critical milestone dates must be met.
- Closures must be limited.
- Access must be provided to local businesses and private properties.

LEGEND AND SURVEY CONTROL

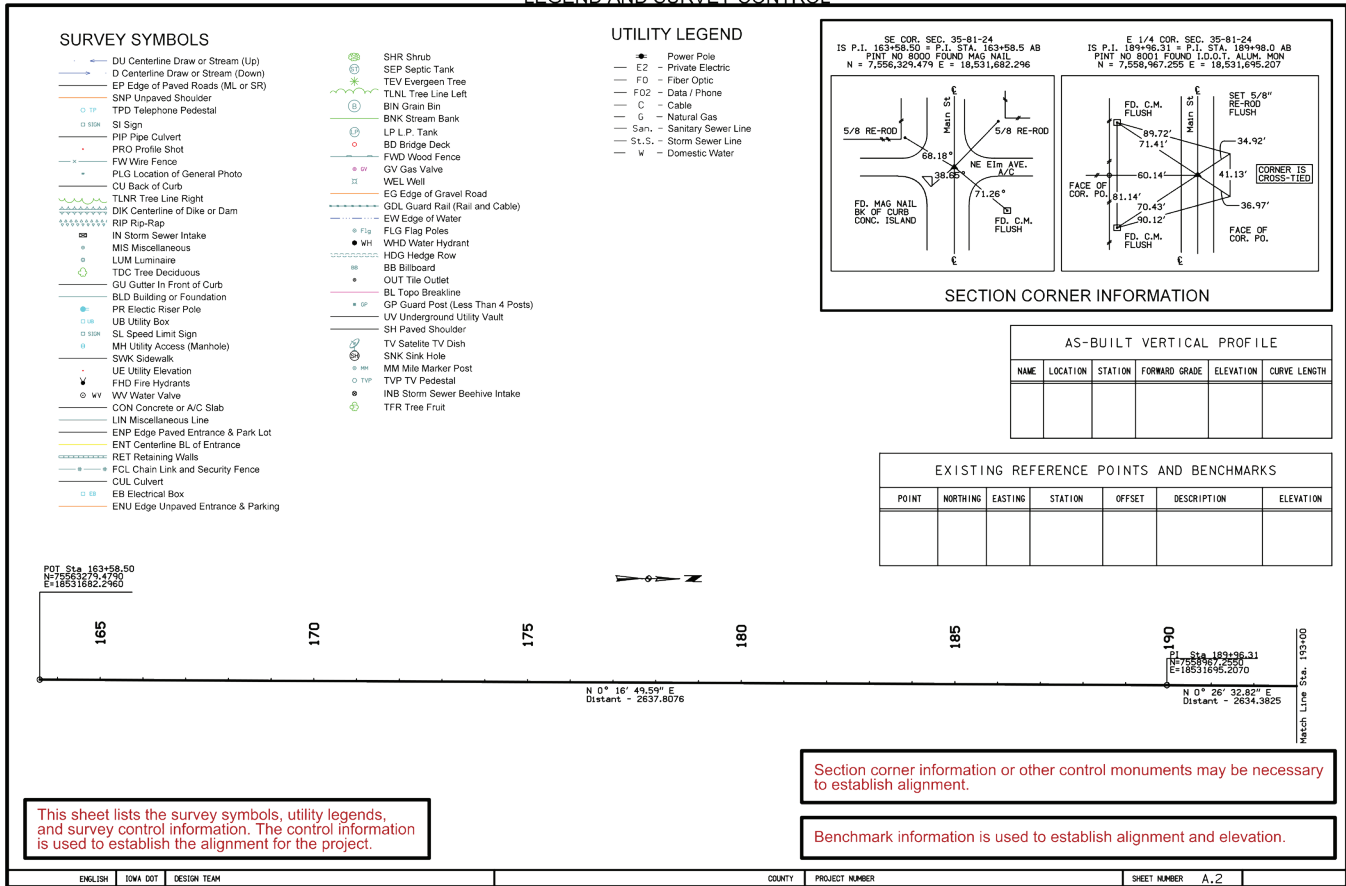

Snyder & Associates, Inc., used with permission

Figure 7.4. Survey control information sheet

With the requirements for maintenance of traffic provided in the plans, the contractor should be given the responsibility to stage and execute the project to meet the objectives for both construction and maintenance of traffic.

Decisions concerning maintenance of traffic often depend, at least in part, on the thickness of the concrete overlay and the width of the pavement. If pavement edge drop-off criteria are exceeded, maintenance of traffic should be similar to that used for full-depth portland cement concrete reconstruction. If pavement edge drop-off criteria are not exceeded, maintenance of traffic should be similar to that used for other thin overlay projects.

Figure 7.5 shows an example sheet outlining traffic control and staging notes, with the full-size version available as Sheet J.1 in the typical concrete overlay construction plans published by the CP Tech Center.

Two important considerations when developing maintenance of traffic schemes include accelerated construction methods and staging under traffic.

Accelerated Construction

By their nature, concrete overlays involve accelerated construction. The existing pavement is reused in place with minimal disturbance, and the subgrade is never exposed to weather. Overall, the total construction duration is typically one-quarter to one-third that of a reconstruction project. One of the significant benefits of concrete overlay construction is this decrease in total construction time, which reduces road user costs and increases driver safety. In addition, concrete overlays offer confidence that the improvements will provide a long-life pavement. For more information on the benefits of accelerated construction, see the FHWA's compilation of resources (FHWA 2018).

Concrete overlay construction can be further accelerated through various means. When deciding whether accelerated construction techniques are to be implemented on a concrete overlay project, it is important that benefits can be gained in terms of reduced road user costs and delays. The specific implementation of accelerated construction techniques on a concrete overlay project is based on the needs of the project and of road users.

STAGING AND TRAFFIC CONTROL NOTES

STAGING NOTES	TRAFFIC CONTROL PLAN
<ol style="list-style-type: none"> ① Through traffic on Mainline shall be staged to allow work under traffic and work while detoured. Mainline detour route (refer to map on sheet A.1) shall be signed and maintained by the jurisdiction Maintenance personnel. The contractor shall provide a 2 week notice to the engineer before any detour use is allowed. ② The contractor shall maintain access at all times for residents who live and work along mainline, including school bus traffic. No more than two (2) side roads closed at any time. ③ Traffic control on the project shall be in accordance with MUTCD, current edition. ④ Unless otherwise directed, the contractor shall take appropriate measurements of the existing pavement marking prior to removing or obliterating them to insure their replacements are positioned in similar locations. ⑤ If Mainline is open to traffic, no lane closures will be allowed during the following events: 	<p>STAGE 1 TRAFFIC CONTROL A minimum of one traffic lane shall be maintained on Mainline during daytime hours. During night time hours lane closures will not be allowed.</p> <p>CONSTRUCTION Full Depth Patching Pavement Milling</p> <p>STAGE 2 Phase 2A TRAFFIC CONTROL Through traffic on Mainline shall be detoured (refer to Detour #1 map on sheet A.1).</p> <p>CONSTRUCTION Excavation for PCC Widening and Subbase Placement PCC Inlay Pavement / PCC Reconstruction Areas / PCC Overlay Pavement Right turn lane construction PCC / HMA tie-in work at side roads Granular Shoulders Guardrail updates Pavement Markings</p> <p>Phase 2B TRAFFIC CONTROL Through traffic on Mainline shall be detoured</p> <p>CONSTRUCTION Excavation for PCC Widening and Subbase Placement PCC Overlay and Widening / PCC Reconstruction Areas Right turn lane construction PCC / HMA tie-in work at side roads Granular Shoulders Paved Shoulders Guardrail updates Pavement Markings</p>
<p style="text-align: center;">COORDINATED OPERATIONS</p> <p>Other work in progress during the same period of time will include the construction of the projects listed. Coordinate operations with those of other contractors working within the same area.</p>	
<p>This sheet is required to list specific staging notes and criteria that the contractor will need to follow during construction. If specific staging or phasing is required, it is recommended to list specific staging criteria instead of drawing detailed staging plans. This gives the contractor flexibility in setting up staging operations and possibly making construction operations more efficient. It is critical that the contractor submits traffic control and staging plans for review prior to construction.</p>	<p style="text-align: right;">OPTIONAL STAGING AND TRAFFIC CONTROL</p>
<p>ENGLISH IOWA DOT DESIGN TEAM</p>	<p>COUNTY PROJECT NUMBER SHEET NUMBER J.1</p>

Snyder & Associates, Inc., used with permission

Figure 7.5. Sheet outlining traffic control and staging notes

Accelerated construction techniques may be used for critical parts of a project (such as intersections and crossovers), the final segment, or the entire project.

Accelerated construction often involves conventional concrete pavement materials and procedures, but key changes to conventional practices can significantly expedite projects. These changes can give the contractor the flexibility needed to meet aggressive schedule demands. The changes to conventional practices that can accelerate construction often involve the following:

- Contract incentives
- Modification of pavement equipment for minimum to zero clearance
- Material proportioning modifications
- Accelerated curing methods
- Alternative construction staging
- Approved changes to pavement joint layouts to facilitate maximum use of slipform placements
- Adjustments to the criteria for opening to traffic

Additionally, for some critical projects, accelerated concrete mixtures are used for concrete overlays.

The following are the most common and most effective items for accelerating concrete overlay projects:

- Well-planned staging and maintenance of traffic criteria
- Public relations efforts that involve coordinating with adjacent businesses and residents to optimize access and constructability
- Implementation of time-related incentives and disincentives to encourage concurrent scheduling and timely completion
- Use of accelerated concrete mixtures, but only mixtures for which the time to opening to traffic falls on the critical path
- Accelerated curing through the use of insulating blankets
- Use of the maturity method to determine early opening (see Chapter 9 of the IMCP manual)

Staging under Traffic

Stringless pavers and zero-offset pavers allow the contractor more flexibility than conventional pavers in addressing maintenance of traffic during paving operations. However, it is important that the construction documents do not dictate the types of equipment or methods needed for construction, because such restrictions may unnecessarily inhibit competition and result in a more costly project. Instead, the project documents should reflect the requirements for successful construction, including the minimum clearance zone needed to accommodate traffic and traffic control devices.

Various staging sequence diagrams are available for reference in [Appendix D](#) that illustrate different traffic control scenarios when constructing a concrete overlay without closing the road to traffic:

- Two-lane roadway with paved shoulders (conventional paver)
- Two-lane roadway with granular shoulders (conventional paver)
- Two-lane roadway with minimum granular shoulders (zero-clearance paver)
- Two-lane roadway widened to three lanes with paved shoulders (conventional paver)
- Four-lane roadway with paved shoulders (conventional paver)

Typical Construction Details

Construction details in the drawing set provide the contractor with critical information beyond what is included in the typical sections. At a minimum, construction details should include jointing, pavement widening, and profile transitions.

Jointing

The panel dimensions determined during the design phase can be illustrated using a plan view joint layout detail. The joint layout detail should also illustrate reinforcing steel locations and widening units, if applicable.

Figure 7.6 shows an example joint layout detail in plan view, with the full-size version available on [Sheet B.4](#) in the typical concrete overlay construction plans published by the CP Tech Center. Another example is provided in a [typical overlay joint layout](#) developed by the Colorado Department of Transportation.

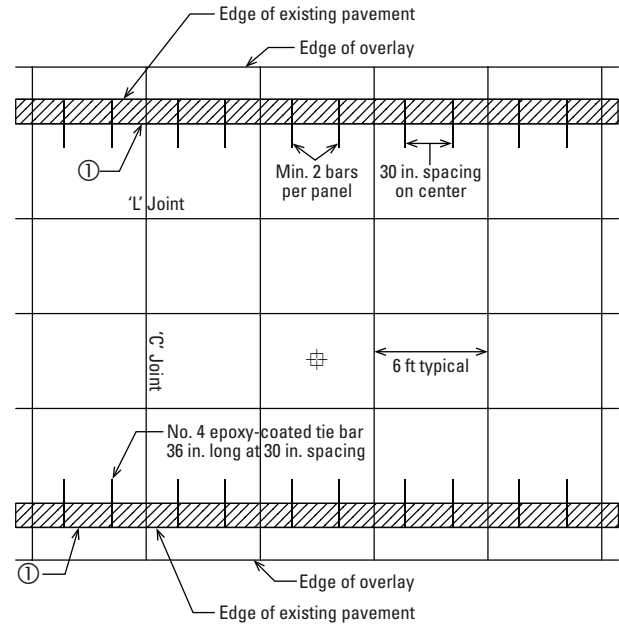

Notes: Dimensions of panels may change based on project specifics
L= Longitudinal joint (T/3)
C= Sawed transverse joint (T/3)

- ① Existing widening unit:
If asphalt, remove unit.
If concrete, unit may remain if stable and 3 ft wide.
If no widening unit, excavate and place drainable subbase.
- ⊕ For unbonded overlays equal to or less than 6 in. thick, maximum joint spacing in feet is 1.5 times the overlay thickness in inches. For unbonded overlays greater than 6 in. thick, maximum joint spacing in feet is 2 times the overlay thickness in inches. Maximum recommended spacing is 15 ft.

Recreated from Snyder & Associates, Inc., used with permission

Figure 7.6. Plan view joint layout detail for an unbonded overlay with widening

For jointing in COC–B overlays, it is critical to match the locations of the transverse and longitudinal joints in the concrete overlay with the locations of the transverse and longitudinal joints in the existing concrete. The transverse and longitudinal sawcuts must be to the full depth of the overlay plus ½ in. Tie bars, dowel bars, or other embedded steel products are not used in COC–B overlays to minimize restraint forces in the bond.

In COC–B overlays, it is also critical to examine the widths of the cracks below the sawcuts in the existing pavement. The sawcut widths of the concrete overlay should be equal to or greater than the crack widths in the existing pavement (see [Appendix A](#)). This concept is illustrated in Figure 7.7, which shows a joint detail for a COC–B overlay. The full-size version is available on [Sheet B.3](#) in the typical concrete overlay construction plans published by the CP Tech Center.

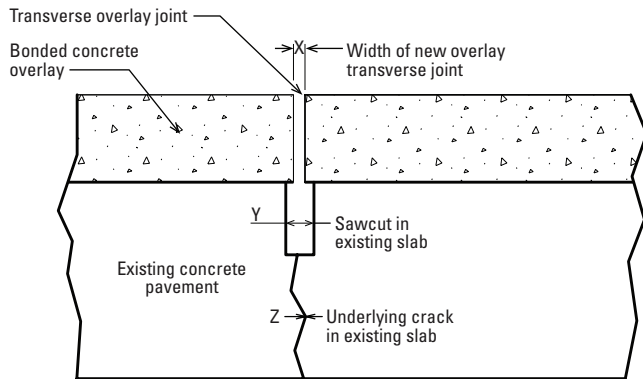

Note: Overlay joint width shall be equal to or greater than crack width of the existing slab. If "Y" is 0.50 in. or greater, the underlying crack width in the existing slab should be measured. If crack "Z" is 0.25 in. or greater, and existing pavement does not have dowel bars, the joints should be evaluated to determine if load transfer rehabilitation is required to eliminate faulting. If there are numerous joints with this condition, the existing pavement may not be a good candidate for a bonded overlay. The existing joints should be filled/sealed to prevent intrusion of mortar during overlay placement. In all cases, "X" must be $Z+0.125$ in.

Recreated from Snyder & Associates, Inc., used with permission

Figure 7.7. COC-B joint detail showing the widths of the overlay joint, sawcut, and underlying crack

Pavement Widening

For concrete overlay widening, special details are needed to illustrate the widening unit and treatment of the existing pavement and shoulder. The following recommendations are given for reinforcing steel, improved drainage, and treatment of a widening unit in the existing pavement:

1. **Reinforcing steel.** No. 4 deformed bars are recommended as the maximum size tie bars at the widening unit to minimize the potential for the development of a longitudinal crack and to hold tight any crack that might develop. Some agencies have observed random cracking when No. 5 tie bars have been used. If the overlay is greater than 5 in. thick, consideration should be given to placing the bars at the mid-depth of the slab. The bars must be placed so as to accommodate the maximum aggregate size under the bar and to provide a minimum of 2 in. of concrete above the bar. If the overlay is less than 5 in. thick, the bars may be secured to the surface of the existing pavement prior to placement of the overlay.
2. **Improved drainage.** It is recommended that drainage conditions be improved in the widening unit by incorporating a drainable subbase layer or, in the case of a COC-U overlay, by daylighting the separation layer material to the edge of the roadway or into a working subdrain.

3. **Treatment of a widening unit in the existing pavement.** If the existing pavement has a widening unit, consideration should be given to its removal if it is concrete and less than 3 ft in width or if it is asphalt. If the existing widening unit is concrete, 3 ft wide or wider, and stable, it can remain in place. For recommended solutions to minimize pavement widening distress, refer to Figures 17.5, 17.6, 18.3, and 18.4 in the *Guide for Concrete Pavement Distress Assessments and Solutions* (Harrington et al. 2018).

Example widening details are shown in Figure 7.8 for COC-B and COA-B overlays and in Figure 7.9 for COC-U and COA-U overlays. The full-size versions of these details are available as [Sheets B.3](#) and [Sheet B.4](#), respectively, in the typical concrete overlay construction plans published by the CP Tech Center.

Profile Transitions

Vertical profile transitions are required at the beginning and end of concrete overlay pavement sections, at transitions into bridge approaches, and under structures where vertical clearance must be maintained. These transitions can be accomplished in various ways, but vertical profile transitions at bridge approaches always require full-depth pavement removal and replacement. Additionally, for transitions on COC-B overlays where milling is performed, it is critical that milling depth does not reach existing embedded steel. The rate of vertical transition is dependent on the posted speed limit. A 40:1 vertical taper is recommended for a speed limit of 45 mph or greater. A 25:1 vertical taper is recommended for speed limits less than 40 mph.

Figures 7.10 through 7.13 show examples of profile transition details for the following scenarios:

- Mill and fill profile transitions for bonded concrete overlays on end transition (Figure 7.10)
- Transition for a COA-B overlay (Figure 7.11)
- Temporary transitions (Figure 7.12)
- Transition for a COA-U overlay (Figure 7.13)

The full-size versions of these details are available on [Sheet B.6](#) in the typical concrete overlay construction plans published by the CP Tech Center.

BONDED PCC OVERLAY JOINTING (WITH AND WITHOUT WIDENING)

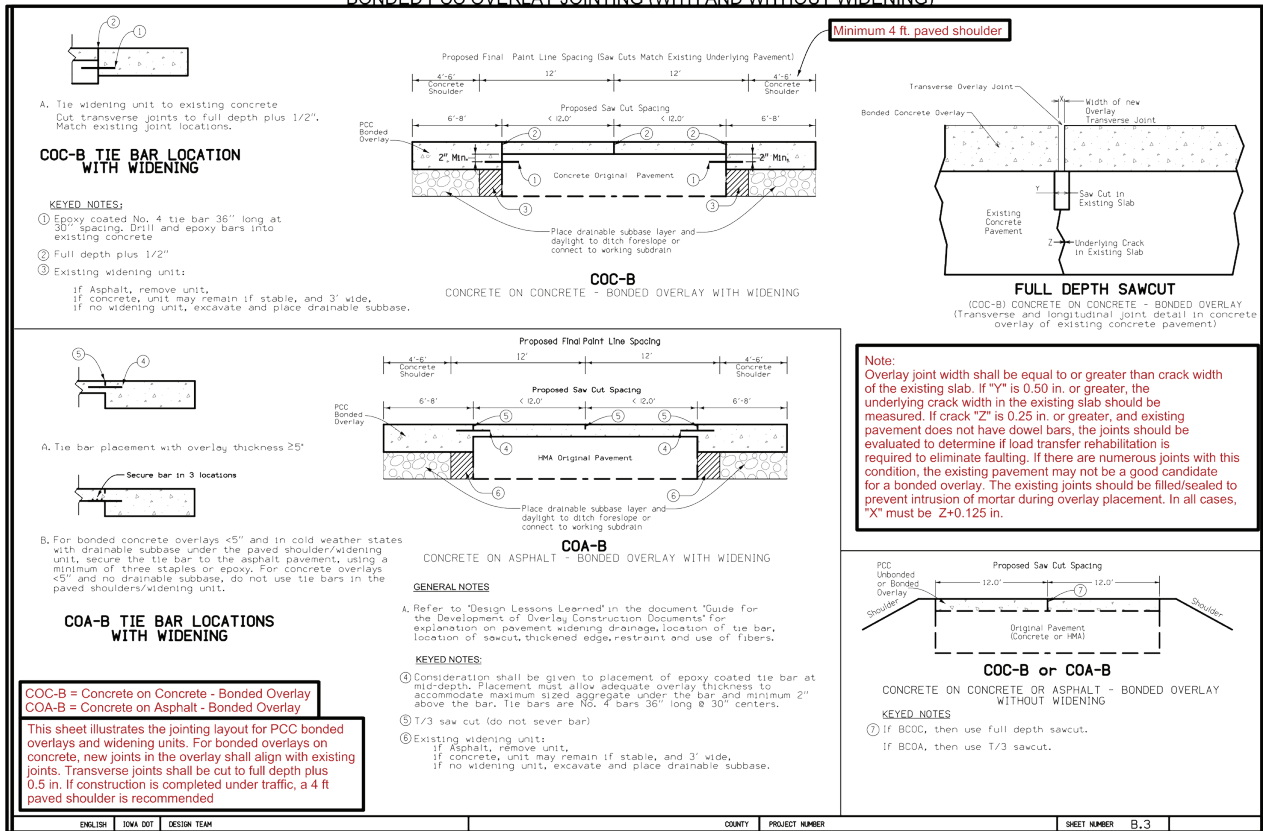

Snyder & Associates, Inc., used with permission

Figure 7.8. Widening details for COC-B and COA-B overlays

UNBONDED PCC OVERLAY JOINTING (WITH AND WITHOUT WIDENING)

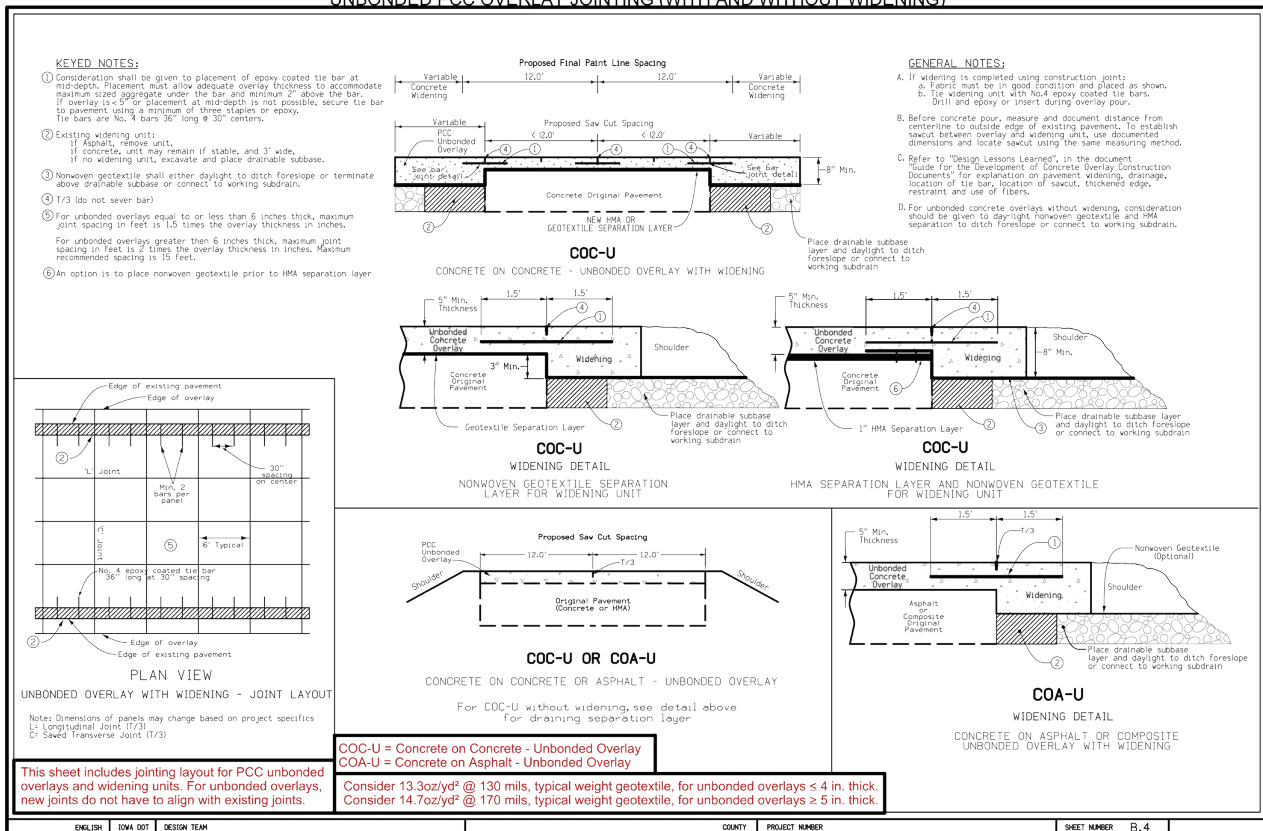

Snyder & Associates, Inc., used with permission

Figure 7.9. Widening details for COC-U and COA-U overlays

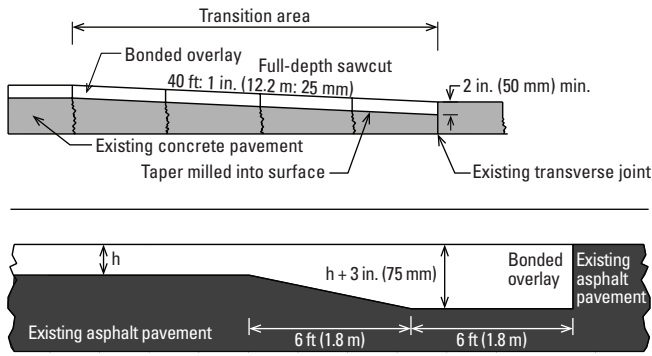

Recreated from Snyder & Associates, Inc., used with permission

Figure 7.10. Mill and fill profile transitions for bonded concrete overlays on end transition

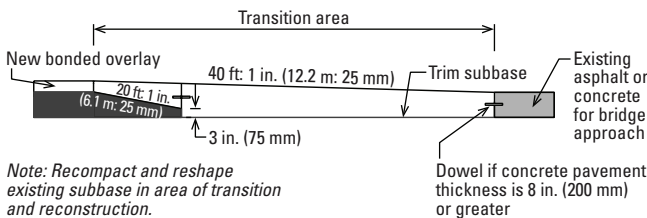

Note: Recompact and reshape existing subbase in area of transition and reconstruction.

Recreated from Snyder & Associates, Inc., used with permission

Figure 7.11. Transition for a COA-B overlay

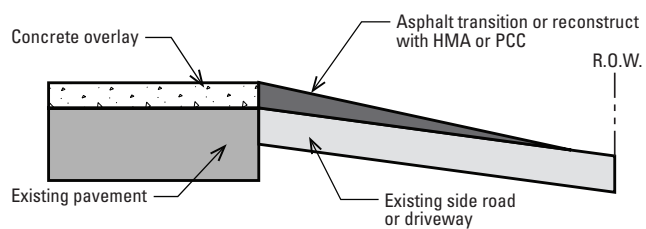
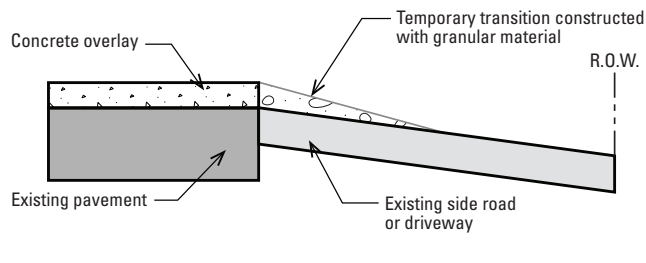

Recreated from Snyder & Associates, Inc., used with permission

Figure 7.12. Temporary transitions

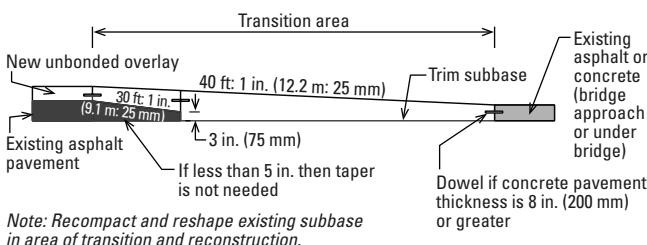

Note: Recompact and reshape existing subbase in area of transition and reconstruction.

Recreated from Snyder & Associates, Inc., used with permission

Figure 7.13. Transition for a COA-U overlay

Details for Overlays in Urban Areas

The following details may be provided with the construction drawings when overlays are placed in urban areas.

Curb and Gutter Details

In areas with curb and gutter sections, special details are needed to illustrate the conditions at the edges of the overlay. Options for addressing curb and gutter sections include the following:

1. Mill the existing pavement gutter. This option provides for a transition area to ensure that the thickness of the overlay is uniform and that the same gutter and curb elevation is maintained.
2. Remove the existing curb. This option involves grinding or sawing the curb section and raising the profile and the elevation of the top of the curb.
3. Overlay the existing curb. This option requires the least amount of effort but results in the greatest increase in profile elevation at the top of the curb.

Figure 7.14 shows example curb and gutter details for these three options, with full-size versions available on [Sheet B.5](#) in the typical concrete overlay construction plans published by the CP Tech Center.

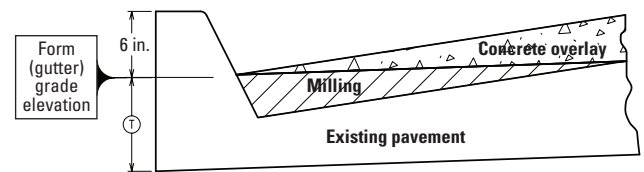

Milling detail when leaving existing curb in place

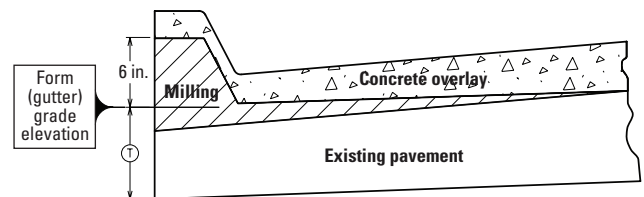

Milling detail when removing and replacing curb

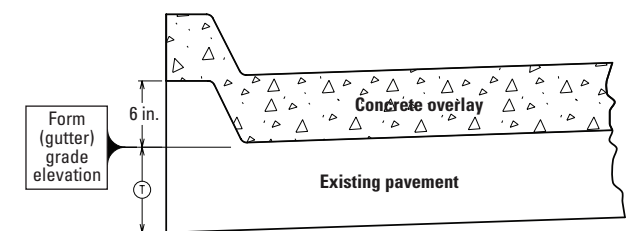

Detail of curb overlay

Recreated from Snyder & Associates, Inc., used with permission

Figure 7.14. Three options for curb and gutter details

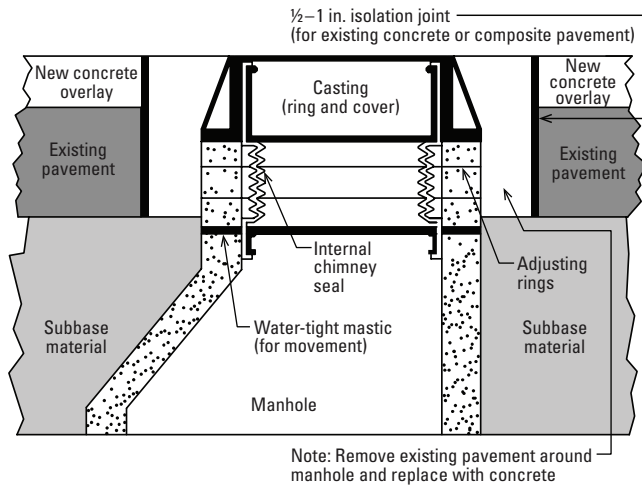

Recreated from Snyder & Associates, Inc., used with permission

Figure 7.15. Utility access detail

Utility Access Details

For concrete overlays in areas that include utility structures, it is important that proper separation is provided between the structures and the concrete overlay. Figure 7.15 shows an example utility access detail illustrating the location of isolation joints around a structure, with a full-size version available on [Sheet B.5](#) in the typical concrete overlay construction plans published by the CP Tech Center.

Miscellaneous Details

The following details may be required when an overlay includes a safety edge or involves a change in superelevation.

Safety Edge Detail

The safety edge is a beveled pavement edge that helps lessen the severity of roadway departures. The typical beveled angle is 30°. A safety edge detail (Figure 7.16) may be necessary when the overlay is opened to traffic prior to completion of the adjacent overlay lane (when constructing under traffic) or prior to completion of the shoulder. Additionally, some agencies require a permanent safety edge at the concrete shoulder.

Superelevation Details

In concrete overlays placed on roadways that require new areas of superelevation or increased superelevation, special details should be considered to show the depth of material needed to meet the final profile (Snyder 2011). In areas of thickened pavement, the following should be considered:

1. The sawcut depths must be adjusted for the contraction joints within the thicker pavement areas.
2. Dowel bars should be placed so that a minimum concrete cover of 2 in. is maintained around the dowel bar.

Figure 7.17 shows an example superelevation detail.

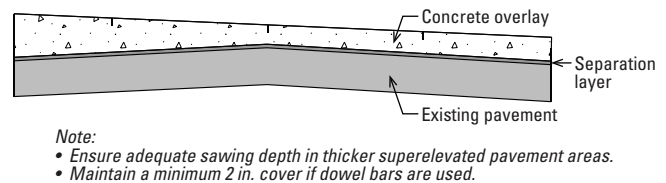

Recreated from Snyder & Associates, Inc., used with permission

Figure 7.17. Superelevation detail

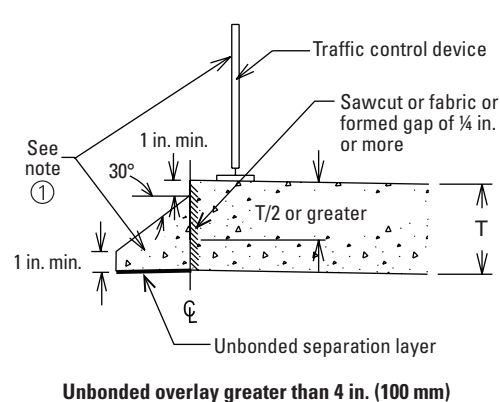
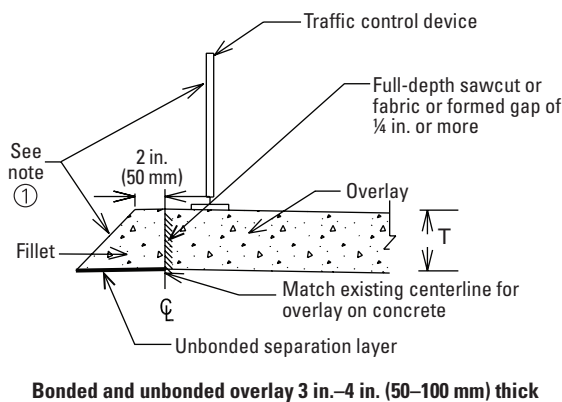

① Traffic control and slope of fillet depends on jurisdictional requirements.

Recreated from Snyder & Associates, Inc., used with permission

Figure 7.16. Safety edge detail

Special Considerations for Continuously Reinforced Concrete Pavement Overlays

Additional considerations are needed when developing construction drawings for CRCP overlays. Refer to [Appendix B](#) for information on the features of CRCP overlays.

For unbonded CRCP overlays specifically, the following should be considered:

- An unbonded CRCP overlay requires the application of a separation layer similar to that used for a conventional COC–U overlay.
- The overlay requires a variable amount of reinforcing steel, approximately 0.7%.
- The thickness of the overlay is determined based on the structural design process.

Additional information on CRCPs in general can be found in the *Continuously Reinforced Concrete Pavement Manual* (Roesler et al. 2016).

Construction Specifications

Like construction drawings for concrete overlays, specifications for concrete overlays do not need to be overly complex. In many agencies, specifications for conventional concrete are referenced for concrete overlay projects.

Guide Specifications for Concrete Overlays (Fick and Harrington 2016) provides guidance for developing technical specifications for concrete overlays.

Recognizing that standard specifications vary widely across the US in terms of style, order of items, and other features, the guidance provided in this document is advisory in nature and is not necessarily suitable for use as specification language. Users should modify the guidance as needed for their standard specifications while preserving the intent of the recommendations provided.

The guide specifications are arranged in a three-part format:

1. **General.** This section describes the types of concrete overlay, types of submittals (including mixture design, materials, and equipment), quality control, scheduling, delivery, measurement, and payment.
2. **Products.** The products section lists materials and concrete mixtures that are allowed in concrete overlays. AASHTO and ASTM references are used where necessary. Most of this section references the contract documents, which include the agency's standard materials used in the concrete mixture design. The section also includes a table on recommended geotextile material requirements.
3. **Execution.** The execution section includes the construction requirements for the project. They include requirements for equipment, pavement construction, surface preparation, paving operations, finishing, curing, and jointing.

Chapter 8

Construction of Concrete Overlays

Pre-overlay Repairs	68
Milling (for Existing Asphalt-Surfaced Pavements)	68
Subgrade/Subbase Repairs	69
Repair of Thermal Cracking in Existing Asphalt Pavement	70
Repair of Deteriorated Joints in Existing Concrete Pavement	70
Separation Layer (for Concrete on Concrete–Unbonded Overlays)	70
Asphalt Separation Layer	70
Nonwoven Geotextile Separation Layer	71
Other Considerations for Separation Layers	72
Concrete Overlay Placement	72
Construction Staking and Machine Control	72
Final Surface Preparation	72
Placing Dowel Baskets	73
Concrete Overlay Curing	73
Concrete Overlay Joints	74
Sawing Joints	74
Sealing Joints	75
Opening the Overlay to Traffic	75
Determining Opening Time	75
Minimizing Early Loading Fatigue Damage	75
Repairs of Concrete Overlays	75
Repairs of Unbonded Concrete Overlays 7 in. Thick or Greater	76
Repairs of Bonded or Unbonded Concrete Overlays Less than 6 in. Thick	76
Special Construction Considerations for Concrete on Concrete–Bonded Overlays	77

The total construction time required for a concrete overlay project is significantly shorter than that required for a roadway reconstruction project because limited quantities of earthwork and base materials are needed (or are sometimes not needed at all) and concrete placement normally proceeds at a much faster pace. Additionally, weather has fewer potential impacts on construction schedules. As a result, resurfaced streets and highways can be opened to traffic within a short period of time with adequate planning (e.g., using the maintenance of traffic recommendations outlined in [Appendix D](#)), expedited staging, and efficient operations.

That said, concrete overlays are, for the most part, constructed using conventional equipment and procedures. Numerous resources are available documenting best practices for the construction of portland cement concrete pavements. The CP Tech Center’s IMCP manual (Taylor et al. 2019, see especially [Chapter 8](#)) is the most current and widely recognized. Additional resources on construction practices are available for purchase from the ACPA (*Concrete Pavement Field Reference—Paving* [EB238] [ACPA 2010]) and for free from the FHWA (*Field Reference Manual for Quality Concrete Pavements* [Fick et al. 2012]).

This chapter focuses on guidance and recommendations that are specific to the construction of concrete overlays and that differ from conventional concrete pavement construction.

Pre-overlay Repairs

For unbonded overlays, pre-overlay repairs should be limited to areas of the existing pavement that exhibit structural distresses that might reflect upward and lead to distresses in the overlay. Bonded overlays of existing asphalt and composite pavement may require more extensive pre-overlay repairs to restore the existing pavement to fair or good condition prior to overlay construction. For information on identifying the distresses discussed in this section during the evaluation of the existing pavement, refer to [Chapter 2](#).

Milling (for Existing Asphalt-Surfaced Pavements)

Milling an existing asphalt surface is not mandatory; both unbonded and bonded overlays can be placed on an unmilled surface. There are, however, numerous reasons for milling an existing asphalt surface prior to placing a concrete overlay:

- To remove nonstructural surface distresses such as shallow potholes, block cracking, random cracking, and thermal cracking
- To remove severe rutting (≥ 2 in.) to reduce the volume of concrete required for the overlay (Figure 8.1)
- To remove a stripped asphalt surface and/or intermediate layer to expose structurally sound asphalt (Figure 8.2)
- To increase the existing pavement’s surface texture to enhance the bond between the overlay and the existing asphalt surface (Figure 8.3)
- To remove pavement to minimize changes in the profile grade
- To correct profile and cross-slope variability (often referred to as profile milling) using 3D machine control. When the existing asphalt is thick enough, this is an effective way to control the volume of concrete required to construct a concrete overlay.

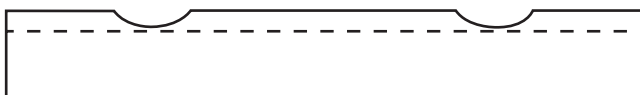

CP Tech Center

Figure 8.1. Milling to remove severe rutting

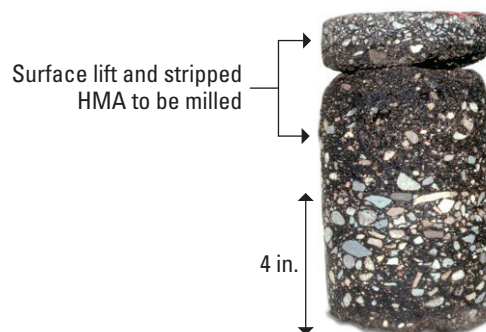

MnDOT, used with permission

Figure 8.2. Core showing pavement that can be milled to remove stripped/unsound material, with 4 in. of HMA remaining in good condition



ACPA, used with permission

Figure 8.3. Asphalt surface milled to enhance bonding with a concrete overlay

Best practices for milling asphalt should be followed. Scabs and loose asphalt should be removed, and the milling depth should be controlled by stringline, ski, or 3D machine control to ensure that at least the planned minimum thickness of asphalt remains after milling.

On occasion, the milling operation may expose the underlying base course or subgrade due to variations in the asphalt's thickness or variations in the milling depth. When this occurs, the common approach is to mill or trim the area around the exposure to an additional depth of 2 to 3 in. and simply increase the thickness of the concrete overlay by the same amount through this section (Figure 8.4). If this approach is taken, the change in concrete pavement thickness must be clearly communicated to the sawing crew so that the sawcut locations and depths can be adjusted accordingly.



CP Tech Center

Figure 8.4. Area where the milling and concrete overlay depths are to be adjusted to address isolated locations where the remaining pavement depth is inadequate

Subgrade/Subbase Repairs

Pavement failures are commonly caused by inadequate support issues and poor drainage. A concrete overlay will not correct any subgrade and drainage issues identified during the evaluation of the existing pavement described in [Chapter 2](#), so these issues must be addressed before overlay placement.

Drainage deficiencies must be resolved at the root cause or they will persist. Undercutting and full-depth patching will not resolve drainage issues. Rather, drainage issues may need to be corrected by regrading ditches, installing underdrain systems, or designing more elaborate solutions.

Failed subgrade and/or subbase areas should be undercut and replaced with suitable material and then capped with a suitable full-depth patch, as described below.

Full-Depth Repairs of Existing Concrete Pavement

Cracked slabs that are not moving (deflecting, rocking, etc.) under traffic need not be removed and replaced. Slabs that are structurally unsound and moving under traffic should be removed and replaced, with subgrade repairs made before replacement. Conventional removal and replacement procedures for concrete pavements can be used, as described in the *Concrete Pavement Preservation Guide* (Smith et al. 2014). The concrete mixture used for the replacement should be designed for a compressive strength of 3,000 psi at 28 days. Load transfer should be designed and tie bars should be installed to match the design of the surrounding existing pavement.

Full-Depth Repairs of Existing Asphalt Pavement

Areas that have failed structurally should be patched by removal and replacement, with subgrade repairs made before the patches are filled.

For unbonded (COA-U) overlays, failed areas can be repaired with new asphalt material (properly compacted to specification) or concrete. If concrete is used, the patched area should be covered with a geotextile fabric to prevent bonding between the overlay and the patch. For bonded (COA-B) overlays, the failed area should be filled with new asphalt material properly compacted to specification and scarified with a mill to enhance bonding.

Full-Depth Repairs of Existing Composite Pavement

Structurally failed pavement should be patched by removal and replacement, with subgrade repairs made before the patch is filled. Normal pavement removal procedures can be used.

For bonded (COA–B) overlays, two strategies can be used:

- Where the dimensions of the failed area are less than 6 ft by 6 ft, the failed area can be repaired with new asphalt material properly compacted to specification and scarified with a mill to enhance bonding.
- For larger areas, a two-layer patch should be placed, with concrete matching the existing lower layer topped by asphalt material properly compacted to specification and scarified with a mill to enhance bonding.

For unbonded (COA–U) overlays, the simplest approach is a full-depth concrete patch with a geotextile layer covering the surface of the patch to prevent bonding.

Repair of Thermal Cracking in Existing Asphalt Pavement

Cracks that are wider than the maximum coarse aggregate size used in the concrete overlay mixture should be filled to prevent the overlay from keying into the underlying pavement. These cracks can be filled with joint filler material, flowable mortar mixture (a combination of portland cement, sand, and water), sand, or fines produced by the milling operation. Narrower cracks do not require treatment.

Repair of Deteriorated Joints in Existing Concrete Pavement

For unbonded (COC–U) overlays, badly deteriorated joints in the existing pavement should be addressed before the separation layer is placed. All loose material in the joints should be removed by a combination of manual methods and compressed air (approximately 150 psi), and the joints should be filled flush with the pavement surface using a flowable mortar mixture (Figure 8.5). Some agencies have also used asphalt milling fines or HMA to fill the joints.



Todd LaTorella, ACPA, MO/KS Chapter, used with permission

Figure 8.5. Deteriorated joints in existing concrete pavement cleaned and filled with flowable mortar

Separation Layer (for Concrete on Concrete–Unbonded Overlays)

If a COC–U is being constructed, an asphalt or geotextile fabric separation layer must be placed before the overlay is placed.

Note that because COA–U overlays are typically designed without a separation layer, as explained in [Chapter 3](#), this discussion of separation layers is only applicable to COC–U overlays.

Asphalt Separation Layer

A dense-graded or drainable asphalt layer can be used as a separation layer, as discussed in [Appendix A](#). Example mixture gradations for drainable asphalt separation layers are referenced in [Chapter 6](#).

Normal procedures and standard specifications for the construction of asphalt pavements are appropriate for placing asphalt separation layers. A key parameter for dense-graded asphalt mixtures is in-place air voids. Areas of low density (with a high amount of in-place air voids) can lead to settlement of the concrete overlay due to secondary consolidation, volume change, and increased risk of stripping. Regardless of the type of asphalt separation layer used, best practices for asphalt mixture design and construction should be followed to provide an adequate foundation for the concrete overlay that resists stripping and delivers long-term support and stability.

Nonwoven Geotextile Separation Layer

The use of nonwoven geotextile separation layers for unbonded overlays has increased greatly over the last several years (see *Performance Assessment of Nonwoven Geotextile Materials Used as Separation Layer for Unbonded Concrete Overlay of Existing Concrete Pavement Applications in the US* [Cackler 2017]). These materials have quickly matured from pilot/research implementations to become the default separation layer for many agencies.

In general, the following construction practices have resulted in successful installations of geotextile separation layers:

- Before placing the geotextile material, the following actions should be taken:
 - Repair the existing pavement to correct any significant cracking and subgrade/subbase failures (identified during the evaluation of the existing pavement described in [Chapter 2](#)). Pre-overlay repairs for unbonded overlays are typically minimal.
 - When faulting greater than 0.25 in. (or an amount specified by the engineer) is present, reduce the amount of faulting by milling.
 - Fill any rumble strips in the existing shoulder or centerline with a low-strength mortar or asphalt patching material.
 - Sweep the pavement surface clean.
 - Schedule placement of the geotextile material so that the paving operation can proceed uninterrupted but not so far ahead of the paving operation that the fabric can become damaged.
 - Unroll the material onto the existing pavement while keeping the geotextile aligned with the pavement edges and taut, avoiding wrinkles or folds.
 - Unroll sections of the material in a sequence that will facilitate proper lapping, prevent folding or tearing by construction traffic, and minimize the potential that the material will be disturbed by the paver.
 - Provide 6 to 10 in. of overlap between sections of the geotextile material and ensure that no more than three layers overlap at any point (Figure 8.6).
- Ensure that the edge of the fabric extends to the foreslopes (when daylighting), terminates in an underdrain trench, or, in the case of pavements with curb and gutter sections, extends into a drainage structure (inlet). (See [Chapter 7](#) for curb and gutter details.)
 - Secure the fabric to the existing pavement using either of the following two options:
 - Use an adhesive similar to 3M Geotextile Seaming Cylinder Spray Adhesive (Figure 8.7).
 - Use pins (nails) punched through 2.0 to 2.75 in. diameter galvanized discs placed 6 ft apart or less, depending on conditions.



ACPA, used with permission

Figure 8.6. Overlapping sections of nonwoven geotextile material



Dan King, Iowa Concrete Paving Association, used with permission

Figure 8.7. Use of adhesive to secure geotextile fabric to an existing pavement

Limit construction traffic on the geotextile to only that necessary to facilitate concrete paving. If construction traffic must be allowed onto the geotextile, the following precautions should be taken to mitigate tears and wrinkles in the fabric:

- Leave temporary gaps in the geotextile where trucks are crossing and making sharp turns.
- Advise construction traffic to avoid sharp turns and heavy braking.
- Remove and replace damaged and torn fabric.
- Reduce the travel speed of construction traffic.

Other Considerations for Separation Layers

When a nominal thickness of asphalt or geotextile is specified, the separation layer essentially mirrors the profile of the existing pavement. While some bumps and dips will be smoothed out by an asphalt layer, the majority of the existing profile variability will be corrected by the variable depth in the concrete overlay. This approach is common and typically results in the lowest cost to the agency when the concrete overlay is measured and paid for using either a square yard pay item for placement and a cubic yard pay item for materials or a single cubic yard pay item, as noted in [Chapter 7](#).

Concrete Overlay Placement

As stated above, there are few differences between constructing a concrete overlay and constructing a normal concrete pavement. However, these differences can be important. The key construction differences are summarized below.

Construction Staking and Machine Control

The existing pavement on which a concrete overlay is placed often has more profile and cross-slope variation than the prepared subbase on which a new concrete pavement is placed. There are three primary challenges associated with this variability: (1) ensuring that the concrete overlay is constructed to the proper thickness tolerance, (2) achieving a specified smoothness, and (3) minimizing the volume of concrete needed to construct the project.

The means to meet these objectives are in conflict, so the final overlay profile must be optimized to meet all three. A detailed survey of the existing pavement that

accurately models the surface is needed to optimize the design profile grade of the overlay. Conventional surveying methods can be used for this task, provided that a sufficient number of survey lines are collected to capture all slope breaks, areas of rutting, and other pavement characteristics that will affect the optimum profile grade line for the overlay. Newer surveying techniques such as LiDAR scanning and aerial drone surveying are well suited for this application and should provide a more complete data set for use in determining an optimal profile grade line for the overlay.

Once an optimized profile has been developed, accurate machine controls, whether stringline or 3D controls, must be used to achieve the smoothness desired. (For more information on machine control, see the FHWA tech brief *Stringless Paving* [Snyder 2019].) Compared to stringline controls, 3D controls reduce the footprint of the paving operation; the lateral clearances required for stringless paving range from 2 to 3 ft (Figure 8.8) compared to 6 to 10 ft for stringline paving.

Final Surface Preparation

Just ahead of the paving operation, the existing pavement or separation layer should be swept clean. For bonded overlay applications, the sweeping should be followed by a wand blowing oil-free compressed air.

After sweeping, the surface should be kept damp, with any free water removed directly ahead of the paver. When paving on a geotextile separation layer, the objective should be a slightly damp surface. (See [Chapter 6](#) for more information on the appropriate amount of water for geotextile separation layers.) If the geotextile is overwatered, it can become saturated and cause bleed water to rise through the concrete overlay to the surface. This is especially an issue at the bottom of vertical curves; geotextile is a good drainage conduit, and excess water accumulates at low points.



Snyder & Associates, Inc., used with permission

Figure 8.8. Stringless paving, with lateral clearance primarily a function of paver track width

Placing Dowel Baskets

If dowel baskets are included in the overlay design, best construction practices should be followed. (For more information, see the FHWA tech brief *Dowel Basket Anchoring Methods: Best Practices for Jointed Concrete Pavements* [Voigt and Ferrebee 2016].) Anchoring dowel baskets securely to the existing pavement is essential to providing the intended load transfer at the contraction joints. Anchor nails should be placed on the downstream side of the basket wire on both sides of the basket relative to the direction of paving (Figure 8.9).

Movement of dowel baskets has been observed on some concrete overlay projects and has been attributed to several factors:

- Nails may be insufficiently anchored in asphalt separation layers with variable thicknesses. Such asphalt layers require different nail lengths and different shot velocities as the asphalt thickness changes across the paver width. It is recommended that the anchor nails extend through the full depth of the separation layer and embed a minimum of 1 in. into the underlying pavement.
- Geotextile fabric and newly placed, fine-graded asphalt mixtures provide less friction than a milled surface or existing concrete. Reduced friction can cause the dowel baskets to move as the concrete head in front of the paver slides along the surface of the separation layer instead of rolling as the paver moves forward.
- An excessive concrete head can cause the concrete in front of the paver to be pushed rather than rolled, which can move the dowel baskets.

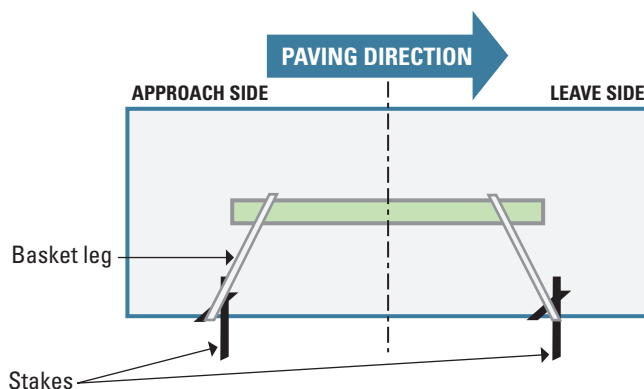

Adapted from ACPA, used with permission

Figure 8.9. Dowel basket anchor nails placed on the downstream side of the basket relative to the direction of paving

Shipping wires should be left intact. This is true even when an MIT-SCAN device is used to verify dowel placement nondestructively. The shipping wire affects the MIT-SCAN output but will not render it unusable for determining dowel locations. For information on the use of the MIT-SCAN device, see *Colorado Procedure (CP) 79-20, Standard Practice for Evaluating MIT-SCAN Images for Uncut Dowel Baskets* [CDOT 2021].

Periodically, dowel placement should be manually verified after the paver has passed over the baskets (Figure 8.10). Suspend paving operations if the baskets are found to be moving until a plan for securely anchoring the baskets is approved. Numerous methods are available for checking the placement of dowels once the concrete has hardened, such as MIT-SCAN, MIT-SCAN-T2, ground penetrating radar, and coring. Although the precision of these methods varies, it is recommended that dowel placement be verified through some means.

Concrete Overlay Curing

While curing is critical (yet often overlooked) for all concrete pavements, it requires particular attention for overlays less than 8 in. thick. (For more information on curing, see the *IMCP manual* [Taylor et al. 2019] and *Curing Concrete* [Taylor 2013].) Because the ratio of surface area to volume is greater for thinner overlays than for typical concrete pavements, the same rate of evaporation will have greater detrimental effects on thinner overlays that are not properly cured. For example, excessive drying shrinkage caused by late and/or inadequate curing can reduce bond strengths due to moisture-related warping within the concrete overlay.



Kevin W. McMullen, Wisconsin Concrete Pavement Association, used with permission

Figure 8.10. Manual verification of dowel placement

Three primary issues impact the curing of concrete overlays:

1. **Timing.** The curing compound must be applied before any surface evaporation occurs.
2. **Materials.** A good-quality curing compound should be used (see [Chapter 6](#)); some state DOTs have had success with alpha-methylstyrene curing compounds.
3. **Coverage.** It is critical that the overlay concrete, including both the surface and sides, is completely covered with curing compound. Streaking and gaps in coverage should not be visible; rather, the cured surface should have an appearance similar to a white sheet of paper. To achieve complete coverage, it is essential that the nozzles used to apply the curing compound are clean. Daily cleaning of the nozzles is recommended.

A typical coverage rate of curing compound for thinner overlays (less than 7 in. thick) is 150 ft²/gal, applied in two coats. Heavier coverage of curing compound can cause difficulty in sawing on steep hills, especially when lighter early-entry saws are used, because the saws may tend to slip on the curing compound.

Evaporation retardant should be on hand and available for use as emergency protection when the curing operation is delayed. Evaporation retardant should not be used as a finishing aid but rather should be applied only when necessary after all finishing operations have been completed.

Concrete Overlay Joints

Sawing Joints

Thinner overlays with smaller slab dimensions require both earlier sawing and a sufficient number of saws to ensure that joints are sawed before random cracking occurs. Concrete overlay placement rates can be restricted by the number of saws available, but proper planning can ensure that production is not hindered by joint sawing operations (Figure 8.11).

Several factors contribute to the need for earlier sawing and an increased number of saws in thinner overlays:

- Stiffer underlying layers increase the internal stresses in the early-age concrete.

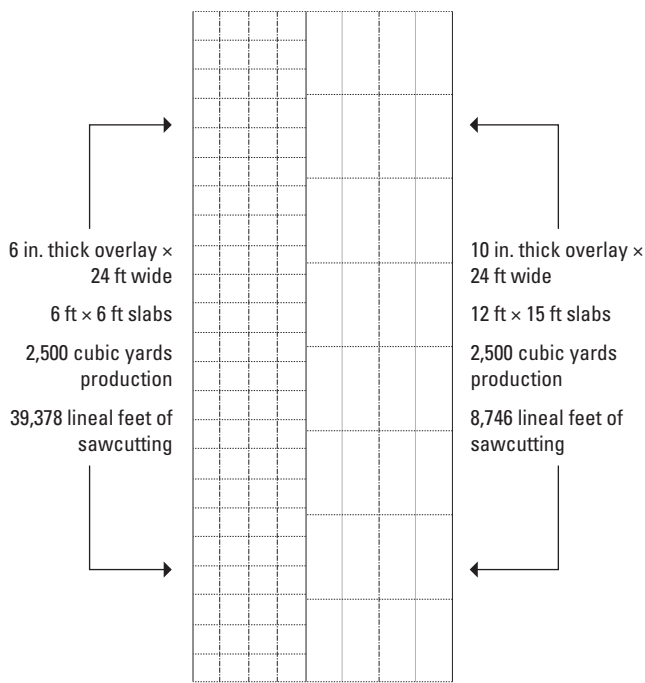

CP Tech Center

Figure 8.11. Comparison of sawcutting needed for overlays of different thicknesses and slab sizes

- Thinner overlay sections have a higher ratio of surface area to volume. This can lead to faster strength gain due to solar radiation and can make the overlay sections more sensitive to drops in ambient temperature, which can increase the risk of random cracking unless the joint sawing operation is timely.
- Differential temperature and moisture values throughout the thickness of the slab can cause early-age curling and warping. Under certain conditions, these stresses are additive and may result in cracking. While moisture-related warping stresses can be mitigated through proper curing, large variations in ambient temperature and relative humidity at the time of overlay placement can contribute to the stresses in the overlay. Appropriate adjustments to the mixture design and paving operation, as described in [Chapter 6 of the IMCP manual](#) (Taylor et al. 2019), should be made to address these conditions, or, when feasible, overlay placement should be scheduled around these conditions.

Sawcut depths should be closely monitored in the field to ensure that they meet the specified minimum depth. Additionally, because cracking typically initiates at the slab edge, the proper sawcut depth should extend through the edge of the pavement. Where variable-depth pavement is placed to adjust the cross slope, the sawcut depths must be adjusted to create a proper weakened plane that will promote controlled cracking. (For more information on joint sawing, see [Appendix A](#).)

[HIPERPAV](#) (The Transtec Group 2021), a software tool that predicts stresses in concrete, is especially useful for quantifying the risk of early-age cracking and planning the sawing capacity needed for a project. HIPERPAV is a proven tool for both standard concrete pavement and concrete overlay construction.

Sealing Joints

Design considerations for determining the need to seal joints in a concrete overlay include, but are not limited to, type of overlay and climate (refer to [Appendix A](#)). The process for sealing joints is the same for both concrete overlays and normal concrete pavements. Best practices for sealing joints are fully described in [Chapter 8 of the IMCP Manual](#) (Taylor et al. 2019) and are summarized in the ACPA tech brief [Concrete Pavement Joint Sealing/Filling](#) (ACPA 2018).

Opening the Overlay to Traffic

Determining Opening Time

In most cases, the state or local agency's standard specifications for opening to traffic can be used to determine when to open an overlay to traffic. When accelerated opening to construction and/or public traffic is desired, a project-specific minimum opening strength can be calculated based on the guidance provided in [Concrete Strength Required to Open to Traffic](#) (Freeseaman et al. 2016). Maturity testing can also be used in conjunction with this approach, as demonstrated in the ongoing project [Evaluation of Long-Term Impacts of Early Opening of Concrete Pavements at MnROAD](#).

Minimizing Early Loading Fatigue Damage

The fatigue life of a concrete pavement is sensitive to early traffic loading. Decreases in fatigue life caused by the early application of heavy loadings (before the concrete has reached the specified strength) can be avoided by keeping wheel loads 1 to 2 ft from the free edges of the pavement. Structural analyses show that high levels of pavement support also reduce early-age load-related stress. With concrete overlays, the underlying pavement provides a higher level of support than is present in most conventional paving.

Repairs of Concrete Overlays

Concrete overlays can be expected to provide excellent performance and long life, as documented in the tech summary [History of Concrete Overlays in the United States](#) (Gross, forthcoming). Like all pavement systems, however, some repairs may be necessary during an overlay's service life. For example, some isolated distresses may occur due to subsurface conditions that were not discovered during the design and construction phases or due to deficient materials and construction practices. Regardless of the causes, overlay repairs are relatively straightforward and, in many cases, easier to perform than repairs of conventional concrete pavements.

Two primary resources provide detailed information on the maintenance and repair of concrete overlays:

- [Guide for Concrete Pavement Distress Assessments and Solutions: Identification, Causes, Prevention, and Repair](#) (Harrington et al. 2018); see especially Chapters [15](#), [17](#), and [18](#)
- [Concrete Pavement Preservation Guide](#) (Smith et al. 2014)

Repairs of Unbonded Concrete Overlays 7 in. Thick or Greater

The standard repair procedures used for conventional concrete pavements also apply to unbonded overlays that are greater than or equal to 7 in. thick. The following chapters in the *Concrete Pavement Preservation Guide* (Smith et al. 2014) provide comprehensive guidance on performing several common repairs:

- [Chapter 5. Partial-Depth Repairs](#)
- [Chapter 6. Full-Depth Repairs](#)
- [Chapter 8. Dowel Bar Retrofit, Cross Stitching, and Slot Stitching](#)
- [Chapter 9. Diamond Grinding and Grooving](#)
- [Chapter 10. Joint Resealing and Crack Sealing](#)

Many agencies also have standard specifications and plan details for these repair items.

Repairs of Bonded or Unbonded Concrete Overlays Less than 6 in. Thick

Full-depth, rather than partial-depth, panel replacement is typical for bonded and thin unbonded overlays because the panels are small and relatively thin. After full-depth sawing around the perimeter of the deficient panel, the panel can be removed easily by jackhammers or a backhoe (Figure 8.12).

When the overlay has been removed, the existing base should be examined. If the underlying pavement is determined to be deficient, it should be removed and replaced with concrete. In such cases, it is most common to place the patch as one monolithic slab instead of two lifts.



ACPA, used with permission

Figure 8.12. Removal of overlay panels

Replacement overlay panels are easily constructed, finished, and cured using typical overlay procedures and materials (Figure 8.13).

Other common repair methods for thinner overlays include diamond grinding and grooving and joint resealing and crack sealing.

Thin concrete overlays at the end of their service life can be milled and replaced easily (Figures 8.14 and 8.15). Removal by milling (also referred to as carbide milling, cold planing, or roto-milling) is a good option for concrete overlays that do not contain load transfer dowels or excessive steel reinforcement.



Dan DeGraaf, Michigan Concrete Association, used with permission

Figure 8.13. Finishing and curing of a concrete overlay repair



ACPA, used with permission

Figure 8.14. Typical concrete pavement milling operation in progress



Dan DeGraaf, Michigan Concrete Association, used with permission

Figure 8.15. Results of a typical concrete pavement milling operation

Milling a concrete overlay is similar to milling an asphalt layer in the following ways:

- The milling depth can be feathered into adjacent pavements.
- Milling can be completed on specific selected sections.
- The coarseness of the surface after milling and the fineness of the millings can vary based on the type and spacing of the teeth on the milling drum.

The productivity of concrete milling depends on the hardness of the aggregate in the concrete, the bit configuration of the milling machine, and the removal depth. For example, it has been observed that a 2 in. deep concrete overlay can be removed at approximately 8,000 ft²/hour and a 4 in. deep overlay can be removed at approximately 2,700 ft²/hour.

Special Construction Considerations for Concrete on Concrete–Bonded Overlays

COC–B overlays are applicable in very limited circumstances. Design and construction guidance for COC–B overlays can be found in [Appendix C](#).

Appendix A

Fundamentals of Concrete Overlay Design

Overview of Concrete Overlay Design	80
Concrete Overlay Thickness Design	80
Typical Thickness Design Inputs and Considerations	80
Selection of a Thickness Design Procedure	80
Overview of Common Concrete Overlay Design Procedures	82
Key Design Considerations	84
Design Considerations for All Concrete Overlays	85
Design Considerations for Concrete on Concrete–Unbonded Overlays	85
Design Considerations for Concrete on Asphalt–Unbonded Overlays	89
Design Considerations for Concrete on Asphalt–Bonded Overlays	90
Design Considerations for Concrete on Concrete–Bonded Overlays	93
Additional Design Considerations to Address Impacts of Profile and Grade Changes	95
Overhead Clearance	96
Shoulder Considerations	96
Barriers and Rails	96
Foreslopes, Backslopes, and Across-Road Drainage Structures	96
Safety Edge	96
Widening and Lane Additions	97
In-Place Structures	98
Curb and Gutter Details	98
Transitions	98

Overview of Concrete Overlay Design

Concrete overlay design procedures generally consider user inputs such as anticipated traffic, climate, support layers, material properties, slab geometry, and performance criteria to develop a recommended overlay thickness. The designed overlay thickness is a major driver of overlay cost and is, therefore, a major factor in whether a concrete overlay is selected for a given project.

Moving beyond thickness design, however, the comprehensive design of concrete overlay systems includes many additional components:

- Determination of the type and extent of pre-overlay repairs
- Selection of construction materials with the appropriate properties
- Assumption of bonding or restraint at the interface between the overlay and the existing pavement (i.e., whether the overlay is bonded or unbonded)
- Design of edge support (e.g., for widened lanes or tied concrete shoulders), if any is needed
- Determination of overlay panel dimensions and joint layout
- Selection of joint design details (e.g., load transfer and sealant provisions), if any special considerations are required

Some of these components, such as joint layout and construction material properties, can significantly impact overlay performance. Other inputs, such as panel dimensions, joint details, edge support, and bond condition, directly impact thickness design and therefore must be selected concurrently with, and as a part of, the thickness design. The goal of a successful concrete overlay design should be to address all design components of the overlay system in a manner that balances cost with desired performance in terms of quality and duration of service life.

Concrete Overlay Thickness Design

Designing a concrete overlay is a process that begins with characterizing the existing pavement (as outlined in [Chapter 2](#) of this guide), defining critical design variables, and then calculating the required overlay thickness.

In selecting the final thickness design, it is important for the engineer to anticipate what the condition of the existing section will be at the time of actual construction of the new concrete surface. If construction will not begin for two or three years, some degradation of the existing structure should be anticipated and considered in the analysis.

Typical Thickness Design Inputs and Considerations

The numbers and types of inputs to be considered during overlay thickness design vary greatly. The following checklist includes many of the unique factors and design inputs that should be considered in overlay thickness design:

- Extent of pre-overlay repairs needed
- Need for reflective crack control
- Overlay panel size
- Presence of reinforcement in the overlay slab
- Assumed bond or separation between the overlay and the existing pavement
- Separation layer characteristics (if a separation layer is used)

Selection of a Thickness Design Procedure

Several procedures are available for designing various types of concrete overlays. Two major factors in selecting a thickness design procedure include the basis for the design (i.e., empirical versus mechanistic-empirical) and the assumption of a bond (or lack thereof) at the interface between the overlay and the existing pavement.

Empirical versus Mechanistic-Empirical Design Procedures

Pavement design procedures rely on models that can generally be classified as either empirical or mechanistic. Empirical design procedures rely primarily on empirical models, while mechanistic-empirical design procedures contain elements of both types of models.

Empirical models are based on observations of past behavior and performance. The best-known empirical pavement design models are those used in the design procedures published between 1960 and 1993 by the American Association of State Highway Officials (AASHTO) and the American Association of State Highway and Transportation Officials (AASHTO).

These models predict future pavement serviceability (ride quality) as a function of pavement structure and cumulative applied loads based on design and performance data collected during the AASHO Road Test in the late 1950s.

Mechanistic models use principles of structural and material mechanics to predict the responses (i.e., stresses, strains, deflections, and so on) of a characterized pavement structure (i.e., with known layer thicknesses and material properties) to applied loads and climate conditions. Finite element analysis (FEA) software (or a neural network based on the results of hundreds or thousands of FEA software runs) is usually used in the mechanistic modeling of concrete pavements.

Designing for Bonded versus Unbonded Interface Conditions

The degree of bonding, mechanical interlock, or frictional resistance (hereafter simply referred to as “bond”) between a concrete overlay and the structural layer immediately below plays a major role in the behavior of and stress distribution through all layers in the overlaid pavement system.

When the overlay and existing pavement layers are bonded, they act together as a single layer with an effective thickness greater than that of either the overlay or the existing pavement. The combined system has a single neutral axis with respect to bending, and as a result the peak flexural stresses in a bonded overlay are lower than those in an unbonded overlay (Figure A.1, left). Bonded overlays also reduce pavement deflections to a greater extent than unbonded overlays because of the greater stiffness provided by the combined system comprised of the bonded overlay and the existing pavement.

When no bond exists between the overlay and existing pavement layers, the two layers bend separately, with each layer having its own neutral axis and each layer experiencing both tension and compression (Figure A.1, right). The magnitude of flexural stresses in each layer depends on the relative stiffnesses of the layers, which depend on the combined effects of the thickness and elastic modulus of each layer.

For design purposes, the overlay’s bond with (or separation from) the existing pavement is an assumed condition that must be selected carefully to avoid premature overlay distress. While some degree of bonding is always present between an overlay and an existing pavement, the degree of bonding that develops depends on the efforts made to bond or separate the two layers.

For example, if an overlay is designed as bonded but adequate adhesive bonding or mechanical interlock is not achieved during construction, the tensile stresses in the overlay will likely be much higher than assumed in design, and premature panel cracking is likely. Conversely, the design of an unbonded overlay assumes no adhesive bond between the overlay and existing pavement layers, and if any bond forms, an improvement in performance may be realized over design expectations. However, if a high degree of bonding is incidentally developed during construction, cracks and other distresses in the existing pavement may quickly reflect through the overlay. Such problems are most likely to occur with relatively thin unbonded overlays of distressed existing concrete or thick asphalt pavement, but this scenario illustrates the need to carry bond-related design assumptions through the construction process.

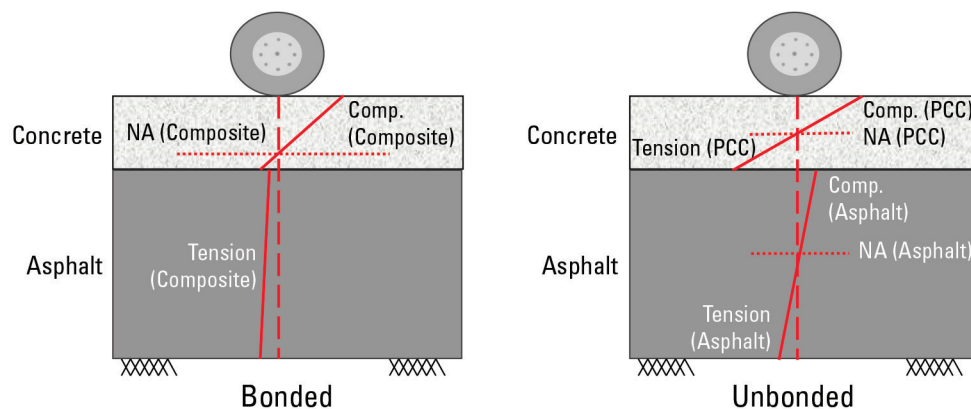

The structural impact of the overlay bond depends on the quality and integrity of both the overlay and the existing pavement, as well as the thickness of the existing pavement. A bonded overlay should not be selected unless the existing pavement (or the portion of that pavement that will remain) is of sufficiently high quality and adequate thickness.

For example, 3 in. (nominal thickness) of sound asphalt pavement is usually considered the minimum acceptable thickness for constructing a concrete on asphalt–bonded (COA–B) overlay. The primary reason for this minimum thickness is that asphalt has a much lower modulus (around 400,000 psi) than portland cement concrete (around 4,000,000 psi), so there is little structural value to be gained by bonding to less than 3 in. of material. When the existing asphalt pavement is this thin, it is often better to design the concrete layer as a new pavement on an asphalt base rather than as a COA–B overlay; in such cases, the thickness of the concrete layer will be slightly greater than that of the concrete layer for a COA–B overlay. In addition, a minimum thickness of asphalt is necessary to support construction traffic and paving operations.

In summary, the interface condition between the overlay and the existing pavement is an important consideration during design. Designers must select the design interface condition based, in part, on the thickness and condition of the existing pavement. The decision whether to assume a bonded or unbonded condition has major implications for the selection of an overlay thickness design procedure, the overlay construction techniques used, the development of future distress in the overlay, long-term pavement performance, and the expected service life of the overlay and pavement.

Overview of Common Concrete Overlay Design Procedures

Many procedures (with associated software applications) are available for designing concrete overlays. This section summarizes the design bases, strengths, and limitations of two of the most commonly used procedures in the US and two newer but promising procedures. The following four procedures are discussed:

- AASHTOWare Pavement ME Design
- PavementDesigner.org
- University of Pittsburgh’s BCOA-ME
- University of Pittsburgh’s UNOL Design v1.0

AASHTOWare Pavement ME Design

AASHTOWare Pavement ME Design is a proprietary implementation of AASHTO’s current mechanistic-empirical pavement design procedures and is recognized by the concrete pavement industry as the best tool for highways and other federal and state roadways. It combines a mechanistic approach to pavement structural analysis (using user inputs for loads, climate, and pavement structural data to compute critical pavement stresses, strains, and deflections) with empirical performance models developed from a large database of field measurements gathered from projects all over the United States. This approach allows users to design and evaluate pavement systems comprising new and innovative features and materials with a high degree of confidence. Licensing and fee structure information can be found at <https://me-design.com/MEDesign>.

For concrete overlays, the designs produced by AASHTOWare Pavement ME Design reflect the interactions between pavement geometry (e.g., panel size and thickness, widened lanes), structural considerations (e.g., use of dowels and tie bars, shoulder type, use of steel reinforcement), local climatic factors, and concrete material and support layer properties.

AASHTOWare Pavement ME Design includes design modules for all types of concrete overlays, including a recently added module for designing short-jointed plain concrete pavement (SJPCP) over asphalt pavement (i.e., COA–B) overlays. The SJPCP design module is based on the University of Pittsburgh’s BCOA-ME design procedure and software but varies in many significant ways (Bhattacharya et al. 2017, Alland et al. 2018), including limitations on panel size (4.5 to 8 ft) and thickness (4 to 8 in.).

AASHTOWare Pavement ME Design provides predictions of pavement performance indicators over the design life of a pavement. For jointed concrete overlays (other than SJPCP), the performance indicators are International Roughness Index (IRI), transverse cracking, and mean joint faulting; for SJPCP over asphalt, the performance indicators are IRI and longitudinal cracking; for continuously reinforced concrete pavement (CRCP) overlays, the performance indicators are IRI and punchouts.

The procedure used by AASHTOWare Pavement ME Design is highly sophisticated and includes the potential for users to provide literally hundreds of inputs characterizing traffic loads, materials, and climate, as well as adjustments to calibrate the performance models for local conditions. Users should have a thorough understanding of the pavement design procedure and the sensitivity of the design inputs. Comprehensive guidance for the AASHTOWare Pavement ME Design procedure can be found in *Guide to the Design of Concrete Overlays Using Existing Methodologies* (Torres et al. 2012), although guidance on the recently developed SJPCP design module is not included.

PavementDesigner.org

In 2016, the concrete pavement industry, including the American Concrete Pavement Association (ACPA), the National Ready-Mixed Concrete Association (NRMCA), and the Portland Cement Association (PCA), initiated an effort to consolidate various concrete pavement design tools to reduce confusion about which design approach to use for any given application (Ferrebee et al. 2018). The resulting free, web-based application, PavementDesigner.org, was released in 2018 and serves as the concrete pavement industry's recommended design methodology for all facilities that are not covered by AASHTOWare Pavement ME Design. The web application, along with accompanying resources and support information, can be accessed at <https://www.pavementdesigner.org>.

The overlay design modules in PavementDesigner.org facilitate the design of concrete on concrete-bonded (COC-B), concrete on concrete-unbonded (COC-U), and concrete on asphalt-unbonded (COA-U) overlays. For the design of COA-B overlays, the program directs users to the University of Pittsburgh's BCOA-ME design tool.

University of Pittsburgh's BCOA-ME

In 2013, researchers at the University of Pittsburgh developed a mechanistic-empirical design procedure for COA-B overlays, BCOA-ME, under a Federal Highway Administration (FHWA) pooled fund study. This free, web-based design application is relatively simple but considers the effects of concrete properties (including the use of macrofibers), panel geometry, existing asphalt pavement thickness and condition, climate, and traffic loading over the lifetime of a pavement. BCOA-ME can be accessed at <https://www.engineering.pitt.edu/Vandenbossche/BCOA-ME/>.

BCOA-ME is the only design procedure for COA-B overlays that considers three potential cracking modes: corner cracking (which predominates in panels with dimensions smaller than 4.5 ft), longitudinal cracking (often observed in 6 ft panels), and transverse cracking (most common in full-lane-width panels). The design process also includes a check, based on the work of Vandenbossche and Barman (2010), to determine whether the evaluated design (i.e., concrete thickness, panel size, and reinforcing content) has significant potential to reflect cracks in the existing asphalt pavement through the concrete overlay. This check does not influence the design thickness but indicates whether construction measures should be taken to prevent reflective cracking (e.g., co-locating overlay joints over cracks in the asphalt or performing pre-overlay crack repairs).

Future planned enhancements for BOA-ME include the development and implementation of a predictive model for transverse joint faulting, which would provide a second design criterion (in addition to slab cracking).

University of Pittsburgh's UNOL Design v1.0

Unbonded concrete overlays have been used in the United States since 1916, but the need for more reliable design and construction guidance has become apparent in recent years. For example, innovations in unbonded concrete overlay technology have led to the introduction of new types of separation layers (including nonwoven geotextiles), the use of macrofiber-reinforced concrete, and the use of smaller panel sizes. Such design and construction options are not adequately characterized in some widely used design procedures. These needs drove faculty at the University of Pittsburgh to develop UNOL Design, a standalone mechanistic-empirical design procedure for COC-U overlays, in 2020 under an eight-state pooled-fund study (Khazanovich et al. 2020). This free, web-based design application can be accessed at <https://uboldesign3.azurewebsites.net/>.

UNOL Design is relatively simple but considers several important design factors: truck traffic volume (initial and future growth in the design lane); climate conditions (from a database of weather station information); panel size; dowel size; shoulder type; the thickness, strength, and elastic modulus of the existing concrete; and separation layer type. Overlay performance criteria include faulting and panel cracking.

The structural and performance models in UNOL Design have been calibrated using laboratory and field data. The cracking and faulting models utilize the incremental damage framework in the current AASHTO *Mechanistic-Empirical Pavement Design Guide* (MEPDG) (AASHTO 2020) and are more sophisticated than those used in AASHTOWare Pavement Design ME. For example, the crack prediction model in UNOL Design considers four different mechanisms and modes of cracking (top-down and bottom-up transverse cracking and top-down and bottom-up longitudinal cracking), and the faulting model is based on separation layer erosion rather than subgrade erosion. The performance models were calibrated using data from the Long-Term Pavement Performance (LTPP) program, the Minnesota Department of Transportation (MnDOT) MnROAD test track, and several Michigan Department of Transportation (MDOT) pavement sections.

UNOL Design can handle concrete overlays with panel dimensions of either 6 ft by 6 ft or lane-width overlays with panel lengths of 12 to 16 ft and a thickness of

4 to 12 in. The software can perform two types of analyses: performance prediction and reliability. If the performance prediction option is selected, the program predicts the percentage of cracked slabs and mean joint faulting at the end of the design life for a given overlay thickness. If the reliability analysis option is selected, the program finds the overlay thickness that meets specified cracking and reliability criteria and predicts joint faulting for the specified faulting reliability level.

Key Design Considerations

Key design considerations for concrete overlays include general considerations for all types of overlays and considerations specific to the various overlay types.

Table A.1 presents a summary of key design parameters for various types of concrete overlays. Parameters that vary by overlay type include typical expected service life, existing pavement condition requirements, slab thickness, panel dimensions, use of dowels and tie bars, suitable design procedures, and use of macrofibers.

Table A.1. Summary of key design parameters

Overlay type	Typical expected service life	Typical existing pavement condition	Typical concrete slab thickness	Typical maximum panel dimension	Dowels in transverse joints?	*Tied longitudinal joints?	Recommended design procedures	Macrofibers directly considered in design procedure?
Concrete on Asphalt-Bonded (COA-B) Overlays	Up to 30 years	Fair to Good	4–6 in.	½ lane width, 6 ft length	Yes (for D ≥ 7 in.)	Yes when D > 4 in. Alternative for longitudinal contraction joints is macrofibers (all thicknesses).	AASHTOWare Pavement ME Design SJPCP, BCOA-ME	Yes for BCOA-ME. Modify concrete strength inputs for other procedures.
Concrete on Concrete-Bonded (COC-B) Overlays	Up to 30 years	Fair to Good	2–4 in.	Match existing joints and cracks	Not in overlay	Not in overlay	AASHTOWare Pavement ME Design, PavementDesigner.org	Yes for PavementDesigner.org. Modify concrete strength inputs for other procedures.
Concrete on Asphalt-Unbonded (COA-U) Overlays	Same as New Pavement Design	Deteriorated to Good	6–7 in. for non-Interstate; 8–12 in. for Interstate	1.5 to 2 times slab thickness in inches, 15 ft max	Yes (for D ≥ 7 in.)	Yes	AASHTOWare Pavement ME Design, PavementDesigner.org	Yes for PavementDesigner.org. Modify concrete strength inputs for other procedures.
Concrete on Concrete-Unbonded (COC-U) Overlays	Same as New Pavement Design	Deteriorated to Good	6–7 in. for non-Interstate; 8–12 in. for Interstate	1.5 to 2 times slab thickness in inches, 15 ft max	Yes (for D ≥ 7 in.)	Yes	AASHTOWare Pavement ME Design, UNOL Design	Yes for UNOL Design. Modify concrete strength inputs for other procedures.
Unbonded Short-Jointed Concrete Overlays (COA-U and COC-U Overlays with Small Panel Sizes)	Same as New Pavement Design	Deteriorated to Good	5–7 in.	½ lane width, 6 ft length	No	Yes. Alternative for longitudinal contraction joints is macrofibers.	UNOL Design (only for COC-U) or AASHTOWare Pavement ME Design	Yes

* See the sections on shoulders and widening and lane additions in this appendix for more information on tied longitudinal joints

Design Considerations for All Concrete Overlays

Need for Uniform Support

For concrete overlays, as for concrete pavements in general, uniformity of support is far more important than strength of support. Thickness design can address the presence of a strong or weak foundation but cannot ensure good pavement performance if the foundation includes areas with abrupt changes in support or isolated large areas of stiffer or softer material. These situations can arise in overlay design, for example, when the overlay will increase lane widths by extending over a portion of a weaker shoulder section. Another example is when profile milling of an existing asphalt surface for a COA–B overlay results in localized areas with a very thin or nonexistent asphalt layer. Uniform support must be restored in such cases with pre-overlay repairs such as localized full-depth asphalt pavement repairs or reconstruction and shoulder improvement.

Brand and Roesler (2014) and Roesler et al. (2016) describe procedures for analyzing concrete pavements under various nonuniform support conditions. Additional information on pre-overlay pavement evaluation is presented in [Chapter 2](#) of this guide.

Use of Macrofibers

Macrofibers are frequently used in concrete overlays (especially for overlays 6 in. or less in thickness) to provide improved resistance to cracking, enhance the joint load transfer provided by aggregate interlock, restrain joint openings, and help retain slab fragments in place when cracks do develop. The structural benefits of using fiber-reinforced concrete (FRC) are typically considered in current design procedures by modifying (increasing) the design input value for the unreinforced concrete flexural strength (or modulus of rupture [MOR]), f_r . An effective flexural strength (f_{eff}) is used in lieu of f_r to account for the effects of using macrofibers in the concrete mixture. It is estimated as follows:

$$f_{eff} = MOR + f_{150}$$

where f_{150} is the residual strength of the concrete after cracking. This value can be estimated using the [Residual Strength Estimator](#) tool developed in 2019 by the National Concrete Pavement Technology Center (CP Tech Center 2019). The residual strength value varies with the concrete mixture design used and the fiber type and content but is typically between 100 and 200 psi. Specified values for the residual strength of FRC often vary with traffic composition and volume,

condition of the existing pavement, overlay design life, slab geometry, slab thickness constraints, and required crack width control.

Joint Activation

Joint activation (also called joint deployment) refers to the development of a crack (a working joint) below the sawcut made at a contraction joint. If a crack does not form beneath the sawcut, the joint has not activated or deployed, and the effective panel length is increased from the nominal panel dimension to the distance between the two nearest activated joints.

While construction practices can promote joint activation, some pavement design parameters also drive the activation mechanisms. A recent research project in Iowa (Gross et al. 2019) on concrete overlay performance found that joint spacing was the predominant factor affecting joint activation, with greater joint spacing leading to more rapid and higher rates of activation. Overlay thickness was also a factor, with the joints in thinner overlays activating less reliably than in thicker overlays.

It is likely that the type of separation layer also plays a role in joint activation for COC–U overlays, with the lower frictional resistance of geotextile fabric contributing to lower activation rates than when an asphalt separation layer is used.

Design Considerations for Concrete on Concrete–Unbonded Overlays

Pre-overlay Repairs

Existing concrete pavement provides very strong support to unbonded concrete overlays, and concrete overlays typically “bridge” over existing minor pavement defects such as cracks, spalls, faulting, and joint repairs without experiencing reduced service life. Therefore, it is not usually cost-effective to perform extensive pre-overlay repairs before placing COC–U overlays. However, designers should ensure that the existing pavement provides reasonably uniform support to the overlay layer, with no rocking panels or panel fragments and no large areas of significantly different structural composition, which can result from lane widening and large full-depth asphalt repairs.

When a COC–U overlay is placed over an existing CRCP that has been repaired with full-depth asphalt patches, consideration should be given to replacing the asphalt patches with concrete to minimize the potential for movements in the existing pavement that could produce buckling or compression failures in the overlay.

Panels and panel fragments that appear to be unstable or that experience visible movement under traffic should be replaced with full-depth concrete repairs (including foundation repairs and the use of dowels and tie bars, where necessary) to ensure long-term stability. Similarly, longitudinal cracks adjacent to settled areas should be repaired with appropriate techniques (such as full-depth repairs or cross-stitching and slab stabilization) to provide stable, uniform support for the overlay. In some cases, the overlay thickness and joint pattern can be modified to prevent uncontrolled panel cracking at locations of known change in support (for example, by placing a tied longitudinal joint in the overlay above the longitudinal edge joint in a widening section, as shown in Figure A.2).

Milling or grinding of faulted joints and cracks in the existing pavement should be considered before overlay placement if the joint or crack faulting is such that the selected separation layer will be unable to prevent the overlay from “keying” or locking into the existing pavement at the joints. For geotextile fabric separation layers, consider joint milling/grinding if faulting exceeds ¼ in. For 1 in. asphalt separation layers, consider joint milling/grinding if faulting exceeds ⅜ in. (or increase the separation layer thickness to exceed the maximum faulting by at least ½ in.).

Selection of a Separation Layer

All COC–U overlays must be separated from the existing concrete pavement using a layer of material that serves one or more of the following purposes:

- Isolates the overlay from the existing pavement by preventing adhesive bonding or interlock of the two layers. This helps prevent cracks and joints in the existing pavement from reflecting through the overlay.
- Drains surface water that infiltrates the overlay via a drainable separation layer that forms a conduit, reducing the potential for erosion of the separation layer and concrete at the interface.
- Provides a degree of compliance or cushioning between the two rigid layers, thereby reducing curling/warping stresses in the overlay.

Many types of separation layer material have been used, but experience has led to the current practice of using either a thin layer (1 to 2 in.) of dense-graded or drainable (permeable) asphalt or a nonwoven geotextile fabric.



ACPA, used with permission

Figure A.2. Tie bars anchored to an existing pavement surface across a longitudinal edge joint where a concrete overlay will be used for a widening section

Asphalt Concrete. Asphalt concrete is, historically, the most common separation layer material for COC–U overlays. The asphalt layer must be thick enough to cover all irregularities in the existing pavement (including joint faulting), as described in [Chapter 6](#) of this guide.

Geotextile Fabric. Nonwoven geotextile fabric is an increasingly popular choice for the separation layer material in COC–U overlays because (1) the use of fabric is often less expensive than the construction of an asphalt separation layer, (2) fabric provides very little friction or interlock between the two concrete layers, resulting in highly effective isolation of the overlay from the existing pavement, and (3) the use of fabric often reduces overlay construction time by eliminating the need to schedule a subcontracted activity. Separation layer fabric is typically specified by weight, thickness, and color, as described in [Chapter 6](#) of this guide.

Panel Dimensions and Joint Layout

Excellent guidance concerning joint layout for conventional concrete pavement is provided in [FHWA Technical Advisory T 5040.30](#) (FHWA 2019). The advisory notes that joint spacing requirements “depend on many factors, including slab thickness, concrete characteristics (e.g., moisture and temperature response, strength, and elasticity), foundation support, and environmental conditions” (FHWA 2019). It recommends that the ratio of panel length to width should not exceed 1.5 and notes that maximum panel length practices have converged around a length of 15 ft for unreinforced concrete. Local experience, materials, climate effects, and so on may result in deviations from these recommendations.

The guidance provided in the FHWA technical advisory, though developed for conventional jointed concrete pavements, is consistent with successful common practices that have evolved for jointing COC–U overlays. Thinner COC–U overlays (6 in. thick or less) are typically constructed with nominal 6 ft square panels, while COC–U overlays with a thickness of 8 in. or more are typically constructed with full 12 ft lane widths and panel lengths ranging from 12 to 15 ft. COC–U overlays with intermediate thicknesses (between 6 and 8 in.) can be built conservatively with small panels but may be successfully built with full-lane-width panels in locations with a mild climate and/or low volumes of heavy traffic.

Small panel sizes result in reduced curling/warping stresses and often result in fewer concurrent wheel loads per panel. These stress reductions allow significant overlay thickness reductions, which are considered in UNOL Design but not in PavementDesigner.org or AASHTOWare Pavement ME Design.

Transverse joint locations in COC–U overlays can generally be selected with no effort made to either match or avoid the location of joints in the underlying pavement. An exception to this practice is that overlay joints must match the location and width of any expansion joints in the underlying pavement; failure to do so may result in buckling in the overlay when the underlying expansion joint closes in warm weather.

Longitudinal joints in COC–U overlays are generally located to match lane lines (which may or may not coincide with longitudinal joints in the underlying pavement). An exception may be for widened lanes, where panels are designed to extend some distance beyond the outside lane boundary into the shoulder to reduce load-related edge and corner stresses.

Additional longitudinal joints in COC–U overlays (located away from the lane lines) are often required for thinner overlays and overlays with smaller panels. Care should be taken to avoid placing these joints within wheel paths, where heavy traffic may cause rapid development of cracking and spalling at the interior corners, as shown in Figure A.3 (King and Roesler 2014). For example, 4 ft wide panels have deteriorated more rapidly than 6 ft wide panels of the same thickness under heavy traffic because of longitudinal joint placement.



Armen Amirkhanyan, used with permission

Figure A.3. Concrete overlay on composite pavement photographed in 2012 after 13 years in service, with the overlay exhibiting interior corner deterioration due to longitudinal joints in the wheel paths

Additionally, joint locations should always be adjusted to reflect best practices for jointing around embedded utilities and drainage structures. The ACPA has published two tech briefs on concrete pavement jointing and intersection joint layout (ACPA 2007, ACPA 1992) that provide examples of good jointing practices applicable to both new concrete pavements and concrete overlays.

Transverse Joints: Dowel Bars, Macrofibers, and Sawcuts

Transverse joints for COC–U overlays can be either plain or doweled (or, in the case of continuously reinforced concrete overlays, nonexistent at locations other than construction headers). Undoweled joints are the most common transverse joint type for COC–U overlays with thicknesses of less than 7 in. because thinner overlays may not have sufficient truck traffic to warrant the use of dowels. In addition, it can be difficult to install dowels in thin pavements with little concrete cover, and hard asphalt or concrete support layers can make it difficult to anchor dowel baskets.

The size and placement of dowels in COC–U overlays should be designed using conventional techniques. The dowels should be protected from corrosion and are normally placed at mid-depth except in areas of cross-slope correction, profile correction, and so on where the planned overlay thickness varies. In such cases, dowels may be placed below mid-depth (for basket placements) or above mid-depth (for inserter placements). In all cases, adequate concrete cover over the dowels must be maintained.

Macrofibers have also been shown to maintain acceptable load transfer in concrete overlays without dowels through aggregate interlock, especially in thin (6 in. thick or less), short-panel concrete overlays. Macrofiber reinforcement properties and test methods are discussed in [Chapter 6](#) of this guide.

The sawcut depth of transverse joints in COC–U overlays is typically $T/3$, but the depth may need to be greater (up to $T/2$) to prevent the development of dominant joints when COC–U overlays are constructed on geotextile fabric. This is because fabric is typically very effective at minimizing frictional restraint at the interface between the overlay and the existing pavement, which reduces tensile stresses in the overlay that would otherwise initiate joint activation.

Longitudinal Joints: Tie Bars, Macrofibers, and Sawcuts

Designing COC–U overlays according to the standard tie bar system design used for new pavements may result in over-reinforcing of the joints, failure of the joints to activate (for contraction joints), and development of longitudinal cracking away from the sawed or formed joints. This is especially a risk for thin overlays and overlays constructed over geotextile fabric (because of the low frictional restraint and resulting low tensile forces in the overlay). Tie bar systems for COC–U overlays should be designed (in terms of bar size, spacing, and length) in consideration of pavement thickness, assumed friction or restraint experienced by the overlay due to friction or interlock with the material immediately below (usually a separation layer), climate conditions, panel dimensions, the distance of the joint to the nearest free edge, and other factors.

It can be difficult to insert or embed tie bars in thin COC–U overlays, and the use of tie bars in one-lane-at-a-time construction with active adjacent traffic can also be problematic. Adding macrofibers to the concrete mixture in lieu of using tie bars can alleviate this problem. Macrofiber use has been shown to be an effective alternative to using tie bars in small-panel COC–U overlays by preventing longitudinal contraction joints from opening, minimizing slab migration, and preventing misalignment of adjacent slab panels.

Longitudinal contraction joints are typically formed or cut to a depth of $T/3$. Care must be taken to ensure that any tie bars present are not cut or damaged during joint sawing.

Joint Filling and Sealing

An ACPA tech brief (ACPA 2018) provides recommendations concerning the need for (and potential benefits of) filling and/or sealing concrete pavement joints as a function of traffic, posted speed limit, climate, and panel size. These recommendations are valid for COC–U overlays as well as conventional concrete pavements.

Special Considerations for Continuously Reinforced Concrete Pavement Overlays

Unbonded CRCP overlays on concrete pavement have been (and continue to be) constructed in the United States, with Texas and Illinois having the most experience with this overlay type. Key design considerations for this overlay type are provided below, with more details provided in [Appendix B](#).

Thickness design for unbonded CRCP overlays should be performed using AASHTOWare Pavement ME Design. Asphalt separation layers are typically used to ensure reliable crack spacing development in the overlay. The only overlay joints that are required are transverse construction joints and longitudinal construction and contraction joints; sawcut depths and widths for longitudinal contraction joints in unbonded CRCP overlays are identical to those described previously for COC–U overlays. Sleeper slabs are preferred over lugs and wide-flange beams for terminal joints and transition slabs.

Design Considerations for Concrete on Asphalt–Unbonded Overlays

COA–U overlays include unbonded concrete overlays on both asphalt and composite pavements.

Existing asphalt and composite pavements are typically treated as composite foundations for COA–U overlays, and the overlay thickness is usually designed according to the method used for a new pavement on a very stiff foundation (which for COA–U overlays is the entire structure of the existing pavement). The exception to this is when a composite pavement features a relatively thin (3 in. or less) asphalt surface layer. In this case, the overlay may or may not be designed as a COC–U overlay, with the thin asphalt layer being treated as a separation layer. If the existing asphalt in the composite pavement is unsuitable for use as a separation layer (i.e., if it is unstable, is susceptible to stripping, or exhibits other problems), it must be milled off and a new separation layer placed over the underlying concrete pavement.

Pre-overlay Repairs

COA–U overlays, whether placed on asphalt or composite pavement, rarely involve extensive pre-overlay repair because (1) the overlay usually bridges intact areas of raveling, fatigue cracking, and similar types of existing asphalt or composite pavement distress and (2) the concrete overlay thickness design is unlikely to change much (if at all) as a result of the repairs, so repair of such areas may not be cost-effective. It is only necessary that the existing pavement provide reasonably uniform support to the overlay layer, with no rocking panels or panel fragments and no large areas of significantly different structural composition. Pavement areas that are unstable or experience movement under traffic should be replaced with full-depth asphalt or concrete repairs, including foundation repairs, dowels, and tie bars where necessary, to ensure long-term stability. The existing pavement should be free of features such as wide joints and cracks, unrepaired potholes, and other features that would permit the overlay to interlock or “key” with the pavement.

Even when no pre-overlay repairs are required, it may be desirable to mill the pavement surface to eliminate

deep ruts or unstable asphalt layers or to reduce profile grade changes that lower overpass clearances or create other safety and geometric problems, such as the need to raise guardrails or adjust ditch slopes. The decision to mill the surface should be balanced against the resulting reduction in the existing pavement structure, the impact on the existing pavement’s ability to carry construction traffic, the impact on the overlay thickness design, and the additional cost of the milling operation. These are more a concern for existing asphalt pavements than composite pavements.

Separation Layer Selection Considerations

Separation layer materials are rarely used for COA–U overlays because the existing asphalt surface layer is usually considered sufficiently compliant (and of much lower stiffness than the concrete overlay) to avoid the reflection of any existing pavement distresses into the overlay. An exception is the previously described case where the asphalt layer in an existing composite pavement is not suitable for use as a separation layer due to instability, the potential for stripping, or other issues; in such cases, a new separation layer is needed, and the design and selection considerations are identical to those described above for COC–U overlays.

Panel Dimensions, Joint Layout and Design, and Joint Sealing

Guidance concerning panel dimensions, joint layout and design, and joint sealing for COA–U overlays is essentially identical to the guidance provided previously for COC–U overlays. However, the presence of asphalt surface rutting and the need for changes in pavement cross section (e.g., to increase cross slope, make grade corrections, or change superelevation) can introduce some additional design and specification considerations.

COA–U overlays are often placed on rutted asphalt-surfaced pavement, with the design thickness of the overlay being achieved at the pavement edge, the ridges between the ruts, and/or at the pavement crown. This results in deeper sections of concrete in the rutted wheel paths, a potential benefit because additional concrete thickness (with reduced stress) is present where heavy loads are most frequent.

One common concern, however, is that the variable overlay thickness results in the need for variable-depth sawcuts at transverse joints to prevent uncontrolled cracking. Because pavement cracking and joint activation generally start at the exposed edges of the overlay (where shrinkage is typically greatest) and propagate across the pavement, it is unlikely that uncontrolled cracking will develop in concrete overlays of rutted pavement if the sawcut is $T/3$ at the pavement edge.

However, if the thickness of the overlay section is variable due to a cross-slope correction such that the design thickness is achieved at the pavement crown and the thickness increases toward the pavement edge, the sawcut depth at the edge should be adjusted to compensate for the added section thickness at this location; in such situations, it may be necessary to adjust the sawcut depth with the overlay thickness across the section to avoid cutting or damaging any embedded dowel bars. Alternatively, dowel bars can be placed at a greater depth (while still maintaining at least 2 in. of bottom cover).

A further consideration in developing bid documents for COA-U overlays on rutted asphalt-surfaced pavement is that rut depth can vary greatly along the length of a project. In such cases, concrete overlay volumes will also vary, resulting in potential material quantity overruns and contractor cost uncertainty when bids are developed solely on the basis of total cost per unit area (e.g., dollars per square yard). The potential for inflated bid pricing can be avoided by including provisions in the contract documents to pay for materials (paid in dollars per cubic yard) separately from placement (paid in dollars per square yard). However, this approach can result in all risk for the project falling on the owner if material volume quantities are not accurately estimated and capped. Ultimately, the decision to use one pay item (dollars per square yard only) or two (dollars per square yard and dollars per cubic yard) boils down to an assessment of risk allocation (contractor versus owner) and the likely impact on overall project pricing.

It should be noted that the use of three-dimensional roadway survey data that are collected to inform the development of plans and specifications can also be used to reduce unexpected overruns of concrete quantities, thereby reducing the risk to the owner in the two-bid-item approach. Three-dimensional survey data are becoming more routinely available as contractors adopt the use of stringless paving systems. This topic is discussed further in [Chapter 7](#) of this guide.

Special Considerations for Continuously Reinforced Concrete Pavement Overlays

Several unbonded CRCP overlays on asphalt-surfaced pavement were constructed in the US in the 1960s and 1970s, and performance has been reported to be satisfactory. Few additional unbonded CRCP overlays on asphalt-surfaced pavement have been built in the US in recent decades, except for some thin and ultra-thin CRCP overlays on flexible pavements in transition areas in Texas (Chen et al. 2016). Additional details concerning these overlays are presented in [Appendix B](#) of this guide.

Design Considerations for Concrete on Asphalt-Bonded Overlays

COA-B overlays include bonded concrete overlays on both asphalt and composite pavements.

A COA-B overlay should only be considered for an existing asphalt-surfaced pavement that is in (or can cost-effectively be restored to) good or better structural condition. COA-B overlays are typically thinner than COA-U overlays because of the increased structural capacity afforded by bonding the concrete and asphalt layers.

The following sections provide guidance on the design and specification of COA-B overlays, including foundation characterization, pre-overlay repairs, material selection, achievement and maintenance of a bond, joint layout and design, and more.

Foundation Support Characterization

One challenging aspect of COA-B overlay design is the characterization of the modulus of foundation support, k , for the composite pavement structure. Because the asphalt layer is considered part of the new monolithic pavement structure, the k value should represent the combined effect of all layers immediately below the asphalt. For composite pavements, this would be the effective k value of the materials below the existing asphalt layer. Some procedures for estimating the effective k value have no upper limit, even though differences in k values over 1,000 psi/in. are meaningless in concrete pavement design; therefore, it is recommended that the effective k value of the materials below the asphalt be limited to 1,000 psi/in. This limit would generally be applied whenever a bonded concrete overlay is placed on an existing composite (asphalt-overlaid concrete) pavement.

Pre-overlay Repairs

The existing pavement surface should be in (or be able to be cost-effectively restored to) good or better condition. Loose, raveled, or stripped material should be removed to ensure the presence of a sound asphalt surface (with a minimum remaining thickness of at least 3 in.) to which the concrete overlay can bond. The overlay should be designed for the weakest (in terms of both thickness and strength) asphalt pavement area that will remain after any repairs have been made. Optimal repair quantities can be estimated by considering the trade-off between the additional cost for repairing the next weakest area versus the savings associated with a reduced overlay thickness.

Overlay Material Selection

The selection of concrete overlay materials, including macrofibers, and mixture proportioning are discussed in [Chapter 6](#) of this guide.

Macrofibers should be considered for use in any COA-B overlay less than 6 in. thick. The added cost of macrofibers will be partially offset by a reduction in the required overlay thickness based on the effective strength of the material.

Achievement and Maintenance of a Bond

The development and maintenance of an adequate bond between the concrete overlay and the existing asphalt pavement is critical to the performance of a COA-B overlay. Loss of the bond (or failure to develop an adequate bond) will accelerate the development of pavement distress and reduce the overlay's service life, especially for thinner overlays. Existing design procedures for COA-B overlays do not specifically address the required strength of the overlay bond but rather treat it primarily as a construction issue because bond-related failures rarely occur when proper construction and curing techniques are used. Refer to [Chapter 8](#) for information on proper construction and curing practices.

Maximum Overlay Thickness

The maximum COA-B overlay design thickness using BCOA-ME is 6.5 in. The maximum design thickness using the SJPCP module of AASHTOWare Pavement ME Design is 8 in. At greater overlay thicknesses, the concrete overlay is so stiff (in terms of both elastic modulus and layer thickness) relative to the underlying asphalt that the asphalt contributes very little to the pavement's flexural resistance to loads. In such cases, the system can be designed as an unbonded concrete overlay.

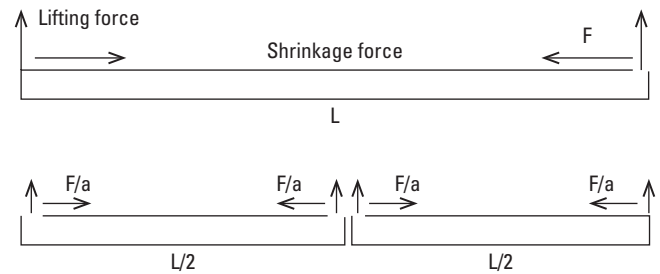

CP Tech Center

Figure A.4. Impact of panel size on thermal and shrinkage restraint stress

Panel Dimensions and Joint Layout

Panel dimensions are a crucial factor in COA-B overlay behavior. When the contact area, pressure, and position of a load are held constant, smaller panels experience smaller bending stresses and can therefore be designed with less thickness. Similarly, thermal and drying shrinkage restraint stresses are reduced with smaller panel dimensions (Figure A.4). For these reasons, panel dimensions are typically selected as a trial design input during the COA-B overlay thickness design process. Because most COA-B overlay thicknesses are 6 in. or less, panel dimensions are almost always 6 ft or less.

Joint locations should always be adjusted to reflect best practices for jointing around embedded utilities and drainage structures. In addition, longitudinal joints in COA-B overlays should be located away from wheel paths because panel corners located within wheel paths often develop load-related cracks and spalls. For this reason, panel widths of 6 ft generally perform better than (and are preferred to) panel widths of 4 ft. Panel aspect ratio (the ratio of the longer side length to the shorter side length) should be approximately 1:1 and should never exceed 1.5:1. The ACPA's tech briefs on concrete pavement jointing and intersection joint layout (ACPA 2007, ACPA 1992) provide examples of good jointing practices that are applicable to both new concrete pavements and COA-B overlays.

As with COA-U overlays, the presence of asphalt surface rutting and the need for changes in pavement cross section (e.g., to increase cross slope, make grade corrections, or change superelevation) can introduce some additional design and specification considerations for COA-B overlays. These considerations involve sawcut depth and construction bid items, specifically the risks and benefits of paying for a COA-B overlay using pay items for both placement (dollars per square yard) and concrete material (dollars per cubic yard).

Dowel Bars, Tie Bars, and Use of Fiber-Reinforced Concrete

Dowels should not be placed in COA-B overlays because (1) COA-B overlays are usually 6.5 in. thick or less, which would result in thin concrete cover, and (2) dowel shear loads would place high tensile stresses on the interface bond, leading to more rapid loss of the bond and failure of the overlay.

Macrofibers have been shown to maintain acceptable load transfer in concrete overlays without dowels through aggregate interlock, especially in thin (6 in. or less), short-panel concrete overlays of all types, as discussed above. Macrofiber reinforcing design is discussed in [Chapter 6](#) of this guide.

The need for tie bars in the longitudinal joints of COA-B overlays depends on the relative stiffnesses of the asphalt and concrete layers, the degree of lateral restraint provided by adjacent lanes and structures (e.g., curb and gutter sections, median islands), and whether macrofibers are used in the overlay concrete mixture. Tie bars should generally be used at longitudinal construction joints, with two No. 4 bars per 6 ft panel often being sufficient.

Experience shows that untied longitudinal joints in COA-B overlays without fiber reinforcement can open over time when the stiffness of the overlay layer is greater than that of the underlying asphalt. In such cases, the longitudinal joints in the overlay may reflect downward through the asphalt, allowing the joint to open significantly and resulting in joint sealant failures and water infiltration.

This phenomenon is shown in Figure A.5, which shows an 8-year-old, 6 in. thick COA-B overlay with 6 ft by 6 ft panels over 6 to 8 in. of asphalt pavement with two 12 in. long No. 4 ties in the construction joint between lanes but no ties in the mid-lane longitudinal joints. The tied joints remained tight, but the mid-lane untied joints opened significantly over several years; the greatest increases in width were in the lane closest to the asphalt shoulder, while the mid-panel joint in the inside lane opened less. The inside lane was adjacent to a concrete median, which prevented lateral lane drift in that direction. It is believed that the joint opening could have been prevented (or greatly reduced) by using tie bars in all longitudinal joints or by using macrofibers in the overlay mixture.

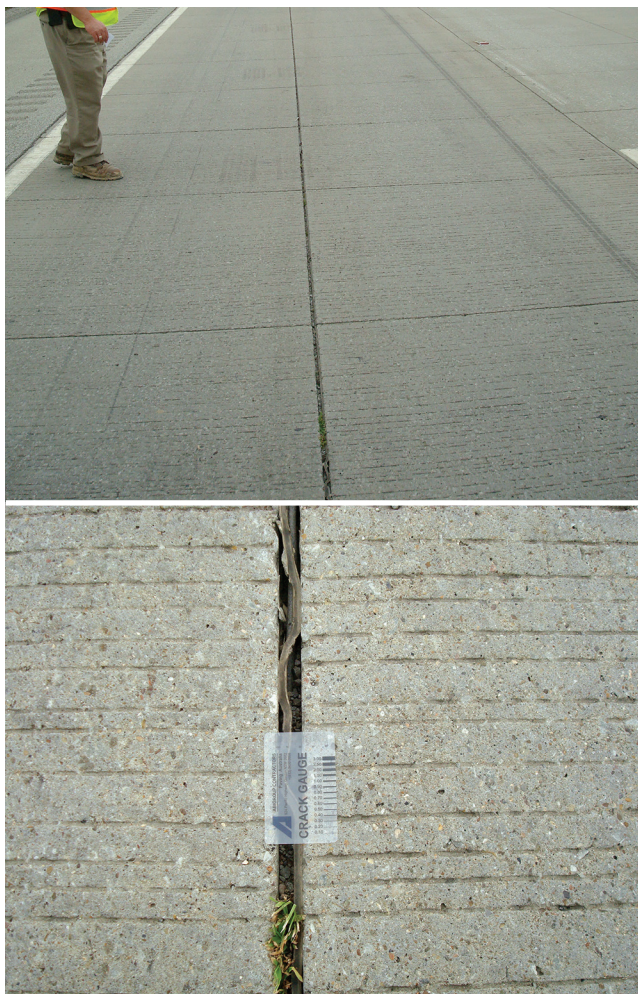

Mark B. Snyder, PERC, used with permission

Figure A.5. COA-B overlay with tied lane joints and untied mid-lane longitudinal joint after eight years of service

When the asphalt layer is significantly stiffer than the concrete layer (e.g., the thickness of the asphalt is more than twice the thickness of the concrete overlay), longitudinal joints in the overlay are less likely to propagate through the asphalt layer and result in longitudinal joint opening. BCOA-ME is the only design procedure that evaluates the relative stiffnesses of the asphalt and concrete layers in different climates to predict the potential for reflective cracking of the concrete layer over cracks in the asphalt. BCOA-ME predicts no potential for reflective cracking in the concrete when the stiffness of the concrete overlay is greater than that of the asphalt, which may be a good indicator of the need for tie bars or FRC mixtures to prevent the longitudinal joints in the overlay from reflecting through the underlying asphalt and allowing pavement migration and joint opening.

The installation of tie bars in the longitudinal joints of COA–B overlays can be problematic, especially for thin COA–B overlay designs. A modified tie bar design featuring two small (No. 3 or No. 4) deformed bars, anchored to the existing pavement surface rather than inserted at mid-depth, has been used successfully to facilitate construction and prevent the longitudinal joints in the overlay from opening. Because the overlay is designed to be fully bonded to the asphalt, there should be no movement of the concrete relative to the asphalt, and the tie bars serve mainly to hold the joints tight and prevent propagation of the joints through the asphalt. Care must be taken to avoid over-reinforcing the joint with too much steel, which may prevent the joint from activating, resulting in longitudinal panel cracking away from the joint.

Reflective Cracking

When the existing asphalt pavement is stiffer than the concrete overlay (in terms of both the elastic modulus and thickness of each layer), especially during cold periods when asphalt stiffness increases and the thermal contraction of both layers is maximized, transverse cracks in the asphalt may reflect through the overlay. This is mainly a potential problem for very thin (2 to 3 in.) overlays over asphalt pavements that are 6 in. thick or more.

BCOA-ME calculates relative layer stiffnesses during design and, when applicable, warns the designer of the increased potential for reflective cracking in the overlay. The designer may be able to decrease reflective cracking potential by increasing the overlay thickness (at an increased cost) or by reducing the asphalt thickness through milling (with a resulting loss of structure). Alternatively, if the cracks in the existing asphalt are reasonably straight, the designer can specify that the overlay jointing pattern be adjusted to position a transverse joint directly over each transverse crack in the underlying asphalt. A third option is to perform pre-overlay full-depth asphalt repairs at transverse crack locations.

Joint Filling and Sealing

Joint filling or sealing is recommended for COA–B overlays, especially in areas with freezing temperatures, to prevent water and ice formation from causing delamination at the overlay-pavement bond interface. Refer to [Chapter 6](#) of this guide for information on joint fillers and sealants.

Special Considerations for Continuously Reinforced Concrete Pavement Overlays

The only evidence of bonded CRCP overlays on asphalt-surfaced pavement in the United States is presented by Chen et al. (2016), who describe some thin and ultra-thin CRCP overlays on flexible pavements in transition areas in Texas. Additional details concerning CRCP overlays are presented in [Appendix B](#) of this guide.

Design Considerations for Concrete on Concrete–Bonded Overlays

While thin COC–B overlays are commonly placed on bridge decks (often using special concrete mixtures to enhance bonding and reduce the potential for shrinkage cracking), they are rarely constructed on existing concrete pavements for the following reasons:

- Successful construction requires that the existing pavement be in good to excellent condition, and such pavements are rarely programmed for rehabilitation or preservation unless major increases in traffic volume or load (beyond the original design levels) are anticipated.
- A good bond between the overlay and the existing pavement can be achieved but requires heightened attention to construction practices, concrete overlay materials, and weather during construction.
- If the bond is lost, even locally at slab corners, cracking is almost certain to develop quickly. Remediation may require expensive, time-consuming full-depth repairs.

Properly designed and constructed COC–B overlays can reasonably be expected to provide a minimum service life of 15 years before maintenance is required. The first indication of problems on these overlay projects is usually early delamination at the bond plane, quickly followed by corner cracking and fatigue failure at isolated joint locations. These distresses can be repaired using partial-depth repair techniques, if the underlying slab remains sound, or with full-depth repairs.

The most common reason for COC–B overlays to develop distress prematurely is that the existing pavement was not a good candidate for this type of overlay or was not properly repaired prior to overlay placement. Trying to place a COC–B overlay on a pavement with significant distress is not recommended.

The following sections provide a summary of design and construction guidance for COC–B overlays. Further information on this type of overlay is provided in [Appendix C](#) of this guide.

Pre-overlay Repairs

The existing pavement surface should be restored to very good condition. All spalls and working cracks in the existing pavement should be repaired before overlay placement. Tight, nonworking cracks can be left unrepaired but can be expected to reflect through the overlay if joints are not placed above them. Alternatively, the use of macrofibers in the overlay mixture or the placement of isolated reinforcing steel can mitigate the development and deterioration of reflective cracking. The overlay thickness design should reflect the structural contribution of the existing pavement after pre-overlay repairs have been completed.

Overlay Materials

The selection of concrete overlay materials and bond enhancement materials (if any are used), along with concrete mixture proportioning, are discussed in [Chapter 6](#) of this guide. For COC–B overlays specifically, minimal overlay shrinkage is desirable, as are thermal expansion characteristics similar to those of the existing pavement. Additionally, the use of macrofibers can help mitigate and slow the deterioration of reflective cracks.

Achievement and Maintenance of a Bond

The development and maintenance of an adequate bond between the overlay and the existing pavement is critical to the performance of COC–B overlays, especially for thin concrete overlays that provide little structure of their own for carrying service loads. Existing design procedures for bonded overlays do not specifically address bond strength but rather treat it primarily as a construction issue because bond-related failures rarely occur when proper construction and curing techniques are used. [Appendix C](#) of this guide presents guidance on surface preparation techniques, including shotblasting and water blasting, that can help the existing pavement

surface achieve a good bond with the overlay. Specified bond strength values typically range from 100 to 200 psi and may vary with the test mode used to determine bond strength (i.e., direct shear or pull-off/tension testing).

Jointing Practices

Joints in COC–B overlays must be cut or formed exactly over the joints in the existing pavement and through the full thickness of the overlay (with sawcut depths often specified as the overlay thickness plus ½ in.) and must be at least as wide as the joint opening below the sawcut or sealant reservoir (Figure A.6). Failure to achieve the proper sawcut width through the full thickness of the overlay will likely result in warm weather closure of the overlay joint before the underlying joint closes, resulting in joint compression and failure of the bond between the overlay and the existing pavement. Failure to closely match joint locations can result in reflective cracks a short distance from the overlay joint locations, with subsequent spalling (Figure A.7).

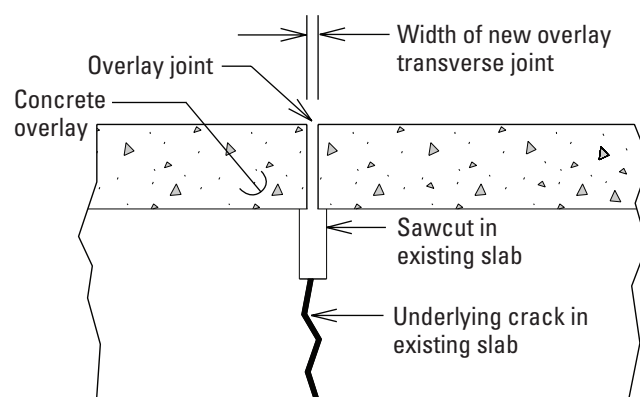

Recreated from Snyder & Associates, Inc., used with permission

Figure A.6. Schematic of a sawcut for a COC–B overlay



Todd LaTorella, ACPA, MO/KS Chapter, used with permission

Figure A.7. Double-crack resulting from failure to match the sawcut with the underlying joint location in a COC–B overlay

Overlay joints cut or formed over nonworking, tied joints need only be cut to one-half the overlay thickness ($T/2$) to ensure crack control. The joint need only be as wide as a single sawcut blade but must be wide enough to allow the joint to be sealed or filled ($3/16$ in. minimum width per ACPA [2018]).

COC–B overlays of long concrete panels, such as those used in jointed reinforced concrete pavement (JRCP), are sometimes placed with additional intermediate joints (Figure A.8) to reduce curling/warping and shrinkage stresses that might lead to loss of bonding. These intermediate joints should also be cut to $T/2$ and sealed or filled with the appropriate materials.



Mark B. Snyder, PERC, used with permission

Figure A.8. COC–B overlay on US 119 in Pennsylvania with 12.3 ft long panels constructed in 2014 on JRCP with 61.5 ft long panels: project overview (top) and exposed longitudinal joint at intermediate transverse joint (bottom)

Dowels and Tie Bars

Dowels are never placed in COC–B overlays because (1) COC–B overlays are usually less than 6 in. thick, which would result in thin concrete cover, and (2) dowel shear loads would place high tensile stresses on the interface bond, leading to more rapid loss of the bond and failure of the overlay. Overlay tie bars are not desirable for the same reason and should not be necessary if the tie bars in the existing pavement are still functioning properly. If a joint needs tie bars (e.g., because the original tie bars have failed or the existing pavement did not have tie bars), they should be retrofitted into the existing pavement using cross-stitching or slot-stitching techniques, as described in the *Concrete Pavement Preservation Guide* (Smith et al. 2014), prior to overlay placement.

Joint Filling

Joint filling is recommended for COC–B overlays, especially in areas with freezing temperatures, to prevent water and ice formation from causing delamination at the overlay-pavement bond interface. Refer to [Chapter 6](#) of this guide for information on joint fillers and sealants.

Special Considerations for Continuously Reinforced Concrete Pavement Overlays

Even less common than jointed COC–B overlays, bonded CRCP overlays on concrete pavement are usually economically viable only when very little pre-overlay repair is required. Most recent overlays of this type were constructed in Texas in the 1980s and have yielded acceptable performance. Additional information on CRCP overlays is provided in [Appendix B](#) of this guide.

Thickness design for bonded CRCP overlays on concrete pavement should be performed using AASHTOWare Pavement ME Design. The only joints that are required in this overlay type are transverse construction joints, matched repair joints, and longitudinal construction and contraction joints; sawcut depths and widths should match those used for conventional COC–B overlays.

Additional Design Considerations to Address Impacts of Profile and Grade Changes

Changes to the pavement profile, cross section (e.g., due to lane widening), and cross slope (e.g., due to improvements to surface drainage and superelevation) that result from an overlay of any type can trigger certain overlay design modifications and roadway design changes.

Overhead Clearance

The presence of overhead structures, power lines, and other features, combined with regulations for minimum overhead clearance, can present challenges that must be addressed in the overlay design. For example, if overhead obstacles cannot be raised to maintain required clearances, limitations on the change in pavement elevation may dictate thinner overlay designs (through stronger materials, smaller panel sizes, or other means), removal of some existing surface material prior to placement of the overlay, or the use of full-depth reconstruction rather than overlays in areas of restricted clearance.

Shoulder Considerations

Lane widenings and lane additions often result in the placement of concrete overlays on at least a portion of the shoulder, which may provide a different level of support than the travel lanes that underlie most of the overlay, especially if the shoulder is unpaved. This difference in support must be properly addressed in design and construction to avoid longitudinal cracking in the overlay over the existing pavement's lane-shoulder joint.

If the shoulder is paved and offers only slightly less support than the existing pavement (e.g., an asphalt-surfaced shoulder adjacent to a concrete pavement), acceptable results can often be achieved by paving the overlay to the desired width and using tie bars embedded above the lane-shoulder joint to hold tight a longitudinal joint sawed at the same location. If the overlay extends no more than 12 to 18 in. beyond the existing lane-shoulder joint, the longitudinal joint and reinforcing can often be eliminated. In all cases, placement of the longitudinal joint within a wheel path should be avoided.

If the shoulder is unpaved and offers a significantly lower level of support than the existing pavement, it is necessary to strengthen or reconstruct at least the portion of the shoulder that will underlie the overlay to approximately match the level of support provided by the existing pavement. The use of a longitudinal sawcut and tie bars over the existing lane-shoulder joint should be considered as well.

Tied concrete shoulders are typically recommended for concrete pavements, including concrete overlays, because they offer edge support, which reduces pavement deflections and improves the long-term performance of the pavement. In addition, the use of tied concrete

shoulders produces a lane-shoulder joint that is easily sealed to prevent water ingress into the pavement structure. However, concrete shoulders should never be used with COA-B overlays because the shoulders' support of the pavement edge can also facilitate loss of the overlay bond. Similarly, concrete shoulders used with COC-B overlays must be tied to the existing pavement and not to the overlay to avoid loss of the overlay bond. Tied shoulders can be used with and are recommended for unbonded concrete overlays on any pavement type, although overlays placed on existing concrete pavements benefit less from the reduction in edge stresses offered by tied shoulders because the existing pavement already provides excellent support for the overlay.

Shoulder improvements of any type should include consideration of cross slopes that are safe for emergency use and provide for rapid removal of surface water.

Barriers and Rails

Safety barriers, guardrails, and cable barriers may need to be raised or reconstructed, depending on the change in profile grade and the horizontal distance between the edge of the pavement and the safety feature.

Foreslopes, Backslopes, and Across-Road Drainage Structures

Overlaying an existing pavement with either asphalt or concrete typically results in changes in the elevation of the pavement edge, unless the existing pavement is milled to allow placement of an inlay that maintains the existing pavement's profile and cross section.

Designers should attempt to address any pavement profile changes in ways that do not impact ditch lines, ditch slopes, drainage structures, and available right-of-way. Such impacts can be minimized (or eliminated) by implementing one or more of the following design options: (1) inlay all or a portion of the new surface layer, (2) maximize the pavement's cross slope within allowable limits, and/or (3) maximize the cross slopes of the pavement and unpaved shoulder within allowable limits.

Safety Edge

The safety edge is a beveled pavement edge designed to facilitate driver recovery of vehicle control when the vehicle leaves the paved portion of the roadway. This feature is most often used on rural two-lane highway pavements with aggregate or earth shoulders. Design details for the safety edge are presented in [Chapter 7](#) of this guide.

Widening and Lane Additions

Concrete overlay projects provide opportunities for widening pavements constructed with narrow traffic lanes. Properly designed and constructed widening sections reduce pavement edge stresses, corner stresses, and deflections, thus reducing panel cracking and joint faulting (i.e., the difference in elevation between the two sides of a joint or crack) while improving long-term ride quality and safety.

Widening a travel surface using a concrete overlay requires an evaluation of any changes in foundation support, appropriate use of reinforcing steel, and proper longitudinal joint placement. This is especially true for widening overlays placed over existing concrete pavements with unbound shoulder materials because of the increased risk of longitudinal cracking along the edge of the existing pavement. (Figure A.9).

Some general recommendations for pavement widening using concrete overlays include the following:

- Keep longitudinal joints out of wheel paths whenever possible, especially for COA–B overlays.
- For unbonded overlays of asphalt or concrete pavement, match the longitudinal joints of the overlay with the longitudinal edge joints of the existing pavement and add tied widening units when possible unless this results in joints within the wheel paths of the overlay.
- When the overlay is placed wider than the existing pavement, avoid locating the edge joints of the overlay more than 12 to 18 in. beyond the existing pavement's lane edges unless the existing shoulder has a structure that provides support similar to that of the existing pavement lane. If this cannot be done, follow the guidance of the previous bullet.
- Tie widening units to either the overlay or to the existing pavement using deformed bars (see the [widening detail](#) in the example construction drawings published by the CP Tech Center).
 - For concrete overlays 5 in. thick or more, locate the tie bars in the overlay at mid-depth. Refer to the discussion on pavement widening details in [Chapter 7](#) of this guide.
 - For concrete overlays less than 5 in. thick, secure the tie bars to the surface of the existing pavement, taking care not to allow traffic to loosen the secured tie bars.



Armen Amirkhaniyan, used with permission (top); Matt Zeller, Concrete Paving Association of Minnesota, used with permission (center and bottom)

Figure A.9. Concrete overlay widening on Illinois Route 53 with no longitudinal joint or reinforcing over existing pavement edge (top); concrete overlay widening on Minnesota TH 212 with longitudinal joints and reinforcing over existing pavement edge in some locations (center) and only reinforcing in other locations (bottom)

Not every detail will apply to every project, but the recommendations listed above can often be applied to address project-specific issues.

Adding new lanes or shoulders can also present issues unique to concrete overlay pavement design, especially if there is variation in the underlying support of the overlay or if the overlay is to be a full-depth concrete pavement. Joint load transfer systems are frequently used in such cases when the overlay system is unbonded. Longitudinal joint tie bars are used to ensure that edge support is provided by aggregate interlock. The design should address differential settlement and water infiltration at these locations.

To prevent cracking related to differential expansion and contraction between a concrete overlay and an adjacent full-depth concrete lane addition, use an isolation joint (i.e., a butt joint with no tie bars) if the overlay is less than 5 in. thick.

In-Place Structures

Existing intakes and utility structures must be raised to match the new pavement elevation. Typical details for adjusting manholes are shown in [Chapter 7](#) of this guide and the [example construction drawings](#) published by the CP Tech Center.

Curb and Gutter Details

Existing curb and gutter sections may pose overlay design challenges related to the maintenance of surface drainage, overlay profile elevation, and so on. Options include (1) leaving the existing curb and gutter system in place while matching the final overlay pavement elevation to the existing system, (2) removing and replacing the existing curb and gutter section, or (3) encasing the existing curb and gutter system within a new system. Refer to the curb and gutter details in [Chapter 7](#) of this guide and the [example construction drawings](#) published by the CP Tech Center.

Factors to be considered in determining how best to treat curb and gutter issues include the condition of the existing curb and gutter section and the proximity of utility poles and other objects to the back of the curb (which could prohibit the use of slipform paving and necessitate the use of hand placement using fixed forms).

The locations of transverse joints in the overlay should be matched with the locations of joints in the curb and gutter section, especially if the curb and gutter section is tied to the overlay. It is also possible to include an integral curb and gutter system during overlay placement, but the potential benefits of this option must be balanced against the cost of constructing the integral curb and gutter system and the availability of the equipment needed for its construction. The selection of standard versus integral curb and gutter design should generally be an option left to the contractor to ensure competitive bidding.

Transitions

Concrete overlay designs usually require details concerning the transition sections linking the concrete overlay with adjacent pavement sections, adjacent structures, and driveway entrances/exits. Transition sections often feature isolated or otherwise unsupported transverse end joints and have the potential to experience impact loading as vehicles cross the end joint. These conditions result in higher stresses in many transition areas, necessitating the use of thicker concrete sections and conventional deformed slab reinforcement, wire mesh reinforcement, and/or macrofibers. Transition lengths are usually based on the design speed for the section. Additional details and examples regarding transition sections are provided in [Chapter 7](#) of this guide.

Appendix B

Continuously Reinforced Concrete Pavement Overlays

Applications and Performance	100
Continuously Reinforced Concrete Pavement Overlays of Asphalt-Surfaced Pavements	101
Continuously Reinforced Concrete Pavement Overlays on Concrete Pavements	102
Evaluation of the Existing Pavement Structure	105
Design	106
Materials and Concrete Mixtures	106
Concrete Mixtures	106
Reinforcing Steel	106
Separation Layer (for Unbonded Overlays)	106
Construction	106
Pre-overlay Repairs	107
Terminal or End Treatment Joints	107
Life-Cycle Cost Analysis of Continuously Reinforced Concrete Pavement Overlays	108
Scenario	108
Principles and Parameters	110
Results	111

Applications and Performance

Continuously reinforced concrete pavement (CRCP) has been in use for at least 60 years as an overlay option on existing asphalt-surfaced and concrete pavements, including jointed plain concrete pavement (JPCP), jointed reinforced concrete pavement (JRCP), and CRCP. Recent examples of CRCP overlays, constructed in 2002 and 2013, are shown in Figure B.1.



Charles Wienrank, used with permission (top); Jeffery Roesler, used with permission (bottom)

Figure B.1. CRCP overlays being placed on I-70 in 2002 (top) and on I-57/I-64 in 2013 (bottom)

The first reported CRCP overlay in the US was constructed in Texas in 1959. Since then, favorable performance has been reported for CRCP overlays constructed in a number of states as well as in the United Kingdom, Belgium, Spain, France, South Korea, and South Africa (see Table B.1). An early report (CRSI 1988) found that at least 600 mi of CRCP overlays had been placed in the US from 1959 to 1980, with thicknesses ranging from 6 to 9 in. Table B.2 summarizes the various states that have designed and constructed CRCP overlays over existing concrete or asphalt pavements.

Relative to JPCP overlays, CRCP overlays provide longer service lives with minimal maintenance (CRSI 1988) and maintain a constant and low International Roughness Index (IRI) value over time. For this reason, roadways with higher traffic volumes, such as an annual average daily truck traffic (AADTT) of 33,000, are ideal candidates for CRCP overlays and are typically where they have been constructed (PCA 1976). The Ben Schoeman Freeway in South Africa, for example, can experience annual average daily traffic (AADT) volumes as high as 150,000 and includes CRCP overlay sections that have demonstrated good performance even after 20 years (Brink and Pickard 2008). CRCP overlays are also an excellent choice for rural principal arterial highways; unbonded CRCP overlays are still being designed and constructed primarily on these roads.

The majority of CRCP overlays have been and continue to be unbonded overlays on existing concrete pavements, with limited applications of bonded CRCP overlays on concrete pavements or CRCP overlays of asphalt-surfaced pavements.

Table B.1. Global experience with CRCP overlays

Countries with CRCP overlays	References
United States (OR, IL, TX, AR, MS, MD, IN, GA, CT, PA, IA, ND, WI, CA)	CRSI 1988, CRSI 1973, CRSI 2003, PCA 1976, Tyner et al. 1981, McNeal 1996, Lippert and DuBose 1988, Lokken 1981, Crawley and Sheffield 1983, Heckel and Wienrank 2018, Choi et al. 2018; personal communication with D. Rufino, J. Moderie, and P. Burch of Caltrans, 2020
United Kingdom	Metcalf and Dudgeon 2004, Gregory 1984, Green and Davies 2000
Belgium	Verhoeven 1989, Debroux and Jasienski 2008, Rens 2005
Spain	Alberola 1997
South Korea	Ryu et al. 2009
South Africa	Brink and Pickard 2008, Kannemeyer et al. 2008, Brink et al. 2006, Strauss et al. 2005
France	Tayabji et al. 1998, FHWA 1993

Table B.2. US experience with CRCP overlays

State	Years of experience	Types of projects	References
Illinois	1967–present	Unbonded CRCP overlays ranging from 6 to 12 in. thick over JRCP and CRCP	CRSI 1988, CRSI 1973, PCA 1976, McNeal 1996, Lippert and DuBose 1988, Heckel 2002, Heckel and Wienrank 2018
Texas	1959–present	Bonded and unbonded CRCP overlays ranging 4 to 7 in. thick over JPCP and CRCP; 8 in. CRCP overlay over asphalt-surfaced pavement	CRSI 1988, CRSI 1973, PCA 1976, Sun et al. 2011, Sriraman and Zollinger 1999, Chen and Hong 2014, Ryu et al. 2013, Delatte Jr. et al. 1998, Kim and Won 2008, Solanki et al. 1987, Chen et al. 2016, Choi et al. 2018
California	2019–present	Unbonded 9 and 10 in. CRCP overlays over JPCP	Personal communication with D. Rufino of Caltrans, 2020
Arkansas	1972–1980	Unbonded 6 in. CRCP overlays over JPCP	CRSI 1988, CRSI 1973, PCA 1976
Georgia	1973–1975	Unbonded CRCP overlays over JPCP	CRSI 1973, PCA 1976, Tyner et al. 1981, CRSI 2003
Oregon	1976–2017	8 to 11 in. CRCP overlay over asphalt-surfaced pavement	CRSI 1988, CRSI 1973, PCA 1976, Sriraman and Zollinger 1999; personal communication with J. Moderie and P. Burch of Caltrans, 2020
Pennsylvania	1974–1976	Unbonded 7 in. CRCP overlays over JPCP	PCA 1976, Sriraman and Zollinger 1999
Wisconsin	1973–1980	Unbonded 7 and 8 in. CRCP overlays over JPCP	PCA 1976, Sriraman and Zollinger 1999
Mississippi	1971–1981	Unbonded 6 in. CRCP overlays over JPCP and CRCP	CRSI 1973, PCA 1976, Crawley and Sheffield 1983, Sriraman and Zollinger 1999
Indiana	1969–1971	Unbonded 6 in. CRCP overlays over JRCP	CRSI 1973, PCA 1976, Sriraman and Zollinger 1999
Iowa	1973	Bonded CRCP overlays	PCA 1976, Sriraman and Zollinger 1999, Betterton et al. 1984
Maryland	1971–1973	Unbonded 6 in. CRCP overlays over JPCP and JRCP	CRSI 1973, PCA 1976
North Dakota	1972–1975	Unbonded 6 in. CRCP overlays over JPCP	PCA 1976
Connecticut	1975–1976	Unbonded 6 in. CRCP overlays over JPCP	PCA 1976

Continuously Reinforced Concrete Pavement Overlays of Asphalt-Surfaced Pavements

A CRCP overlay of an existing asphalt-surfaced pavement can be a viable design alternative, assuming that (1) the existing structure is in adequate condition and will provide a strong, stable base for the overlay and (2) a non-erodible asphalt layer is directly beneath the overlay. CRCP overlays of asphalt-surfaced pavements are less common than other types of CRCP overlays and should be distinguished from unbonded CRCP overlays on existing concrete pavements with an asphalt separation layer.

Some of the first CRCP overlays of asphalt-surfaced pavements were constructed in the late 1960s and early 1970s, with favorable performance being reported after 2 to 6 years in service (Sriraman and Zollinger 1999). The Oregon Department of Transportation (ODOT) constructed four CRCP overlays on asphalt-surfaced pavements on I-5 between 1970 and 1975 (CRSI 1988, Sriraman and Zollinger 1999), which included an 8 in. thick CRCP overlay of 5 to 8 in. of asphalt concrete with 14 to 28 in. of aggregate subbase. Surveys of the sections in 1988 indicated satisfactory performance (CRSI 1988), and the actual cumulative traffic over the sections was significantly greater than the design traffic after 20 years (Sriraman and Zollinger 1999).

Table B.3. Performance data for CRCP overlays on asphalt-surfaced pavements in Oregon

Location	Overlay type	Overlay construction year	Status	Cumulative millions of ESALs ¹ (traffic years)	Pavement condition ² (2018)	IRI data (2018)
I-5, Jackson County	11 in. CRCP	1989	In Service 2020	36.5 (1989 to 2020)	82	98
I-5, Douglas County	11 in. CRCP	2017	In Service 2020	7.9 (2017 to 2020)	100	69
I-84, Baker County	10 in. CRCP	1985	In Service 2020	40.4 (1985 to 2020)	79	108
I-5, Marion County	8 in. CRCP	1976	Overlaid 1998	98 (1976 to 1998)	64 ³	97 ³

¹ Equivalent single axle loads (ESALS) were estimated from 2018 Oregon Traffic Monitoring System (OTMS) data using the growth rate of the 2018 traffic data.

² Pavement condition is rated on a 100 to 0 point scale, where 100–95 is very good, 94–76 is good, 75–46 is fair, 45–25 is poor, and 25–0 is very poor.

³ These values were measured before the asphalt overlay was placed in 1998 over the CRCP overlay.

Table B.3 provides a summary of performance details for four CRCP overlays constructed in Oregon between 1976 and 2017, with wear from studded tires and chains, not punchouts, being the main distress. Note that the CRCP overlay on I-5 in Marion County was overlaid with asphalt in 1998 because of studded tire wear, not structural failures.

In the 1970s, the Texas Department of Transportation (TxDOT) constructed an 8 in. CRCP overlay over an asphalt-surfaced pavement on I-40 in Potter County (CRSI 1973, PCA 1976). The existing pavement structure consisted of 12 to 16 in. of flexible base with 3 in. of asphalt concrete surface (CRSI 1973). The overlay’s performance was reported as excellent after a few years in service (PCA 1976). In addition, thin CRCP overlays on asphalt-surfaced pavements have been placed in Texas for transition areas between concrete on asphalt-bonded (COA-B) overlays and other pavement types (Chen et al. 2016).

In France, CRCP overlays over asphalt-surfaced pavements are typically 6.5 in. thick (Tayabji et al. 1998). South Africa has seen excellent performance for its busiest roadway with a 6 in. CRCP overlay of asphalt concrete (Brink and Pickard 2008).

Continuously Reinforced Concrete Pavement Overlays on Concrete Pavements

CRCP overlays on concrete pavements have a higher initial cost than JPCP overlays because of the added reinforcement and labor costs but offer long service lives with minimal maintenance, minimal reflective cracking, and continuous pavement smoothness (Heckel and Wienrank 2018, Roesler et al. 2016, CRSI 1988, CRSI 1973, Renner 1977). CRCP overlays can be bonded or unbonded to the existing concrete pavement substrate,

although the experience with CRCP overlays in the US and internationally has overwhelmingly been with unbonded overlay systems.

Unbonded CRCP Overlays on Concrete Pavements

In a 1975 survey of 29 CRCP overlay sections in the US, 27 were unbonded or partially bonded overlays on concrete pavement and were 6 in. thick or thicker (PCA 1976). Moreover, almost all CRCP overlays constructed in the past two decades have been unbonded.

Unbonded CRCP overlays have ranged from 6 to 12 in. thick and are commonly 8 to 12 in. thick, though in France CRCP overlays over JPCP are typically 7 in. thick (Tayabji et al. 1998). Typical unbonded CRCP overlays are designed with a steel content of 0.6% to 0.8% using No. 5 to No. 7 bars and are placed over a 2 to 3 in. dense-graded asphalt concrete separation layer. For unbonded overlays, the existing concrete pavement is almost always left intact, with the required partial- and full-depth repairs made to the existing structure prior to placement of the separation layer. Major principal arterials are excellent candidates for unbonded CRCP overlays.

The first CRCP overlay in the US was constructed in 1959 on I-35 in Texas. The project involved a 7 in. unbonded CRCP overlay on an existing 6 in. concrete pavement constructed in 1934 and included a 3.5 in. asphalt separation layer (CRSI 1988, CRSI 1973, PCA 1976, Sriraman and Zollinger 1999). Table B.4 presents several examples of this type of overlay that have since been constructed. As the table shows, Illinois has the most experience with unbonded CRCP overlays, having constructed several overlays of this type since 1967, with the majority of the state’s overlays constructed in the past 25 years (Roesler et al. 2016, Heckel and Wienrank 2018).

These overlays have had actual and estimated service lives between 20 and 40 years, and the currently in-service overlays exhibit IRI values of approximately 70 in./mi and have excellent condition ratings. In 2019, the California Department of Transportation (Caltrans) constructed 84 lane miles (14 centerline miles) of CRCP

overlays on I-8 as part of a 48 mi rehabilitation project in Imperial County and in 2021 plans to construct another major CRCP overlay of a JPCP (a 7.9 mi project with four lanes) on SR-14 in Kern County. Both of these projects are shown in Table B.4.

Table B.4. Examples of unbonded CRCP overlays on concrete pavement in the US

State	Location	Existing pavement	Existing pavement construction year	Overlay type	Overlay construction year	Project length	Notes
California	I-8, Imperial County	8.4 in. JPCP	1969	9 in. CRCP	2019	14 mi	ADT = 8,350 with 26% trucks
California	SR-14, Kern County	7.8 in. JPCP		10 in. CRCP	2021	7.9 mi	ADT = 17,410 with 10% trucks
Texas	I-35W, Burleson	9 in. JPCP	1936	6 in. CRCP	1965	8.78 mi	ADT = 22,000 with 14% trucks
Texas	I-45W, Galveston	JPCP		6 in. CRCP	1972-76	15.5 mi	ADT = 50,000
Texas	I-10, El Paso	8 in. CRCP		6.5 in. CRCP	1996		
Illinois	I-70, Bond County	8 in. JRCP	1939	6, 7, and 8 in. CRCP	1967	4 mi	ADT = 14,000 with 34% trucks
Illinois	I-55, Springfield	7 in. JRCP	1933	8 in. CRCP	1970	4.2 mi	ADT = 24,600 with 15% trucks
Illinois	I-55, Springfield	10 in. JRCP	Mid-1950s	9 in. CRCP	1976	3 mi	ADT = 17,000 with 22% trucks
Illinois	I-74, Knox County	7 in. CRCP	1969	9 in. CRCP	1995	7.9 mi	Design ESALs = 24 million
Illinois	I-88, Whiteside County	8 in. CRCP	1975	9 in. CRCP	2001		Design ESALs = 16.2 million
Illinois	I-70, Clark County	8 in. CRCP	1969	12 in. CRCP	2002		ADT = 24,000 with 42% trucks
Illinois	I-57/64, Mt. Vernon	8 in. CRCP (rubblized)	1969	10 in. CRCP	2014		Design ESALs = 80 million
Arkansas	I-40/55, West Memphis	9 in. JPCP	1951	6 in. CRCP	1972	1.7 mi	ADT = 27,000 with 25% trucks
Arkansas	I-55, West Memphis	9 in. JPCP		6 in. CRCP	1980	2.2 mi	ADT = 26,600 with 28% trucks
Indiana	I-465, Indianapolis	9 in. JRCP		6 in. CRCP	1969		ADT = 9,000
Indiana	I-69, Indianapolis	9 in. JRCP		6 in. CRCP	1971		ADT = 20,200
Pennsylvania	Erie County	10 in. JPCP	1960–1962	7 in. CRCP	1974–1976		
Oregon	I-5, Jackson County	11.5 in. HMA	1965	11 in. CRCP	1989	11.44 mi	ADT = 17,000 with 27% trucks
Oregon	I-5, Douglas County	12 in. HMA milled to 4 in.	1955	11 in. CRCP	2017	7.37 mi	ADT = 22,600 with 37% trucks

Table B.4 continued on following page

Table B.4 continued from previous page

State	Location	Existing pavement	Existing pavement construction year	Overlay type	Overlay construction year	Project length	Notes
Oregon	I-84, Baker County	11 in. HMA	1972	10 in. CRCP	1985	11.75 mi	ADT = 11,200 with 34% trucks
Oregon	I-5, Marion County	4 in. HMA	1954/1955	8 in. CRCP	1976	12.35 mi	ADT = 97,800 with 16% trucks
Wisconsin	US-16, Waukesha County	9 in. JPCP	Early 1960s	7 in. CRCP	1973	1.2 mi	ADT = 9,500 with 6% trucks
Wisconsin	I-94, Jackson and Moore Counties	10 in. JPCP		8 in. CRCP	1980		
Mississippi	I-20, Vicksburg	9 in. JRCP	1955	6 in. CRCP	1971	2.1 mi	
Mississippi	I-59, Jones County	8 in. CRCP		6 in. CRCP	1981		
Georgia	I-75, Monroe and Macon-Bibb Counties	8 and 9 in. JPCP	1954	7 and 8 in. CRCP	1973	13.6 mi	ADT = 13,500 to 30,000
Georgia	I-85, Gwinnett County	9 in. JPCP		3, 4.5, and 6 in. CRCP	1975	1 mi	ADT = 17,200 with 32% trucks
Maryland	I-70, Howard County	9 in. JRCP		6 in. CRCP	1971	9.1 mi	
Maryland	I-70, Howard County	9 in. JRCP		6 in. CRCP	1971	6.0 mi	
Maryland	I-70, Howard County	9 in. JPCP		6 in. CRCP	1972	10.9 mi	
Maryland	I-83, Baltimore County	JRCP		6 in. CRCP	1973	3.1 mi	ADT = 12,300
Connecticut	I-86	8 in. JPCP		6 in. CRCP	1975-1976		
North Dakota	I-29	8 in. JPCP	1958	6 in. CRCP	1972	4.2 mi	ADT = 2,000 with 15% trucks
North Dakota	I-29	8 in. JPCP	1958	6 in. CRCP	1974-1975	4.7 mi	ADT = 1,275 with 16% trucks

Table B.5 summarizes the performance data for the seven unbonded CRCP overlays in Illinois presented in Table B.4 (Heckel and Wienrank 2018, IDOT 2019). Of the seven sections that have been constructed, four are still in service as of 2020. The Illinois Department of Transportation (IDOT) Condition Rating Survey (CRS) results and IRI data included in Table B.5 indicate that the existing CRCP overlays are performing well in terms of condition and ride quality. The three CRCP overlay sections that have been rehabilitated all experienced significantly greater traffic than designed. For these three overlays, the cumulative traffic volumes at the end of service were 175%, 222%, and 174% those of the 20-year design traffic volumes for the sections on

I-70 in Bond County (1967–1987), I-55 in Springfield (1970–2001), and I-55 in Springfield (1976–1997), respectively (Heckel and Wienrank 2018).

Extrapolating the current IDOT CRS data in Table B.5 to a “poor” condition rating of 4.5, the predicted age and cumulative traffic at the end of service for the four in-service sections are 41 years and 208% of design traffic for I-74 in Knox County, 40 years and 235% of design traffic for I-88 in Whiteside County, 36 years and 102% of design traffic for I-70 in Clark County, and 28 years and 161% of design traffic for I-57 in Mt. Vernon (Heckel and Wienrank 2018).

Table B.5. Performance data for unbonded CRCP overlays on concrete pavement in Illinois

Location	Overlay type	Overlay construction year	Status	Cumulative millions of ESALs (traffic years)	IDOT CRS value*	IRI value
I-70, Bond County	6, 7, and 8 in. CRCP	1967	Removed from service 1987	23.4 (1967–1987)	5.7**	
I-55, Springfield	8 in. CRCP	1970	Removed from service 2001	38.1 (1970–2001)	5.5**	
I-55, Springfield	9 in. CRCP	1976	Removed from service 1997	27.5 (1976–1997)	5.7**	
I-74, Knox County	9 in. CRCP	1995	In service 2020	29.6 (1995–2020)	7.8	68
I-88, Whiteside County	9 in. CRCP	2000–2001	In service 2020	17.8 (2001–2020)	7.8	60
I-70, Clark County	12 in. CRCP	2002	In service 2020	59.1 (2002–2020)	7.9	69
I-57/64, Mt. Vernon	10 in. CRCP	2014	In service 2020	25.5 (2014–2020)	8.2	70

* IDOT CRS values range from 9.0 for a newly constructed pavement to 1.0 for a totally failed pavement. Values ranging from 9.0 to 7.6 are “excellent,” 7.5 to 6.1 are “good,” and 6.0 to 4.6 are “fair.” A value of 4.5 or lower is “poor.” Preservation treatments are considered for Interstates when the IDOT CRS value reaches 5.5.

** At the end of service

Bonded CRCP Overlays on Concrete Pavements

A bonded CRCP overlay of an existing CRCP or JPCP is only economically viable if pre-overlay repairs can be performed cost-effectively, that is, with few or no pre-overlay repairs required. Given that a pavement in very good condition with limited distress is required for a bonded CRCP overlay, overlays of this type are seldom considered during the design stages of a rehabilitation project. Most bonded CRCP overlays over JPCP or CRCP have been constructed in Texas (Choi et al. 2018, Sun et al. 2011, Sriraman and Zollinger 1999, Chen and Hong 2014, Ryu et al. 2013, Delatte Jr. et al. 1998, Kim and Won 2008), Iowa (Sriraman and Zollinger 1999, Betterton et al. 1984, Darter and Barenberg 1980), and South Korea (Ryu et al. 2009). Bonded concrete overlays, including CRCP overlays, are typically 3 to 4 in. thick (Smith et al. 2002).

One of the first bonded CRCP overlays was a 4 in. overlay constructed in Greene County, Iowa, in 1973 over a concrete pavement constructed in 1921–1922 (Sriraman and Zollinger 1999). This overlay was part of an experimental section that included many alternative overlay designs. After 10 years in service, a field survey reported that the CRCP overlay was performing well (Betterton et al. 1984).

Several bonded CRCP overlays were constructed on I-610 in Houston, Texas, in the 1980s. A number of the sections were reported to have satisfactory performance after a few years in service (Sriraman and Zollinger 1999), although some areas of delamination had been reported (Delatte Jr. et al. 1998), and after 20 years in

service the performance of these sections was reported to be still satisfactory (Kim and Won 2008). A recent field study of multiple bonded CRCP overlays constructed over the past 20 years in Texas showed that performance varied, with the condition of the existing concrete pavement, overlay thickness, and pavement-overlay interface bonding being important factors in positive performance (Choi et al. 2018).

Evaluation of the Existing Pavement Structure

As with any overlay design, the existing pavement structure needs to be evaluated before an overlay can be selected and placed. See [Chapter 2](#) of this guide for information on evaluating existing pavements.

When the existing pavement is JPCP or CRCP, an unbonded CRCP overlay with an asphalt concrete separation layer is a viable option if repairs can be made to the existing pavement structure and subsurface drainage issues can be addressed cost-effectively. A condition assessment is required to determine the necessary repairs prior to placement of the overlay. If the required repairs are especially extensive and expensive (e.g., requiring >5% patching), then an option is to rubblize the existing concrete pavement prior to placement of the asphalt separation layer and CRCP overlay. Rubblization may be an effective pre-overlay treatment if the existing JPCP or CRCP exhibits materials-related distresses such as alkali-silica reaction, D-cracking, or freeze-thaw damage.

For CRCP overlays on asphalt-surfaced pavements, [National Cooperative Highway Research Program \(NCHRP\) Synthesis 388](#) (Tenison and Hanson 2009) provides a concise overview of pre-overlay treatment options based on surveys of state departments of transportation (DOTs).

Design

Compared to JPCP overlays, CRCP overlays can provide a longer service life with greater smoothness and a thinner slab thickness. AASHTOWare Pavement ME Design (Roesler et al. 2016) can be used for the structural design of CRCP overlays. Older design methods (e.g., AASHTO 1993) are not recommended because of their significant empiricism and necessary extrapolation. Roesler and Hiller (2013) provide an overview of inputs, sensitivities, and examples for the design of CRCP using AASHTOWare Pavement ME Design.

For CRCP overlays, the strong support from the existing pavement structure results in a design thinner than that of a new JPCP or CRCP section. The design steel content in CRCP overlays should be similar to that of conventional CRCP (i.e., 0.6% to 0.8%). Edge support is very important for CRCP overlay performance, and therefore a tied concrete shoulder (CRCP or JPCP) is a preferred option (Roesler et al. 2016). For tied concrete shoulders with CRCP overlays, tie bars should not be placed within 18 in. of a shoulder contraction joint, the joint spacing should be limited to a maximum of 20 ft, and the tie bar size should not exceed No. 5 or No. 6.

As with conventional CRCP, the primary failure mode to be considered during CRCP overlay design is punchouts. AASHTOWare Pavement ME Design is sensitive to certain design inputs, such as steel content, slab-base friction, and thermal/drying shrinkage, so these inputs should be carefully selected to control transverse crack development and crack width. Additional design and construction considerations to minimize distresses include the provision of a stripping-resistant asphalt separation layer, subsurface drainage to minimize foundation layer erosion, and concrete mixture constituents that minimize transverse crack spalling.

Materials and Concrete Mixtures

Concrete Mixtures

The constituents and proportioning for CRCP overlay mixtures are similar to those for conventional CRCP mixtures, with particular attention paid to limiting

the peak temperature of hydration, concrete drying shrinkage, and coefficient of thermal expansion.

Reinforcing Steel

The reinforcing steel used in CRCP overlays is the same as that used in conventional CRCP, both in terms of steel properties (bar size and spacing) and total steel content (typically 0.6% to 0.8%). Steel tie bars are used for all longitudinal construction and contraction joints. In regions where large quantities of deicing chemicals are employed during winter maintenance operations, epoxy-coated reinforcing steel can be specified to limit the risk of long-term steel corrosion (Roesler et al. 2016). A recent evaluation of epoxy-coated reinforcing steel for use in CRCP suggested that it may not be necessary because of the large cover depth of the steel (>3.5 in.) and the size of the transverse crack widths (<0.5 in.) (Montanari et al. 2021).

While the inclusion of conventional reinforcing steel is the standard practice, some CRCP overlays of flexible pavements have been constructed with hybrid fiber-reinforced polymer bars (Złotowska et al. 2019). Some CRCP overlays have also used steel macrofibers in the concrete (Kim and Won 2008).

Separation Layer (for Unbonded Overlays)

Despite some applications of alternative separation layer materials that exhibited mixed performance (Sriraman and Zollinger 1999, Roesler et al. 2016), asphalt concrete is the recommended choice for the separation layer in unbonded CRCP overlays (Roesler et al. 2016). Geotextile should not be used (Cackler 2017) given the low friction that geotextile provides during transverse crack development (Zollinger et al. 2014). To prevent punchouts, the asphalt separation layer needs to be non-erodible and should be a minimum of 1 in. thick. The best performing separation layer for CRCP overlays in Illinois has been dense-graded asphalt concrete.

Construction

Aside from pre-overlay repairs and the placement of a dense-graded asphalt concrete separation layer (for unbonded overlays), the general construction process for a CRCP overlay is similar to that for conventional CRCP. Detailed guidelines for the construction of conventional CRCP and CRCP overlays can be found in *Continuously Reinforced Concrete Pavement Manual: Guidelines for Design, Construction, Maintenance, and Rehabilitation* (Roesler et al. 2016). This section summarizes some key construction considerations unique to CRCP overlays.

Pre-overlay Repairs

For CRCP overlays on both asphalt-surfaced and concrete pavements, the pre-overlay repairs described in Tenison and Hanson (2009) should be considered.

For unbonded CRCP overlays on concrete pavements, if the existing concrete pavement is severely distressed, then rubblization can be considered prior to placement of the asphalt separation layer and the CRCP overlay. Before rubblization, the existing pavement structure should have a stable subgrade and adequate section drainage (e.g., underdrains may need to be installed prior to rubblization). The IDOT constructed an unbonded CRCP overlay section approximately 5 mi long on a rubblized CRCP in 2014 near Mt. Vernon, Illinois, where I-57 and I-64 merge. As of 2021, this overlay has a very good condition rating and an IRI of 70 in./mi.

Terminal or End Treatment Joints

Like with conventional CRCP, the terminal or end treatment joint details in CRCP overlays should be given special attention because maintenance problems can arise at these joints. Transition slab designs with sleeper slabs are now preferred over lugs and wide-flange beams for terminal or end treatment joints (Jung et al. 2007). For this overlay type, transition slab systems are significantly easier to construct and offer lower maintenance costs for the joints. Details of the transition and sleeper slabs are shown in Figures B.2, B.3, and B.4. The Illinois State Toll Highway Authority recently implemented these types of end treatments on Illinois Route 390.

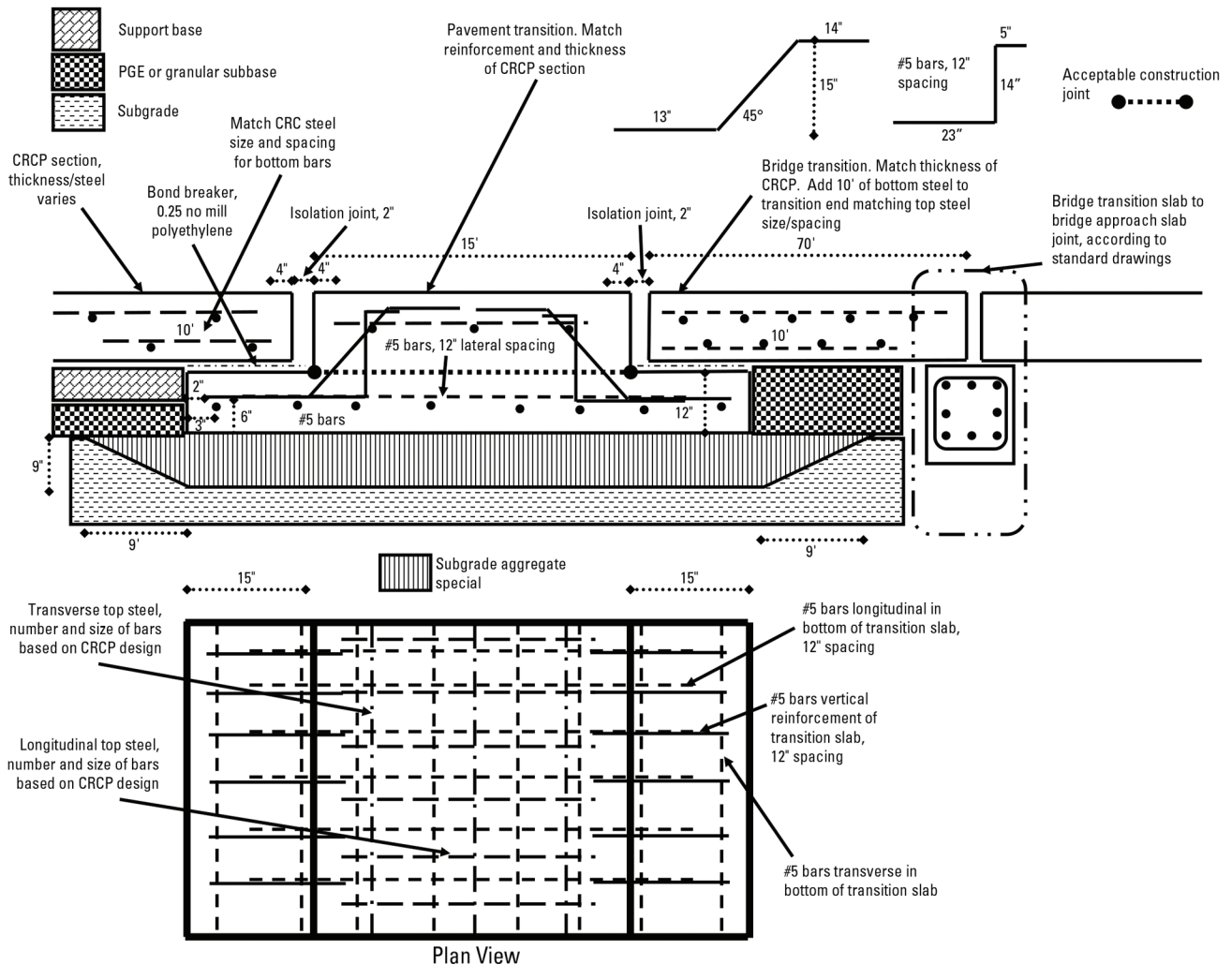

Recreated from The Illinois State Toll Highway Authority, used with permission

Figure B.2. Transition slab details for an end treatment of a CRCP overlay at a bridge

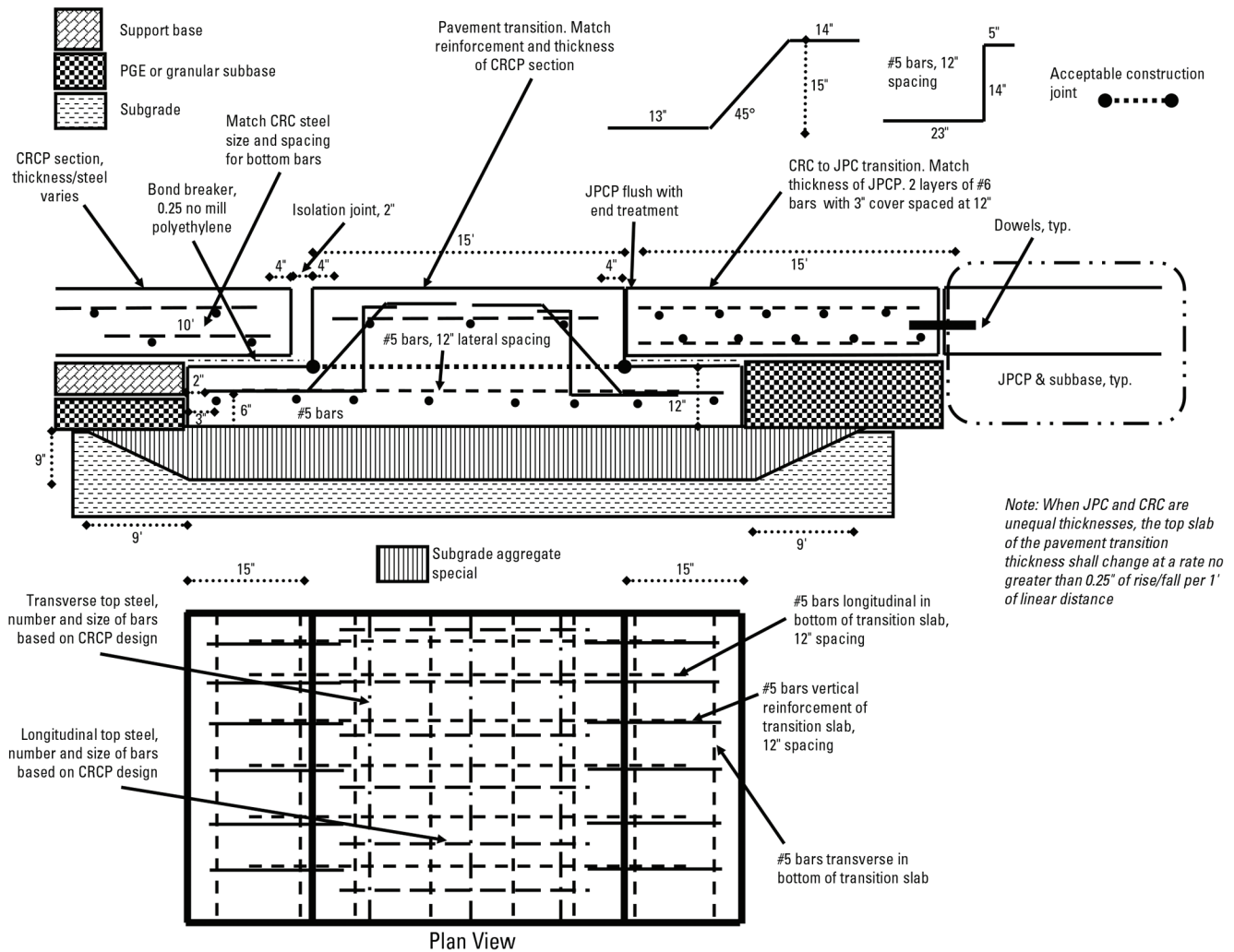

Recreated from The Illinois State Toll Highway Authority, used with permission

Figure B.3. Transition slab details for an end treatment of a CRCP overlay at a JPCP

Life-Cycle Cost Analysis of Continuously Reinforced Concrete Pavement Overlays

Life-cycle cost analysis (LCCA) can be a helpful tool in deciding whether to pursue a concrete overlay strategy and in choosing the appropriate overlay type for a given project. The outcome of an LCCA depends on the structural design of a particular roadway section and the analysis period selected. For a CRCP overlay in particular, the lower maintenance requirements over its service life generally make it a better choice when the agency's analysis period is greater than the design life of the roadway and includes at least one rehabilitation cycle, despite the higher initial costs of CRCP resulting from the reinforcing steel and placement costs.

To illustrate the life-cycle costs of CRCP overlays, this section describes an LCCA comparing an unbonded

CRCP overlay and an unbonded conventional JPCP overlay on an existing concrete pavement.

Scenario

To compare the life-cycle costs of an unbonded CRCP overlay and an unbonded conventional JPCP overlay on an existing concrete pavement, AASHTOWare Pavement ME Design was used to develop designs for both overlay types on a principal arterial with a design life of 20 years. The roadway in this scenario was a four-lane Interstate highway with 12 ft lanes in the central Midwest. The existing 8 in. thick JPCP was constructed 25 years ago and at the time of the scenario was in fair to poor condition. The existing JPCP was supported by a 10 in. granular base layer with a resilient modulus of 18,000 psi and an A-7-6 soil with a resilient modulus of 8,000 psi.

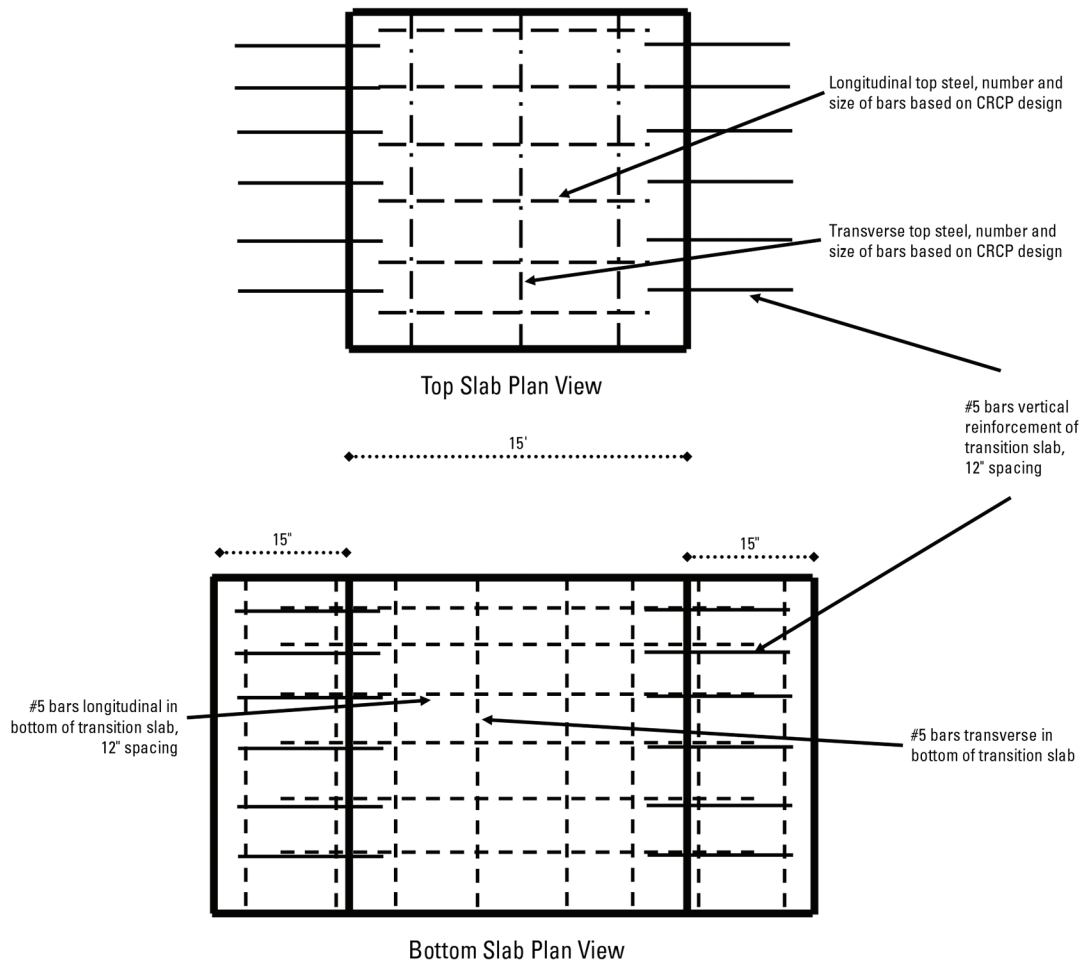

Recreated from The Illinois State Toll Highway Authority, used with permission

Figure B.4. Transition slab details for the end treatment and terminal joints of a CRCP overlay

The current average daily truck traffic (ADTT) at the time of the scenario was 9,000 and the average daily traffic (ADT) was 30,000, with traffic growth assumed to be 4% compounded. The vehicle class distribution was represented in the software by Truck Traffic Classification 1 (TTC1), which consists of 8.5% Class 5, 7.6% Class 8, and 74% Class 9 vehicles. For 20 years of traffic, the equivalent single axle loads (ESALs) were estimated to be 80 million.

In the new overlay designs, the necessary pre-overlay treatments were assumed to be the same for both the JPCP and CRCP overlay options. The hot-mix asphalt (HMA) separation layer was 1 in. thick with a PG 64-22 binder. Both new overlay designs included asphalt

shoulders. The concrete used in both overlay designs had the same constituents and material design values.

Both overlays were designed to be 10 in. thick. For the JPCP overlay design, the joint spacing was selected to be 15 ft with 1.5 in. steel dowels. The design failure criteria were set at 10% slab cracking, 0.10 in. joint faulting, and a terminal IRI of 172 in./mi with a reliability of 90%. For the CRCP overlay design, the design steel content was 0.7% with No. 6 bars placed at 3.5 in. from the slab surface to the top of the steel. The design failure criteria were set at 10 punchouts per mile and a terminal IRI of 172 in./mi with a reliability of 90%. The designs developed in AASHTOWare Pavement ME Design for the JPCP and CRCP overlays are shown in Table B.6.

Table B.6. CRCP and JPCP overlay designs developed in AASHTOWare Pavement ME Design

Overlay type	Design life (years)	Estimated traffic (ESALs)	Slab thickness (inches)	Predicted IRI at design life (inches/mile)
JPCP	20	80x10 ⁶	10	127
CRCP	20	80x10 ⁶	10	101

Principles and Parameters

The LCCA analysis followed the principles of the Federal Highway Administration’s (FHWA’s) RealCost software (version 2.5). For the comparison of the two concrete overlay types, the costs of constructing concrete pavements were based on estimated prices in the Midwest. The preservation schedules for JPCP and CRCP were based on a schedule recommended by the Illinois State Toll Highway Authority and found in Ferrebee and Roesler (2018). These preservation schedules are based on experience with the climate and construction materials of northern Illinois and may not be exactly applicable to other locations. Tables B.7 and B.8 summarize the actual preservation schedules assumed for the JPCP and CRCP overlay analyses, respectively.

The LCCA was conducted for analysis periods ranging from 20 to 55 years to demonstrate the effect of service life on the net present value (NPV) of each overlay option. The initial costs of the two overlay types were computed for one lane mile of the JPCP and CRCP overlays without consideration of shoulders or maintenance of traffic. It was assumed that the costs

related to shoulders and maintenance of traffic were essentially equivalent for both options, so the main cost difference was in the initial structural design details and the preservation schedules in Tables B.7 and B.8. The main cost difference between the CRCP and JPCP overlays resulted from the different amounts of steel reinforcement used and the different placement costs. The initial costs per lane mile for the CRCP and JPCP overlays were \$368,000 and \$317,000, respectively.

As of 2020, the current 30-year real discount rate reported by the US Office of Management and Budget (OMB) is 0.4% (OMB 2020). The mean discount rate reported by state DOTs in 2019 was 2.8% (Folkestad 2019). Many agencies are moving to the updated 30-year real discount rate, while some states are still using higher values (between 3% and 5%) reflecting historical discount rates. For this LCCA, discount rates of 0.4% (current), 1.5%, 3.0%, and 5.0% were used to compute the NPV for each overlay option for each analysis period.

Table B.7. CRCP overlay preservation schedule

Year	Activity
0	Initial Construction
10	Patch 0.5%
25	Patch 0.5%
	Diamond Grind Surface
33	Patch 1.0%
	4 in. HMA Overlay
40	Rout and Seal Cracks (50% centerline length)
48	Mill 4 in.
	Patch 1.0%
	4 in. HMA Overlay
55	Rout and Seal Cracks (50% centerline length)
63	Mill 4 in.
	Patch 1.0%
	4 in. HMA Overlay
70	Rout and Seal Cracks (50% centerline length)
78	Reconstruction

Table B.8. JPCP overlay preservation schedule

Year	Activity
0	Initial Construction
11	Seal Joints
18	Seal Joints
	Patch 2.5%
25	Seal Joints
	Patch 2.5%
	Diamond Grind
32	Patch 5%
	4 in. HMA Overlay
38	Rout and Seal Cracks (50% centerline length)
45	Mill 4 in.
	Patch 4%
	4 in. HMA Overlay
50	Rout and Seal Cracks (50% centerline length)
57	Mill 4 in.
	Patch 4%
	4 in. HMA Overlay
62	Reconstruction

Results

The effect of the analysis period on the NPVs of the CRCP and JPCP overlays is shown in Figure B.5 for the four discount rates selected. With the same slab thickness for both the JPCP and CRCP overlay designs, CRCP overlays begin to have lower life-cycle costs between 25 and 30 years for discount rates around 3% or less. For higher discount rates, such as 5%, the cost benefits of CRCP overlays are not realized until the analysis period is approximately 33 years because of the initial costs of and preservation schedule for each overlay type.

Selecting a higher discount rate without justification reduces the NPV of future preservation treatments and essentially makes pavement types that require more frequent preservation treatments more attractive in terms of life-cycle costs. In the past 15 years, this has not been the case with discount rates of 3.1% or less. However, current discount rates between 3% and 5% are unreasonable given current and recent discount rates as well as declining federal gasoline tax revenue.

Agencies should consider applying the current real discount rate currently reported in Appendix C of OMB Circular A-94 (OMB 2020) as opposed to historical discount rates, which do not adequately assess the financing of a project now and into the future.

Another factor affecting the selection of a CRCP versus JPCP overlay based on a life-cycle cost analysis is current steel prices. Figure B.6 shows the effect of steel prices on the NPVs of the CRCP and JPCP overlays at a discount rate of 3%. In the figure, a price of 0% represents a steel base price of \$200 per ton, and prices of 25% and 50% represent steel prices of \$250 and \$300 per ton, respectively. When the price of steel per ton is \$200 (0% in Figure B.6), a CRCP overlay is the preferred option for analysis periods greater than 25 years. When the initial cost of steel at the time of construction rises 25% and 50% higher than \$200 per ton, CRCP overlays become more attractive for analysis periods greater than 32 and 45 years, respectively.

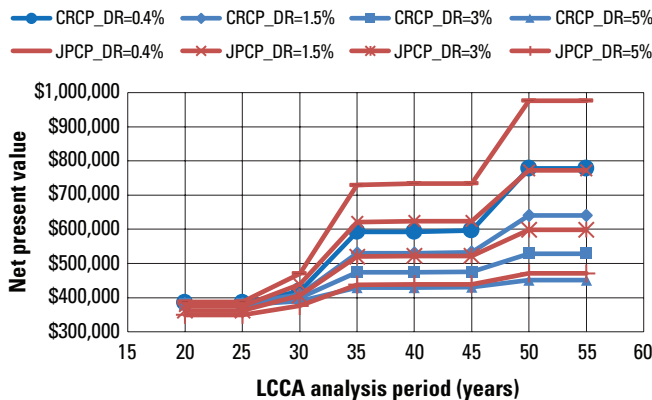

Adapted from Jeffery Roesler, used with permission

Figure B.5. Net present value of CRCP and JPCP overlay designs for various discount rates

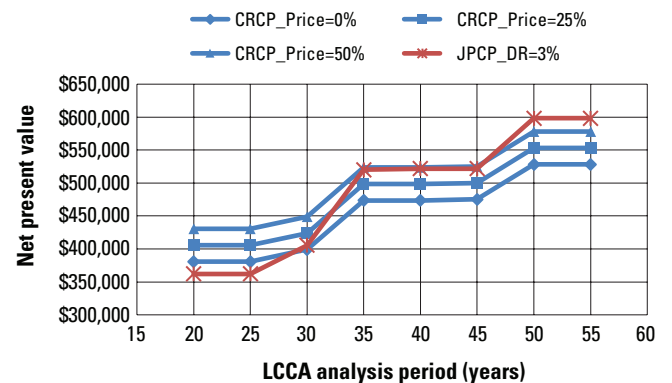

Adapted from Jeffery Roesler, used with permission

Figure B.6. Net present value of CRCP and JPCP overlay designs for a discount rate of 3.0% and various steel prices

Appendix C

Concrete on Concrete–Bonded Overlays

Key Features and Applications	114
Evaluation of Existing Pavement Structures	115
Design Features	116
Bond	116
Mixture Design	116
Thickness Design	117
Joint Spacing and Layout	117
Drainage	117
Construction	117
Pre-overlay Repairs	117
Surface Preparation	118
Surface Cleaning	118
Concrete Placement	118
Curing	119
Joint Sawing	119
Joint Sealing	119
Opening Strength	119
Case Studies of Concrete on Concrete–Bonded Overlays	120
Case Study 1: Thin (3 in.) Bonded Overlay on Iowa 3 East of Hampton, Iowa	120
Case Study 2: Thin (3 in.) Bonded Overlay on 15th Street in Del City, Oklahoma	121

Key Features and Applications

A concrete on concrete–bonded (COC–B) overlay is placed on an existing pavement in good structural condition and is designed to form a monolithic structure with that pavement (Figure C.1). When properly designed and constructed, this type of overlay offers the following benefits (Tayabji et al. 2009):

- Extends a pavement’s service life by 20 to 25 years. In some cases, the life of a thin bonded overlay has been known to exceed 35 years.
- Requires little maintenance over its service life, resulting in reduced life-cycle costs.
- Can be used with accelerated construction practices.
- Can accommodate specific traffic management constraints during construction.

At the same time, COC–B overlays have four key limitations:

1. Experience has shown that structural defects in the existing pavement will propagate into the overlay (Figure C.2). The remaining design life of the existing pavement must therefore be at least equal to that of the proposed overlay.
2. The sawcut joints of the overlay must be matched to those of the existing pavement to prevent differential movement between the existing pavement joints and the overlay joints. The depth of each sawcut joint must be the full depth of the overlay plus ½ in. into the existing pavement joint.
3. Each transverse joint must be at least as wide as the existing crack below the sawcut in the existing pavement to accommodate any slab movement.
4. As an important element of a successful COC–B overlay, the bond between the existing concrete pavement and the overlay must be of sufficient strength to withstand delamination. When the surface of the existing pavement is properly prepared, the bond between the existing slab and the overlay ensures that the layers act as a monolithic pavement.



ACPA, used with permission

Figure C.1. Thin bonded overlay of structurally sound concrete pavement



Greg Mulder, Iowa Concrete Paving Association, used with permission

Figure C.2. Deteriorated longitudinal crack in a COC–B overlay

Because the overlay and existing pavement form a monolithic structure, a COC–B overlay must be placed on an existing pavement in good structural condition. Because such pavements are rarely programmed for rehabilitation or preservation, this type of overlay has been used successfully in the United States for special, limited applications, such as to address major increases in traffic loads by adding structure to the existing pavement or to correct surface issues such as noise, smoothness, or minor defects (Figure C.3).

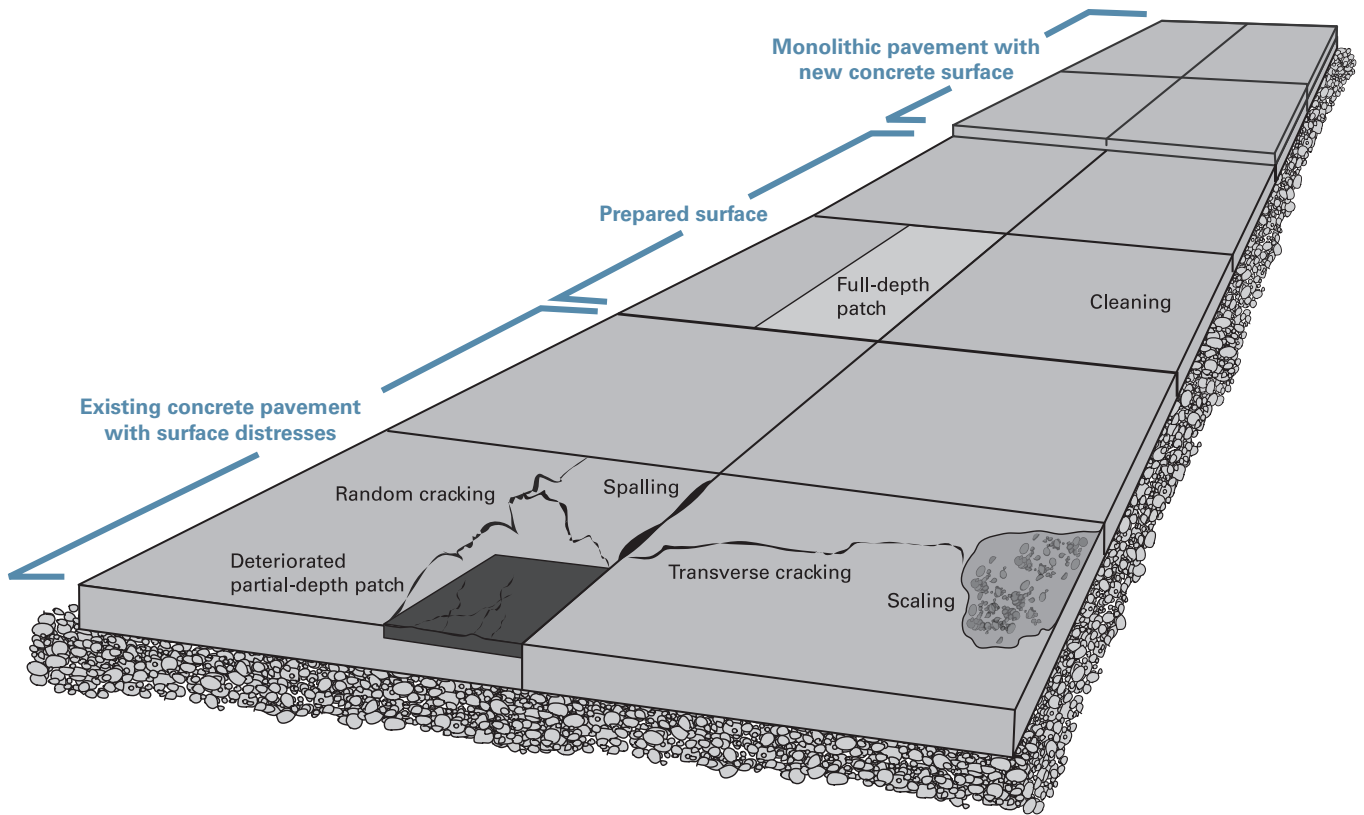

CP Tech Center

Figure C.3. Existing concrete pavement with minor surface distresses shown with a proposed COC–B overlay

COC–B overlays are not recommended solutions in any of the following situations:

- The joints of the existing concrete pavement exhibit materials-related distresses such as alkali-silica reactivity (ASR), D-cracking, or freeze-thaw damage.
- There is poor subgrade support or drainage. Poor drainage can lead to weakened subgrade support and/or increased susceptibility to freeze-thaw damage.
- There are vertical restraints on raising the profile, which in some urban situations can result in the removal and replacement of curb and gutter sections and driveways, intersection reconstruction, fixture adjustments, and other major work.
- There are numerous random cracks in the existing pavement that will be difficult to reestablish properly in the overlay.

Evaluation of Existing Pavement Structures

One of the first steps in determining whether an existing concrete pavement is a good candidate for a COC–B overlay is to evaluate the pavement to determine whether it is in—or can cost-effectively be repaired to be in—good structural condition. A pavement evaluation identifies and characterizes distress types, structural condition (e.g., cracking, ability to carry traffic loads, problems that may reflect into the overlay), functional performance (e.g., roughness, noise), and materials-related issues (e.g., freeze-thaw damage at the joints, ASR, D-cracking). See [Chapter 2](#) of this guide for more information about evaluating existing pavements.

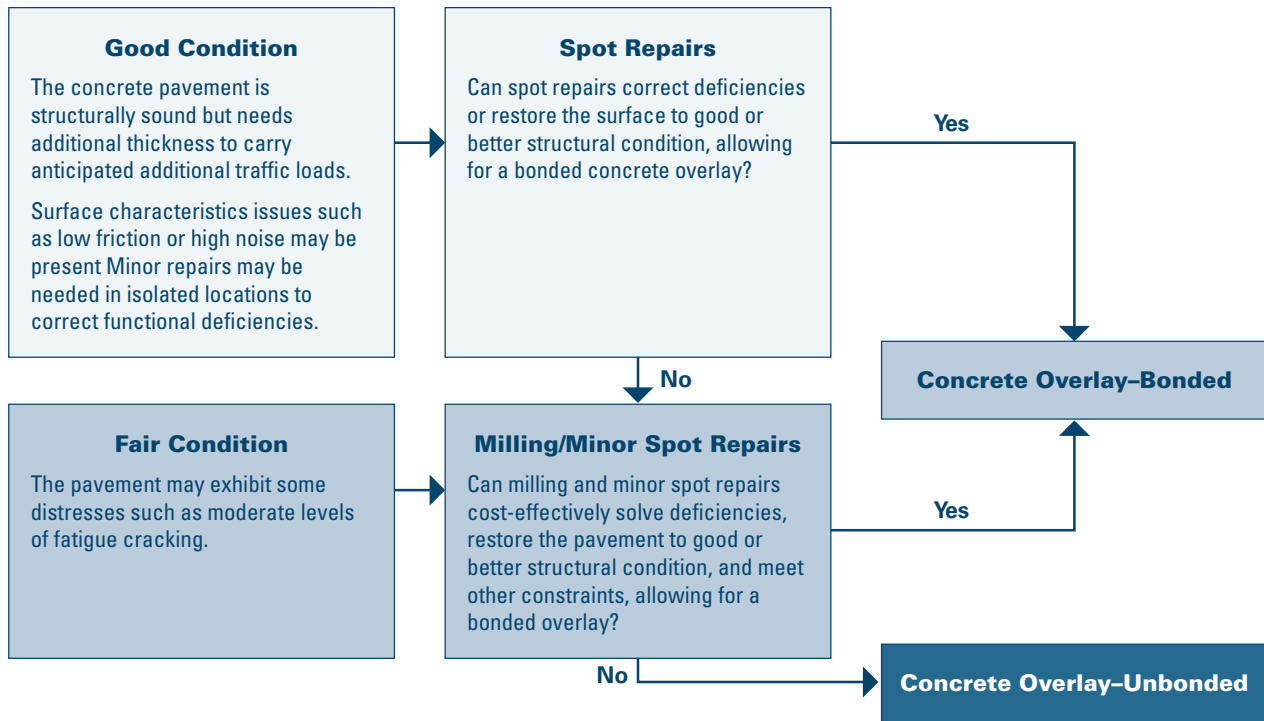

CP Tech Center

Figure C.4. Process for determining an appropriate overlay solution

Several factors should be considered when determining whether a COC–B overlay is appropriate for a given project, with the condition of the existing pavement being paramount. Figure C.4 illustrates the process for selecting an appropriate overlay solution. Note that the recommended overlay solutions are generally long-term fixes with 20 or more years of expected service life.

Design Features

Bond

The degree of the bond between the overlay and the existing pavement, or the amount of mechanical interlock present between the overlay and the structural layer immediately below, plays a major role in the behavior of and stress distribution through all layers in the overlaid pavement system. When the bond between the layers is complete, the overlay and existing pavement act monolithically with an effective thickness that is greater than that of either the overlay or the existing pavement. The combined system has a single neutral axis with respect to bending, and the maximum stresses at either the top or bottom of the system are greatly reduced.

The bond at the interface between the COC–B and the existing concrete is subject to considerable stress from concrete volume changes and loading. To mitigate this stress, a goal of preparing the surface of the existing

pavement before overlay placement is to provide a rough surface that enhances the bonding of the COC–B to the existing pavement. Once the surface of the existing pavement has been roughened and cleaned, the prepared surface should not be open to traffic.

Mixture Design

Conventional concrete mixtures are typically used for COC–B overlays. However, the materials must be selected carefully to minimize stresses at the interface between the overlay and the existing pavement that might affect bonding. Differences in moduli between the overlay and existing pavement layers can result in thermally induced stresses. The main factor affecting the modulus of concrete is coarse aggregate type, with high-modulus aggregate resulting in high-modulus concrete. Additionally, large differences in thermal expansion coefficients between the existing pavement and overlay concrete can result in increased stresses.

To minimize interface stresses, regardless of weather during placement, the overlay concrete and especially the aggregates used must be compatible with those used in the existing pavement. The basic premise for material compatibility in this regard is to use aggregates in the overlay concrete that produce moduli and thermal coefficients similar to those of the existing slab.

Thickness Design

Two primary software applications can help users determine the design thickness of a COC-B overlay.

AASHTOWare Pavement ME Design (<https://me-design.com/MEDesign>) is an implementation of the current mechanistic-empirical pavement design procedures developed by the American Association of State Highway and Transportation Officials (AASHTO). It combines a mechanistic approach to pavement structural analysis (using user inputs for loads, climate, and pavement structural data to compute critical pavement stresses, strains, and deflections) with empirical performance models developed from a large database of field measurements gathered from projects all over the United States. For concrete overlays, the designs produced by AASHTOWare Pavement ME Design reflect the interactions between pavement geometry (e.g., panel size and thickness, widened lanes), structural considerations (e.g., use of dowels and tie bars, shoulder type, use of steel reinforcement), local climatic factors, and concrete material and support layer properties. Users should have a thorough understanding of the pavement design procedure and the sensitivity of design inputs. The industry recognizes AASHTOWare Pavement ME Design as the best tool for highways and other federal and state roadways.

The American Concrete Pavement Association's (ACPA's) PavementDesigner.org (<https://www.pavementdesigner.org>), released in 2018, serves as the concrete pavement industry's recommended design methodology for all facilities that are not covered by AASHTOWare Pavement ME Design.

Joint Spacing and Layout

The jointing pattern for a COC-B overlay must match the jointing pattern of the existing pavement. This is necessary to avoid reflective cracking and to allow the overlay and existing pavement to act monolithically.

The depth of the transverse sawcut joints should be the full depth of the pavement system plus $\frac{1}{2}$ in. This depth prevents debonding if the width of the transverse joint is equal to or greater than the width of the underlying joint or crack in the existing concrete pavement. Figure C.5 shows a typical detail.

The sawcut depth of a longitudinal joint in an overlay 4 in. thick or less should be $T/2$. For an overlay greater than 4 in. thick, the sawcut depth of the longitudinal joint should be $T/3$.

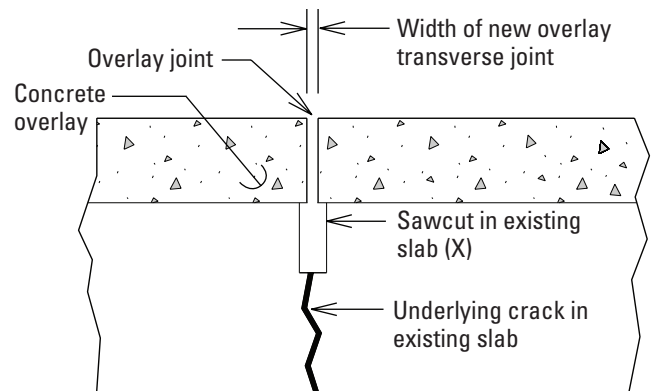

Note: Overlay joint width shall be equal to or greater than crack in the existing slab.

If "X" is 0.50 in. (13 mm) or greater, the underlying crack width in the existing slab should be measured. If crack is 0.25 in. (6.4 mm) or greater, and existing pavement does not have dowel bars, the joints should be evaluated to determine if load transfer rehabilitation is required to eliminate faulting. If there are numerous joints of this type, the existing pavement may not be a good candidate for a bonded overlay.

Recreated from Snyder & Associates, Inc., used with permission

Figure C.5. Cross section of a transverse saw joint in a COC-B overlay

Drainage

During the evaluation of the existing pavement and the design of the COC-B overlay, the existing subgrade drainage should be evaluated, and, if necessary, steps should be taken to ensure adequate drainage (e.g., retrofitting edge drains, using free-draining shoulder materials, and sealing transverse and longitudinal joints).

Construction

Steps in the construction of COC-B overlays include pre-overlay repairs, surface preparation and cleaning, concrete placement, curing, and joint sawing and sealing.

Pre-overlay Repairs

Pre-overlay repairs of the existing concrete pavement should not be extensive; if they are, the pavement is probably not a good candidate for a COC-B overlay. Surface defects (e.g., concrete scaling) are not considered a major concern but should be addressed before the overlay is placed. Other issues to address include random or working cracks, which require full-depth repairs, and voids detected under the existing concrete slabs. Existing asphalt patches should also be removed and replaced with concrete patches to provide more uniform and consistent bonding.

Surface Preparation

Surface preparation of the existing pavement involves producing a roughened surface that will enhance bonding between the existing pavement and the overlay. Surface preparation procedures include shotblasting, milling, and high-water pressure blasting. The most common and effective surface preparation procedure is shotblasting (Figure C.6). If milling is used to lower the pavement elevation, any resulting microcracking should be removed by shotblasting or high-pressure water blasting.

Surface Cleaning

Following surface preparation, the surface of the existing pavement should be cleaned to ensure adequate bonding between the existing pavement and the overlay. Cleaning may involve sweeping the concrete surface, supplemented by the use of compressed air to clean in front of the paver (Figure C.7). Paving should commence soon after cleaning to minimize the chance of contamination, and construction traffic should be minimized on the cleaned surface for similar reasons. If it is necessary to allow vehicles onto the surface, care should be taken not to contaminate the surface and compromise the bond.

Concrete Placement

Grade adjustments may need to be made to ensure that the overlay concrete is of the required thickness, and grout coating of the existing pavement's surface to enhance bonding is not recommended or required. Otherwise, conventional concrete paving practices and procedures are followed for the placement of COC-B overlays. Figure C.8 shows the placement of a thin COC-B overlay.



Todd Hanson, Iowa DOT, used with permission

Figure C.6. Shotblasting of a concrete surface



Jim Grove, Iowa DOT, used with permission

Figure C.7. Use of compressed air to clean existing concrete in front of the paver



ACPA, used with permission

Figure C.8. Placement of a thin COC-B overlay

Special attention should be given to adverse environmental conditions during paving. Hot, dry weather poses the greatest challenge for COC–B overlay placement because these conditions favor the loss of moisture from fresh concrete, and excessive water evaporation can cause volume changes large enough to promote debonding. If the surface temperature of the existing pavement is particularly high (e.g., in excess of 120°F), it is recommended that the surface be cooled by sprinkling with water, with any standing water removed using compressed air just ahead of the paver. The combination of high wind velocity, high air temperature, low relative humidity, and high concrete temperature is the most difficult of paving conditions due to the high potential for water evaporation.

Curing

Curing is critical for a COC–B overlay because the surface area-to-volume ratio of the overlay is greater than it is for concrete pavements of normal thickness. Moisture loss and the resulting drying shrinkage are approximately proportional to the surface area-to-volume ratio of the concrete placed. Curing compound should be applied such that the surface and vertical faces of the overlay are thoroughly coated and appear uniformly white like a sheet of paper.

When an overlay is placed in cooler weather, the concrete can set from the bottom up, delaying the sawing window. Temporarily covering the overlay with plastic sheeting after paving helps the concrete set properly, allowing time to mark the new overlay joints above the existing joint lines prior to joint sawing. Heating the concrete mixture may also be a consideration in cool weather. COC–B overlays should not be placed when the mixture temperature and the existing pavement temperature differ by more than 35°F.

Joint Sawing

Timely joint sawing is critical to prevent random cracking in COC–B overlays. Sawing must begin before debonding stress dominates in the overlay but after the concrete is strong enough that the joints can be cut without raveling. Experience has shown that an adequate number of saws must be available on-site for the joint sawing to keep pace with the construction operation.

Joint Sealing

To help prevent moisture entrapment, all joints in a COC–B overlay should be filled. Conventional joint filler materials and methods can be used, but the use of a backer rod is not recommended.

Opening Strength

Maintaining the bond between a COC–B overlay and the existing pavement is especially critical during the first few days after placement, when the overlay is susceptible to curling and warping stresses, especially at the pavement edges. Therefore, the bond must be protected by using proper curing practices (particularly at the pavement edges), minimizing relative humidity and temperature differentials between the existing pavement and the overlay, and keeping early traffic away from the pavement edges until an adequate bond strength has been achieved (usually when opening strength has been achieved).

Case Studies of Concrete on Concrete–Bonded Overlays

Case Study 1: Thin (3 in.) Bonded Overlay on Iowa 3 East of Hampton, Iowa

In September 1994, the Iowa Department of Transportation (Iowa DOT) constructed a 3 in. thick, 1.8 mi long COC–B overlay on Iowa 3, a state primary road, to address an increase in truck traffic generated by a liquid fertilizer plant that had opened at the west end of the city of Hampton. This project is documented in an Iowa DOT-sponsored study whose objectives were to determine the rate of bond strength development between concrete overlays and existing pavements and to evaluate nondestructive testing methods for determining concrete strength (Cable 1995).

The original 10 in. thick concrete pavement had been constructed in 1969 with 10 ft wide granular shoulders. Some slight spalling at the centerline joint was evident prior to overlay placement (Figure C.9).

The overlay was constructed in 1994 one lane at a time under traffic using pilot cars. A unique feature of the overlay was the use of 36 in. long, epoxy-coated, deformed No. 5 reinforcing bars to retard reflective cracking of mid-slab nonworking transverse cracks. The bars were attached to 42 crack locations in the existing pavement surface prior to overlay construction, as shown in Figure C.10. Although reflective cracking did occur, the cracks were hairline in size.

As of 2021, the COC–B overlay is in good condition after 27 years in service (Figure C.11), with the exception of a 0.25 mi long section (Figure C.12). At the west end of the overlay, the slight spalling evident in the centerline joint of the existing pavement in 1994 is now reflected into the overlay and is more severe.



Jim Grove, Iowa DOT, used with permission

Figure C.9. Existing concrete pavement in 1994 prior to overlay placement, with a shotblaster in operation and some spot spalling evident at the centerline joint



Jim Grove, Iowa DOT, used with permission

Figure C.10. Reinforcement over transverse cracks in the existing concrete pavement prior to overlay placement 1994



Greg Mulder, Iowa Concrete Paving Association, used with permission

Figure C.11. East end of the COC–B overlay on Iowa 3 in August 2021, showing pavement in fair to good condition



Greg Mulder, Iowa Concrete Paving Association, used with permission

Figure C.12. West end of the COC–B overlay on Iowa 3 in August 2021

Case Study 2: Thin (3 in.) Bonded Overlay on 15th Street in Del City, Oklahoma

In the fall of 1994, Del City, Oklahoma, constructed a 3 in. thick bonded asphalt overlay over an existing 7 in. thick concrete pavement that had been constructed in the 1970s. The project was on a 1.25 mi long segment of 15th Street, a four-lane commuter route.

In 2003, the city decided to cold-mill the 3 in. thick asphalt overlay and replace it with a 3 in. thick COC-B overlay. The average daily traffic on 15th Street at the time was approximately 7,500 with 5% trucks. Figure C.13 shows the existing asphalt prior to milling, and Figure C.14 shows the existing concrete pavement after the asphalt surface was milled. To match the grade of the existing gutters, asphalt was also milled in the curb and gutter sections (as shown in Figure C.14).

After the asphalt was cold-milled, any remaining asphalt was removed by hand and full-depth concrete patch repairs were performed at spot locations to remove nonstable panels. All portions of the milled concrete surface were shotblasted, removing any microcracking caused by milling and significantly roughening the surface for better bonding. Several No. 5 reinforcing bars with U-shaped bends were fastened over nonworking longitudinal cracks in the existing concrete, as shown in Figure C.15. The crack locations were reviewed 15 years after placement and were reported as tight cracks in the overlay. Figure C.16 shows the condition of the COC-B overlay in 2020.



Brent Burwell, ACPA, OK/AR Chapter, used with permission

Figure C.13. Existing 3 in. thick asphalt overlay on 15th Street prior to milling



Brent Burwell, ACPA, OK/AR Chapter, used with permission

Figure C.14. Existing concrete on 15th Street after milling the 3 in. thick asphalt overlay



Brent Burwell, ACPA, OK/AR Chapter, used with permission

Figure C.15. U-shaped No. 5 tied bars fastened over longitudinal cracks in the existing concrete



Brent Burwell, ACPA, OK/AR Chapter, used with permission

Figure C.16. Condition of 15th Street in September 2020

Appendix D

Staging Sequence Diagrams for Various Traffic Control Scenarios

Two-Lane Roadway with Paved Shoulders (Conventional Paver)	124
Two-Lane Roadway with Granular Shoulders (Conventional Paver)	126
Two-Lane Roadway with Minimum Granular Shoulders (Zero-Clearance Paver)	128
Two-Lane Roadway Widened to Three Lanes with Paved Shoulders (Conventional Paver)	130
Four-Lane Roadway with Paved Shoulders (Conventional Paver)	132

This appendix presents various staging sequence diagrams that illustrate different traffic control scenarios when constructing a concrete overlay without closing the road to traffic. The diagrams show the layout of the construction zone and the zone open to traffic and discuss the critical steps through the progression of work.

Two-Lane Roadway with Paved Shoulders (Conventional Paver)

Applied to:

- Bonded concrete overlay of concrete pavements
- Bonded concrete overlay of asphalt pavements
- Bonded concrete overlay of composite pavements
- Unbonded concrete overlay of concrete pavements
- Unbonded concrete overlay of asphalt pavements
- Unbonded concrete overlay of composite pavements

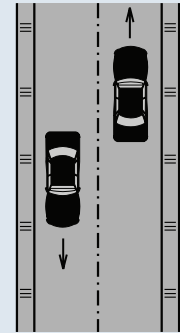

STAGE 1.

Repair surface, prepare for overlay, and construct base shoulder widening and separation layer

- Install traffic control and close the left lane. Follow jurisdictional requirements for traffic control. Check with jurisdiction regarding allowable lane closure length. If surface repair and preparation for the overlay are minimal, then slow-moving traffic control may be appropriate. Closing the lane may require additional traffic control (e.g., signals, flaggers, and/or pilot cars).
- Repair the surface as appropriate. Prepare the surface for the overlay (or, in the case of concrete overlay on concrete, the separation layer) as described in the contract document.
- Prepare for shoulder widening by trenching the existing shoulder and trimming to the specified width. The trench should be rolled and compacted as necessary to obtain a firm and stable platform as specified in the contract documents. A continuous progression approach with the shoulder trencher and placement of the base shoulder widening material is encouraged.
- Construct separation layer (only for unbonded overlay on concrete).

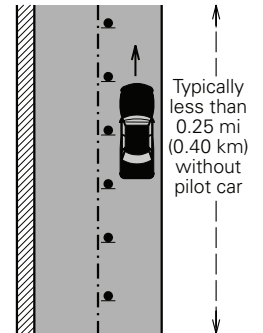

STAGE 2.

Construct right shoulder and concrete overlay

- Shift the traffic control to the left lane and close the right lane to traffic. The length of the closure will depend on the jurisdiction's maximum closure length with pilot car. Traffic controls and traffic control signals will be based on jurisdictional requirements.
- Repair and prepare the surface for the overlay or the separation layer and subsequent overlay as described in the contract documents. Construct separation layer (for unbonded overlay).
- Normal space for the paver stringline is 1–1.50 ft (0.30–0.46 m) and the paver track is a minimum of 2.50–3 ft (0.76–0.91 m). 1 ft (0.3 m) incremental encroachment reduction (up to 2 ft (0.6 m) total) is common through typical machine adjustment. Speeds should be additionally restricted adjacent to paver when clearance between the paver and vehicle traffic is tight.
- Construct concrete overlay on the existing pavement. Complete right PCC shoulder widening with the overlay. Bull float work shall operate from the outside shoulder only.
- The "X" dimension between the roadway centerline and vertical panel is for the paving machine track and stringline.

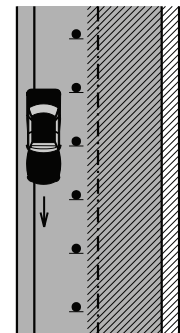

STAGE 3.

Construct left lane concrete overlay

- Close the opposite lane to traffic and place the concrete overlay according to contract documents, using the same procedures as described in stage 2. Note that stringline may not be necessary for the right edge of the paving when the paved overlay constructed in stage 2 is used as the paver control in this stage. If the right stringline is not used, the "X" dimension could possibly be reduced to 3 ft (0.9 m).
- If the outside edge dropoffs at the shoulder exceeds the jurisdictional allowance for a 1:1 fillet, then construct the granular shoulders in this stage.
- Complete shouldering. Install (mill) rumble strips in the paved shoulders and complete pavement marking and regulatory signing in accordance with contract documents.

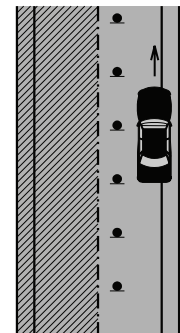

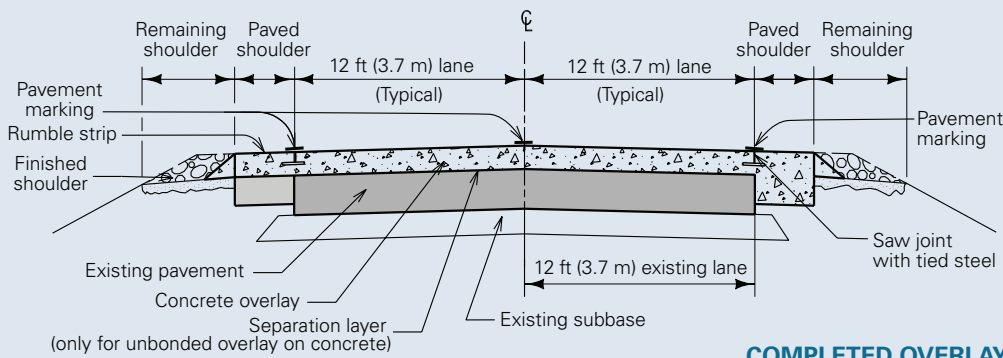

COMPLETED OVERLAY

LEGEND

- Stage work area
- Concrete
- Base shoulder widening materials (e.g., cement-treated base, porous concrete, roller compacted concrete (RCC), asphalt, or concrete)
- Granular material

NOTES:

- ① Follow jurisdictional requirements for traffic control devices.
- ② Treat 3 ft (0.9 m) area outside of proposed paved shoulder with calcium chloride. If the existing shoulder outside the proposed paved shoulder is less than 3 ft (0.9 m), it may be necessary to adjust the slipform paver and/or paver control to accommodate the reduced space.
- ③ Minimum lane width next to the paver may be reduced for short-term, stationary work on low-volume, low-speed roadways when vehicular traffic does not include longer and wider heavy commercial vehicles.
- ④ If the overlay is opened to traffic in this stage, and final shoulder backfill is delayed, place fillet as shown or (if overlay creates a dropoff greater than jurisdictional allowance) place granular shoulder.
- ⑤ See Figure 7.16.
- ⑥ For "X" less than 4 ft (1.2 m), adjustments to paver may be necessary to accommodate paver control and paver track.
- ⑦ The "X" dimension can be reduced to 3 ft (0.9 m) minimum when the right lane is used as paver control.
- ⑧ Mark edgelines and centerlines per MUTCD (FHWA 2009) section 6F.77 (mark both lanes).
- ⑨ Construct longitudinal joint.

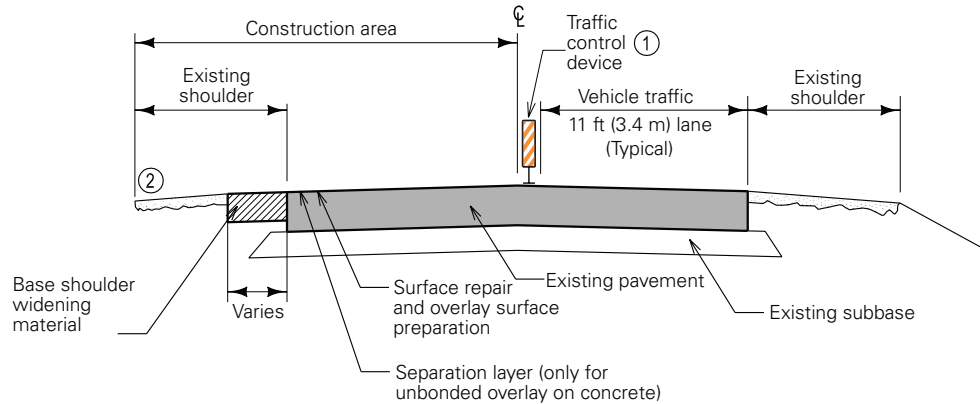

STAGE 1

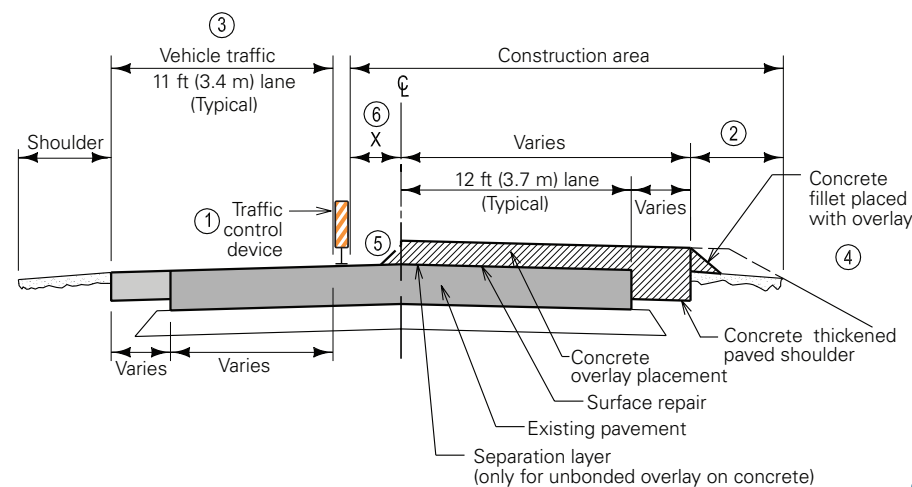

STAGE 2

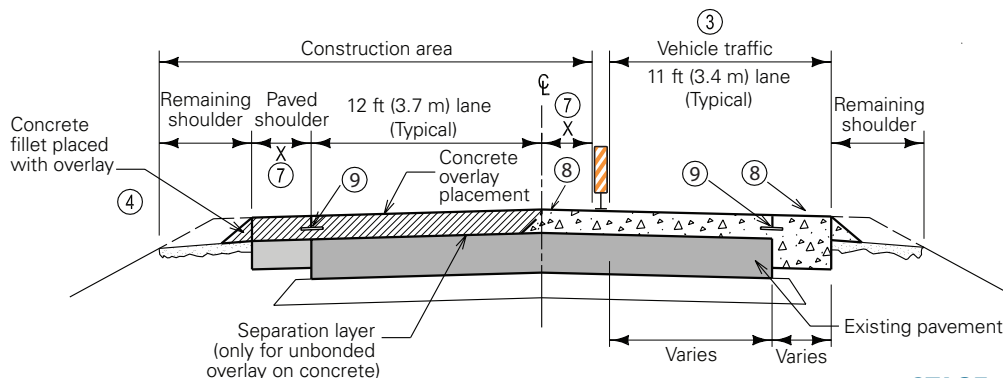

STAGE 3

Drawings: Snyder & Associates, Inc., used with permission

Two-Lane Roadway with Granular Shoulders (Conventional Paver)

Applied to:

- Bonded concrete overlay of concrete pavements
- Unbonded concrete overlay of concrete pavements
- Bonded concrete overlay of asphalt pavements
- Unbonded concrete overlay of asphalt pavements
- Bonded concrete overlay of composite pavements
- Unbonded concrete overlay of composite pavements

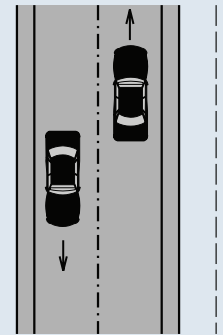

STAGE 1.

Repair surface, prepare for overlay, and construct left shoulder and separation layer

- Install traffic control and close the left lane. Follow jurisdictional requirements for traffic control. Check with jurisdiction regarding allowable lane closure length. If surface repair and preparation for the overlay are minimal, then slow-moving traffic control may be appropriate. Closing the lane may require additional traffic control (e.g., signals, flaggers, and/or pilot cars).
- Repair the surface as appropriate. Prepare the surface for the overlay (or, in the case of concrete overlay on concrete, the separation layer) as described in the contract document.
- Prepare shoulder widening by trenching the existing shoulder and trimming to the specified width. The trench should be rolled and compacted as necessary to obtain a firm and stable platform. Compact shoulder material as specified in the contract documents. A continuous progression approach with the shoulder trencher and placement of the base shoulder widening is encouraged.
- Construct calcium chloride treated granular shoulder as outlined in contract documents. The treated shoulder shall be firm and stable to support vehicular traffic at low speeds.
- Construct separation layer (only for unbonded overlay on concrete).

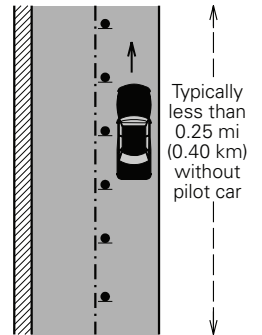

STAGE 2.

Construct right shoulder and concrete overlay

- Shift the traffic control to the left lane and close the right lane to traffic. The length of the closure will depend on the jurisdiction's maximum closure length with pilot car. Traffic controls and traffic control signals will be based on jurisdictional requirements.
- Repair and prepare the surface for the overlay or the separation layer and subsequent overlay as described in the contract documents. Construct separation layer (for unbonded overlay on concrete).
- Normal space for the paver stringline is 1–1.5 ft (0.3–0.5 m) and the paver track is a minimum of 2.5–3 ft (0.8–0.9 m). 1 ft (0.3 m) incremental encroachment reduction (up to 2 ft [0.6 m] total) is common through typical machine adjustment. Speeds should be restricted adjacent to paver when clearance between the paver and vehicle traffic is limited.
- Construct concrete overlay on the existing pavement. Construct right shoulder base with 6 in. (150 mm) thick granular shoulder. Bull float work shall operate from the outside shoulder only.
- Place 6 in. (150 mm) minimum thickness calcium chloride treated granular shoulder to help stabilize shoulder and minimize heavy dust that can impair vision.
- The "X" dimension between the roadway centerline and vertical panel is for the paving machine track and stringline.

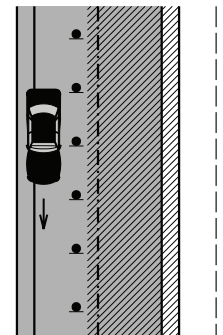

STAGE 3.

Construct left lane concrete overlay

- Close the opposite lane to traffic and place the concrete overlay according to contract documents, using the same procedures as described in stage 2. Stringline may not be necessary for the right edge of the paving when the paved overlay constructed in stage 2 is used as the paver control in this stage. If the right stringline is not used, the "X" dimension could possibly be reduced to 3 ft (0.9 m).
- If the outside edge dropoffs at the shoulder exceeds the jurisdictional allowance for a 1:1 fillet, then construct the granular shoulders in this stage.
- Complete shouldering. Complete pavement marking and regulatory signing in accordance with contract documents.

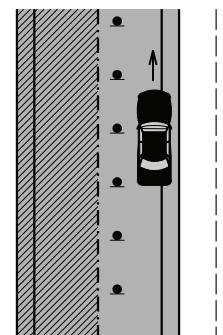

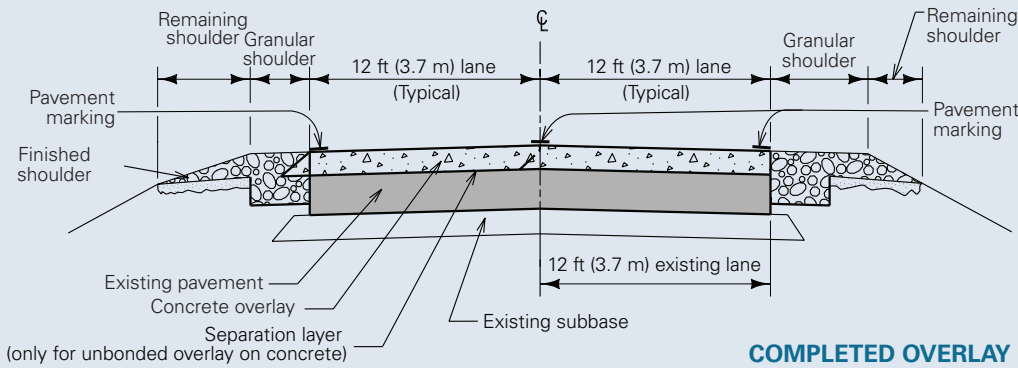

LEGEND

	Stage work area
	Concrete
	Granular material

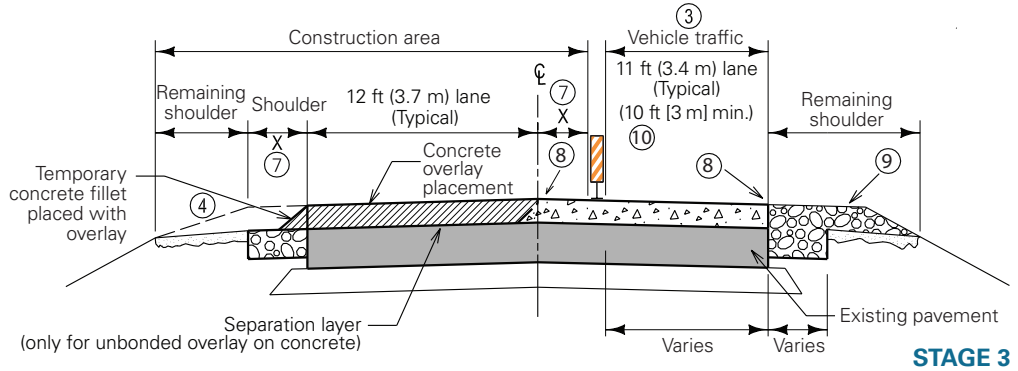
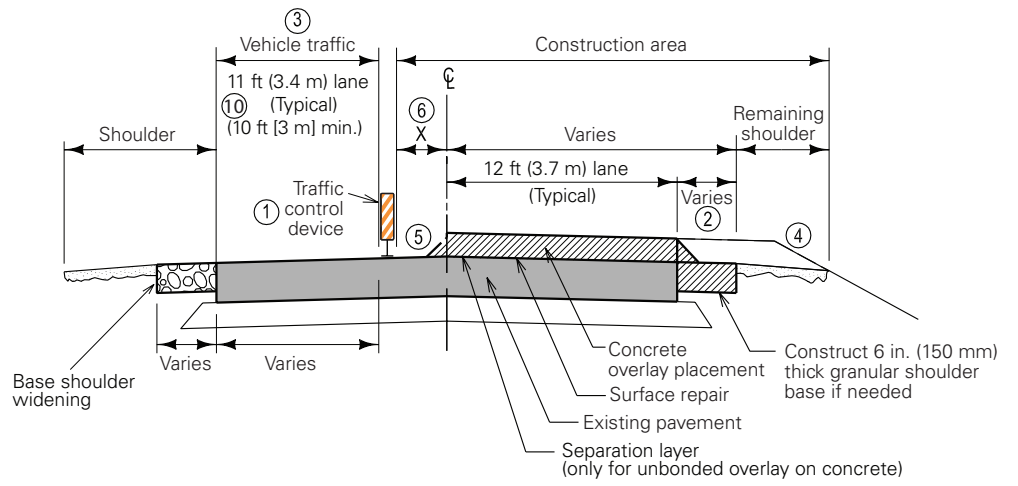
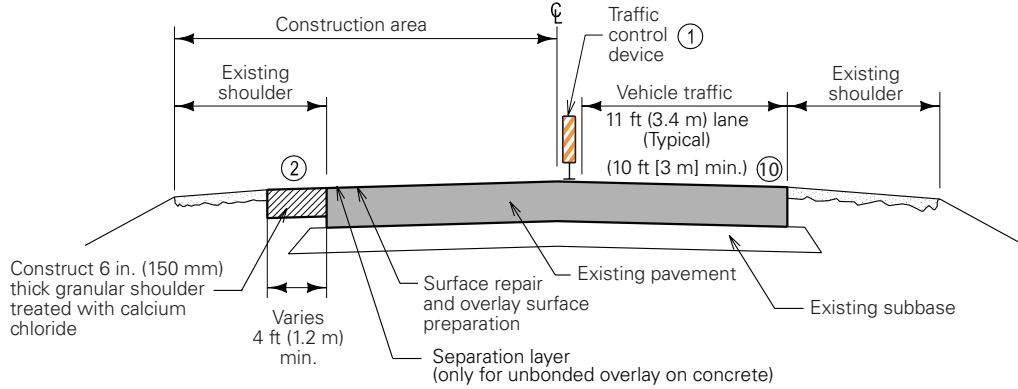

- NOTES:**
- Follow jurisdictional requirements for traffic control devices.
 - When the existing shoulder is less than 4 ft (1.2 m), adjustment to the slipform paver and/or paver control may be necessary to accommodate the reduced space for paver control and paver track.
 - Minimum lane width next to the paver may be reduced for short-term, stationary work on low-volume, low-speed roadways when vehicular traffic does not include longer and wider heavy commercial vehicles.
 - If the completed overlay in this stage opens to traffic and the final shoulder backfill is delayed, place fillet as shown. If overlay creates a dropoff greater than jurisdictional allowance, place granular shoulder in lieu of concrete fillet.
 - See Figure 7.16.
 - For "X" less than 4 ft (1.2 m), adjustments to paver may be necessary to accommodate paver control and paver track.
 - The "X" dimension can be reduced to 3 ft (0.9 m) minimum when the right lane is used as paver control.
 - Mark edgelines and centerlines per MUTCD (FHWA 2009) section 6F.77 (mark both lanes).
 - Use calcium chloride for dust control.
 - For low-volume roads only

Drawings: Snyder & Associates, Inc., used with permission

Two-Lane Roadway with Minimum Granular Shoulders (Zero-Clearance Paver)

Applied to:

- Bonded concrete overlay of concrete pavements
- Bonded concrete overlay of asphalt pavements
- Bonded concrete overlay of composite pavements
- Unbonded concrete overlay of concrete pavements
- Unbonded concrete overlay of asphalt pavements
- Unbonded concrete overlay of composite pavements

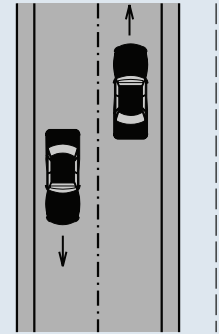

STAGE 1.

Repair surface, prepare for overlay, and construct left shoulder

- In order to construct an overlay on a roadway with a minimum of 2 ft (0.6 m) wide existing shoulders, adjustments to typical slipform pavers are necessary in order to meet existing clearances adjacent to the paver. The width of the clearance zone is dependent on traffic control, paver track, and paver control (stringline). When there is not enough clearance for the paver track, paving molds may be installed on typical two-track pavers to provide zero clearances. The outside edges of the mold are brought out behind the rear tracks and then the material from the front of the paver is moved to the back by an auger to be spread and paved.
- Install traffic control and close the left lane. Follow jurisdictional requirements for traffic control. Check

with jurisdiction regarding allowable lane closure length. If surface repair and preparation for the overlay are minimal, then slow-moving traffic control may be appropriate. Closing the lane may require additional traffic control (e.g., signals, flaggers, and/or pilot cars).

- Repair the surface as appropriate. Prepare the surface for the overlay (or, in the case of concrete overlay on concrete, the separation layer) as described in the contract document.
- Construct calcium chloride treated granular shoulder as outlined in contract documents. The treated shoulder shall be firm and stable to support vehicular traffic at low speeds.
- Construct separation layer (only for unbonded overlay on concrete).

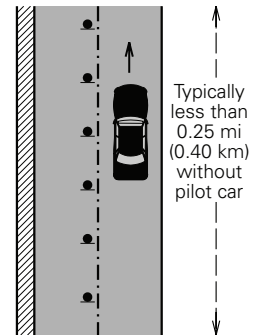

STAGE 2.

Construct right shoulder and concrete overlay

- Shift the traffic control to the left lane and close the right lane to traffic. The length of the closure will depend on the jurisdiction's maximum closure length with pilot car. Traffic controls and traffic control signals will be based on jurisdictional requirements.
- Repair and prepare the surface for the overlay or the separation layer and subsequent overlay as described in the contract documents. Construct separation layer (for unbonded overlay).
- Normal space for the paver stringline is 1–1.5 ft (0.3–0.5 m) and the paver track is a minimum of 2.5–3 ft (0.8–0.9 m). 1 ft (0.3 m) incremental encroachment reduction (up to 2 ft [0.6 m] total) is common through typical machine adjustment. Modification to a conventional paver is

necessary to achieve these dimensions. Speeds should be restricted adjacent to paver when clearance between the paver and vehicle traffic is limited.

- Construct concrete overlay on the existing pavement. Bull float work shall operate from the outside shoulder only.
- Place 6 in. (150 mm) minimum thickness calcium chloride treated granular shoulder to help stabilize shoulder and minimize heavy dust that can impair vision.
- The 1.5 ft (0.5 m) dimension between the roadway centerline and vertical panel is for the stringline and fillet.

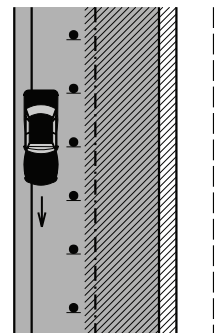

STAGE 3.

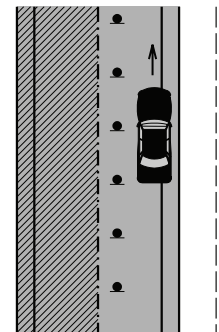

Construct left lane concrete overlay

- Close the opposite lane to traffic and place the concrete overlay according to contract documents, using the same procedures as described in stage 2.
- Complete shouldering. Complete pavement marking and regulatory signing in accordance with contract documents.

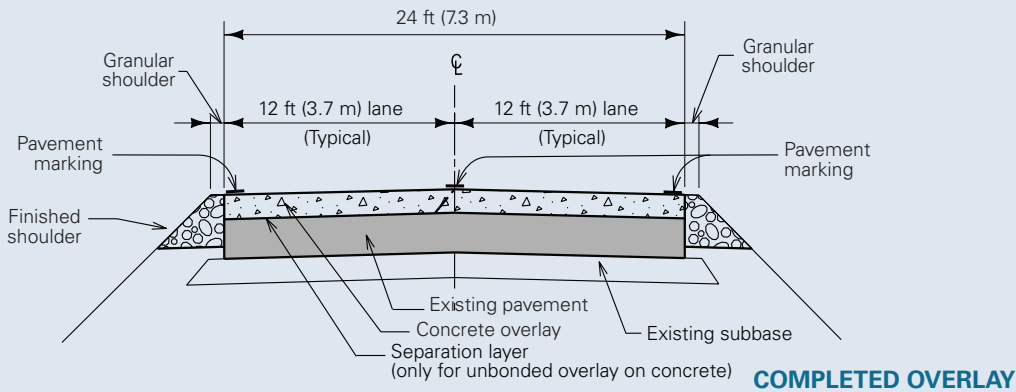



LEGEND

-  Stage work area
-  Concrete
-  Granular material

NOTES:

- ① Follow jurisdictional requirements for traffic control devices. Outside shoulder traffic control may depend on width of shoulder.
- ② Existing shoulder should have minimum 6 in. (150 mm) of granular material and should be treated with calcium chloride.
- ③ Minimum lane width next to the paver may be reduced for short-term, stationary work on low-volume, low-speed roadways when vehicular traffic does not include longer and wider heavy commercial vehicles.
- ④ Place granular shoulder with calcium chloride in two lifts. The first lift is for the paver track. The second lift is for final shoulder. If the completed overlay in this stage opens to traffic and the final lift is delayed, place concrete fillet as shown. If overlay creates a dropoff greater than jurisdictional allowance, place second lift before opening overlay to traffic.
- ⑤ See Figure 7.16.
- ⑥ Requires minimum to zero clearance paver. 1.5 ft (0.5 m) dimension is for the paver ski or stringline.
- ⑦ Mark edgelines and centerlines per MUTCD (FHWA 2009) section 6F.77 (mark both lanes).
- ⑧ For low-volume roads only

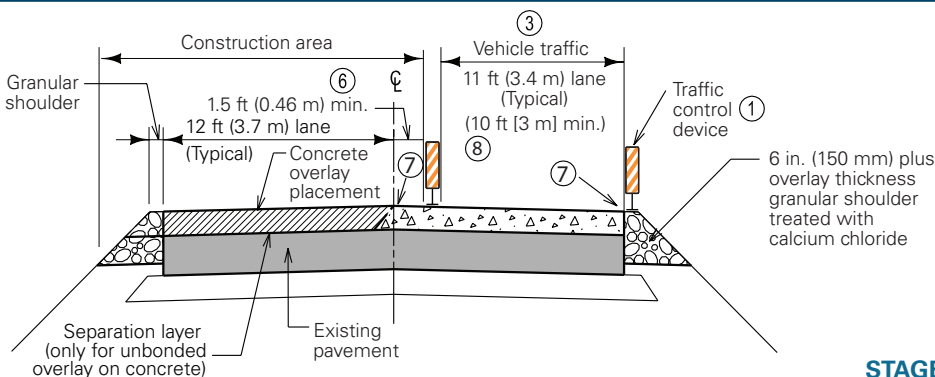
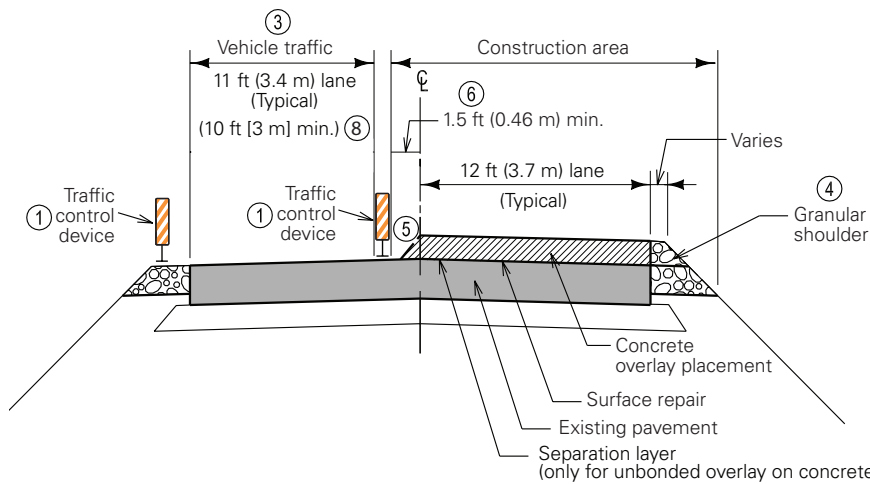
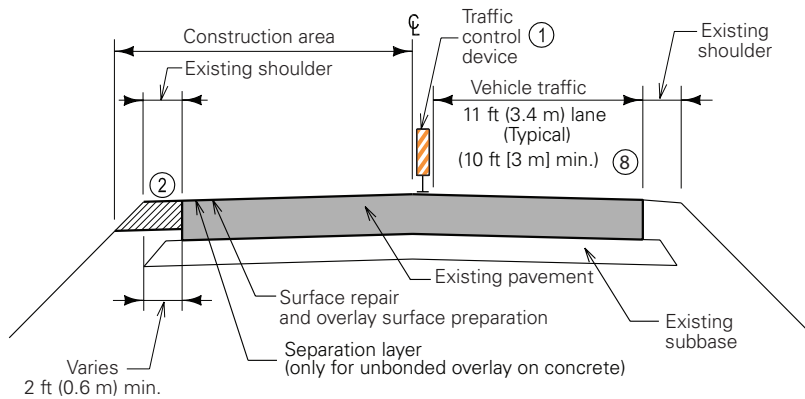

Drawings: Snyder & Associates, Inc., used with permission

Two-Lane Roadway Widened to Three Lanes with Paved Shoulders (Conventional Paver)

Applied to:

- Bonded concrete overlay of concrete pavements
- Unbonded concrete overlay of concrete pavements
- Bonded concrete overlay of asphalt pavements
- Unbonded concrete overlay of asphalt pavements
- Bonded concrete overlay of composite pavements
- Unbonded concrete overlay of composite pavements

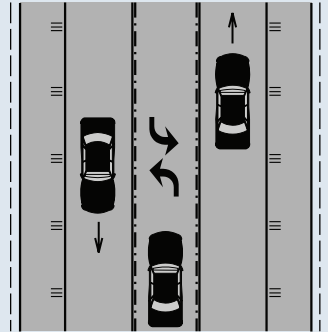

STAGE 1.

Repair surface, prepare for overlay, and construct base shoulder widening and separation layer

- Install traffic control and close the left lane. Follow jurisdictional requirements for traffic control. Check with jurisdiction regarding allowable lane closure length. If surface repair and preparation for the overlay are minimal, then slow-moving traffic control may be appropriate. Closing the lane may require additional traffic control (e.g., signals, flaggers, and/or pilot cars).
- Repair the surface as appropriate. Prepare the surface for the overlay (or, in the case of concrete overlay on concrete, the separation layer) as described in the contract document.
- Prepare shoulder widening by trenching the existing shoulder and trimming to the specified width. The trench should be rolled and compacted as necessary to obtain a firm and stable platform. Compact shoulder material as specified in the contract documents. A continuous progression approach with the shoulder trencher and placement of the base shoulder widening is encouraged.
- Pave the existing shoulder a minimum of 6 ft (1.8 m) with concrete.
- Use excavated granular material to widen existing shoulder. Treat 3 ft (0.9 m) area of shoulder with calcium chloride.
- Construct separation layer (only for unbonded overlay on concrete).

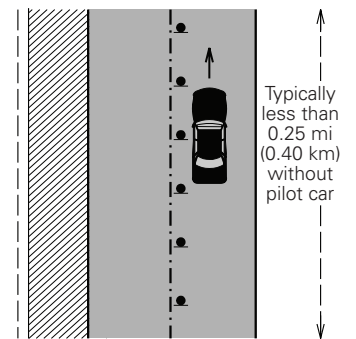

STAGE 2.

Construct thickened shoulder and concrete overlay

- Shift the traffic control to the left lane and close the right lane to traffic. The length of the closure will depend on the jurisdiction's maximum closure length with pilot car. Traffic controls and traffic control signals will be based on jurisdictional requirements.
- Repair and prepare the surface for the overlay or the separation layer and subsequent overlay as described in the contract documents. Construct separation layer (for unbonded overlay).
- Construct concrete overlay on the existing pavement. Complete right PCC shoulder widening with the overlay.
- The "X" dimension between the roadway centerline and vertical panel is for the paving machine track and stringline.

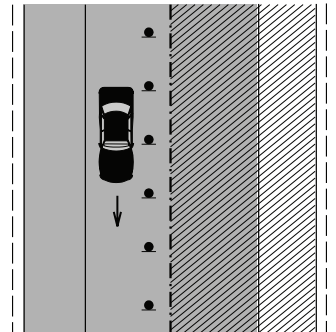

STAGE 3.

Construct left lane concrete overlay

- Close the opposite lane to traffic and place the concrete overlay according to contract documents, using the same procedures as described in stage 2. Stringline may not be necessary for the right edge of the paving when the paved overlay constructed in stage 2 is used as the paver control in this stage.
- If the outside edge dropoffs at the shoulder exceeds the jurisdictional allowance for a 1:1 fillet, then construct the granular shoulders in this stage.
- Complete shoulders. Install (mill) rumble strips in the paved shoulders and complete pavement marking and regulatory signing in accordance with contract documents.

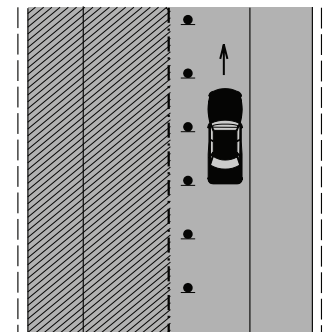

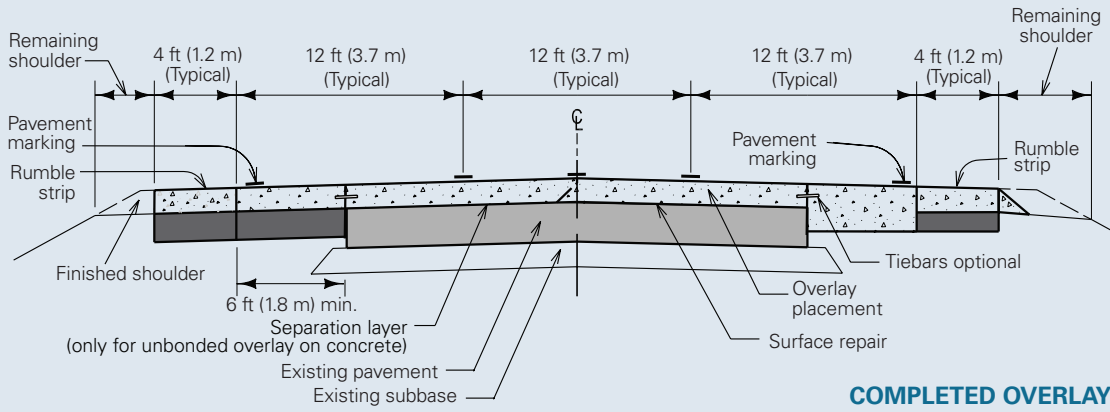

COMPLETED OVERLAY

LEGEND

- Stage work area
- Concrete
- Base shoulder widening materials (e.g., cement-treated base, porous concrete, roller compacted concrete (RCC), asphalt, or concrete)
- Granular material

NOTES:

- ① Follow jurisdictional requirements for traffic control devices.
- ② Use excavated granular material to widen existing shoulder. Treat 3 ft (0.9 m) area of shoulder with calcium chloride.
- ③ Minimum lane width next to the paver may be reduced for short-term, stationary work on low-volume, low-speed roadways when vehicular traffic does not include longer and wider heavy commercial vehicles.
- ④ If the completed overlay in this stage opens to traffic and the final shoulder back fill is delayed, place fillet as shown. If overlay creates a dropoff greater than jurisdictional allowance, place second lift before opening overlay to traffic.
- ⑤ See Figure 7.16.
- ⑥ Mark edgelines and centerlines per MUTCD (FHWA 2009) section 6F.77 (mark both lanes).

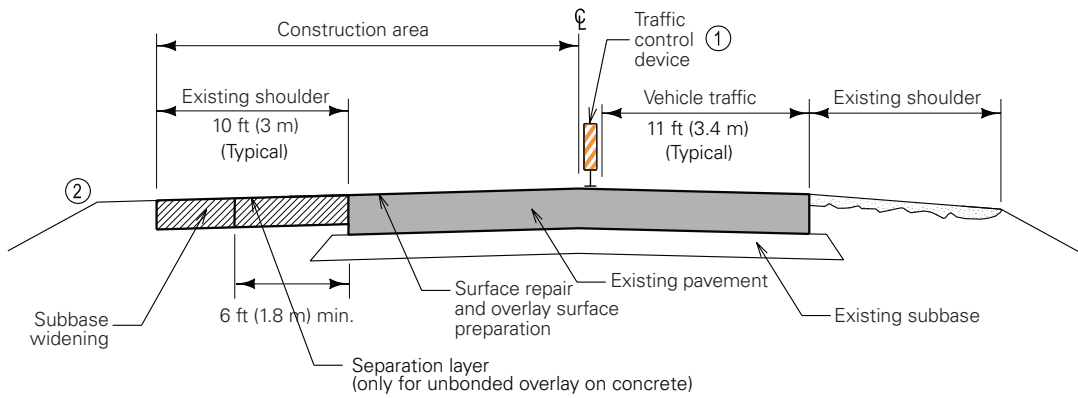

STAGE 1

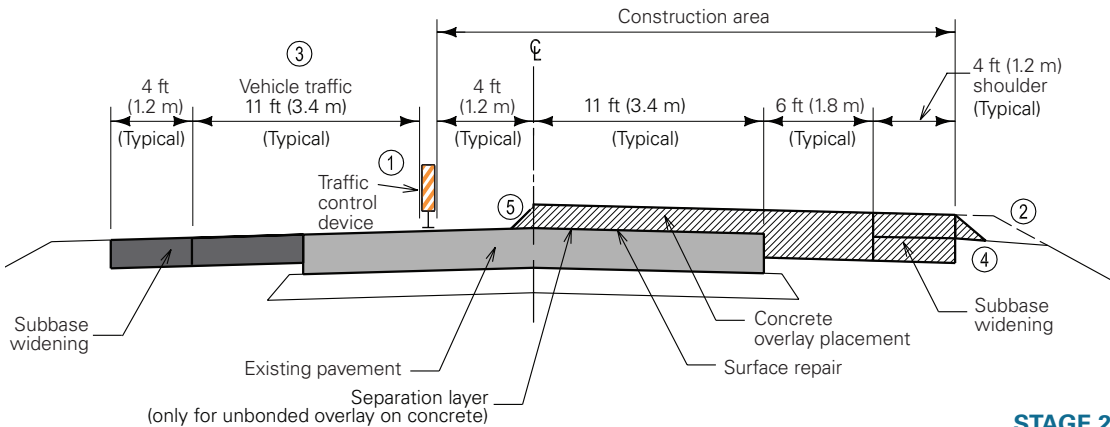

STAGE 2

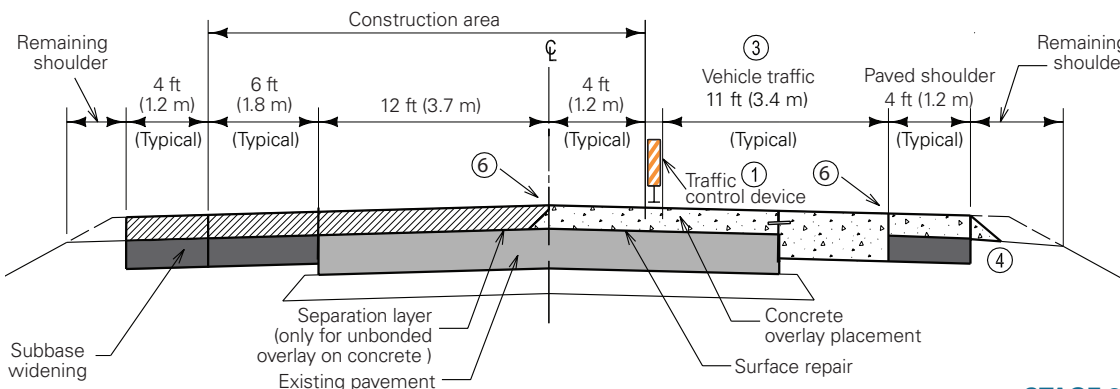

STAGE 3

Drawings: Snyder & Associates, Inc., used with permission

Four-Lane Roadway with Paved Shoulders (Conventional Paver)

Applied to:

- Bonded concrete overlay of concrete pavements
- Unbonded concrete overlay of concrete pavements
- Bonded concrete overlay of asphalt pavements
- Unbonded concrete overlay of asphalt pavements
- Bonded concrete overlay of composite pavements
- Unbonded concrete overlay of composite pavements

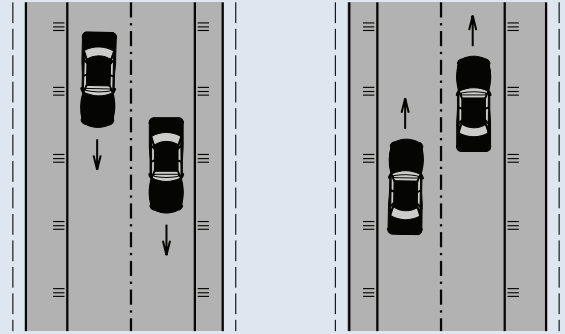

STAGE 1. Repair surface and prepare for overlay

- Install traffic control and close the inside lanes. Follow jurisdictional requirements for traffic control. Check with jurisdiction regarding allowable lane closure length. If surface repair and preparation for the overlay are minimal, then slow-moving traffic control may be appropriate. Closing the lanes may require additional traffic control (e.g., signals and flaggers).
- Repair the surface as appropriate. Prepare the surface for the overlay (or, in the case of concrete overlay on concrete, the separation layer) as described in the contract document.
- Evaluate the structural condition of the existing shoulder. Mill existing shoulder or reconstruct shoulder to carry traffic load if necessary.
- Construct separation layer (only for unbonded overlay on concrete).

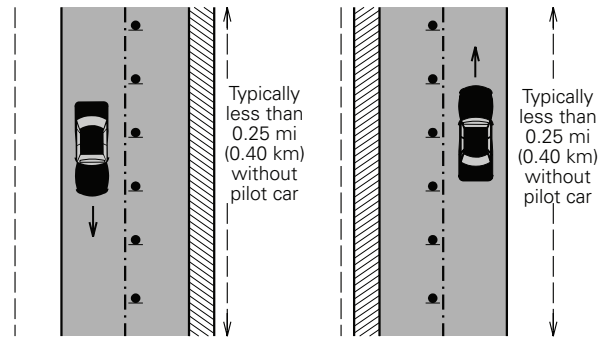

STAGE 2. Construct concrete overlay on outside lane

- Shift the traffic control to the inside lanes and close the outside lanes to traffic. Traffic controls and traffic control signals will be based on jurisdictional requirements.
- Repair and prepare the surface for the overlay or the separation layer and subsequent overlay as described in the contract documents. Construct separation layer (for unbonded overlay).
- Construct temporary shoulder for paver track.
- Construct concrete overlay on the existing pavement. Bull float work shall operate from the outside shoulder only.

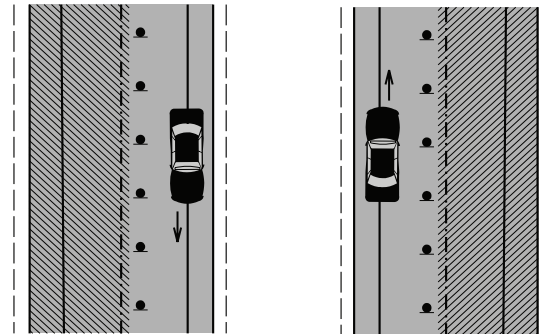



STAGE 3. Construct concrete overlay on inside lane

- Shift the traffic control to the outside lane and close the inside lane to traffic. Place the concrete overlay according to contract documents, using the same procedures as described in stage 2. Stringline may not be necessary for the right edge of the paving when the paved overlay constructed in stage 2 is used as the paver control in this stage.
- Complete shoulder finish grading. Install (mill) rumble strips in the paved shoulders and complete pavement marking and regulatory signing in accordance with contract documents.

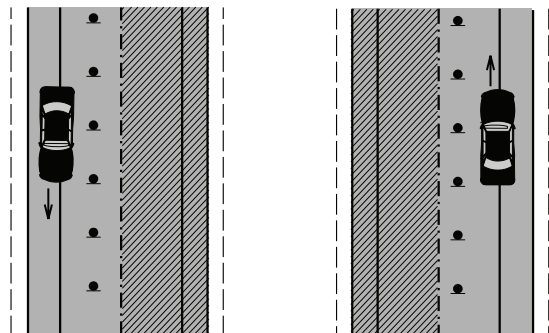
If the right stringline is not used, the "X" dimension could possibly be reduced to 3 ft (0.9 m).



LEGEND

-  Stage work area
-  Concrete
-  Existing shoulder (Reconstructed if necessary)

NOTES:

- ① Follow jurisdictional requirements for traffic control devices.
- ② Evaluate the structural condition of the existing shoulder. If necessary, reconstruct shoulder with PCC or asphalt to carry the traffic load.
- ③ See Figure 7.16.
- ④ When the existing shoulder outside of the proposed paved shoulder is less than 3 ft (0.9 m), adjustment to the paver may be necessary to accommodate paver control and paver track.
- ⑤ If the completed overlay in this stage opens to traffic and the final shoulder backfill is delayed, place fillet as shown. If overlay creates a dropoff greater than jurisdictional allowance, place second lift before opening overlay to traffic.
- ⑥ For "X" less than 4 ft (1.2 m), adjustments to paver may be necessary to accommodate paver control and paver track.
- ⑦ The "X" dimension can be reduced to 3 ft (0.9 m) minimum when the right lane is used as paver control.
- ⑧ Mark edgelines and centerlines per MUTCD (FHWA 2009) section 6F.77 (mark both lanes).

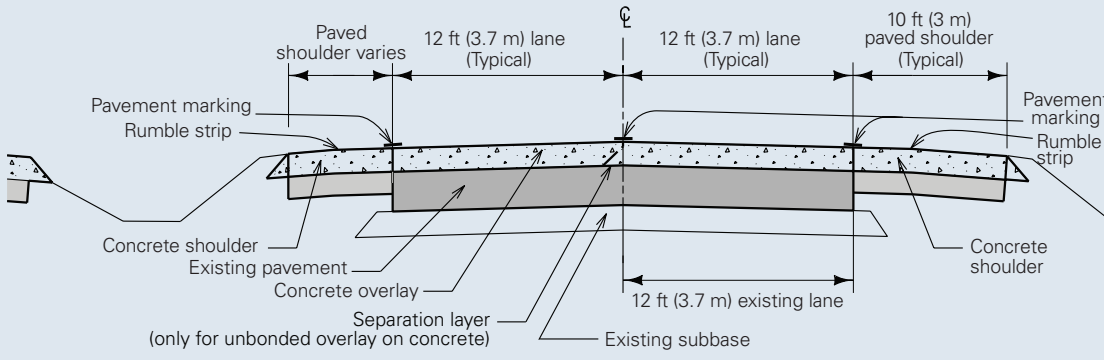

COMPLETED OVERLAY

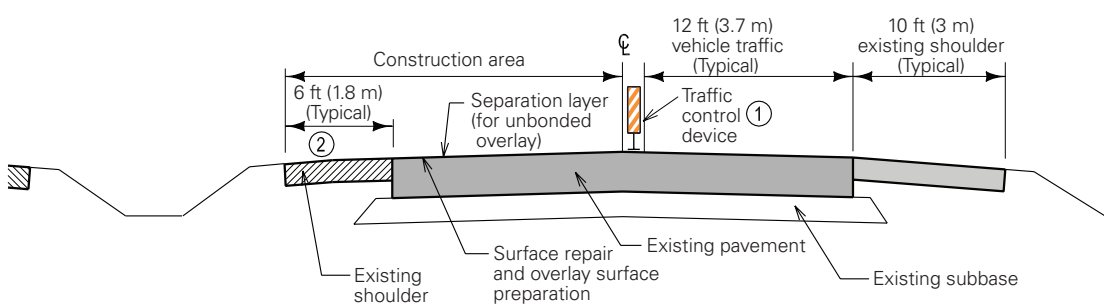

STAGE 1

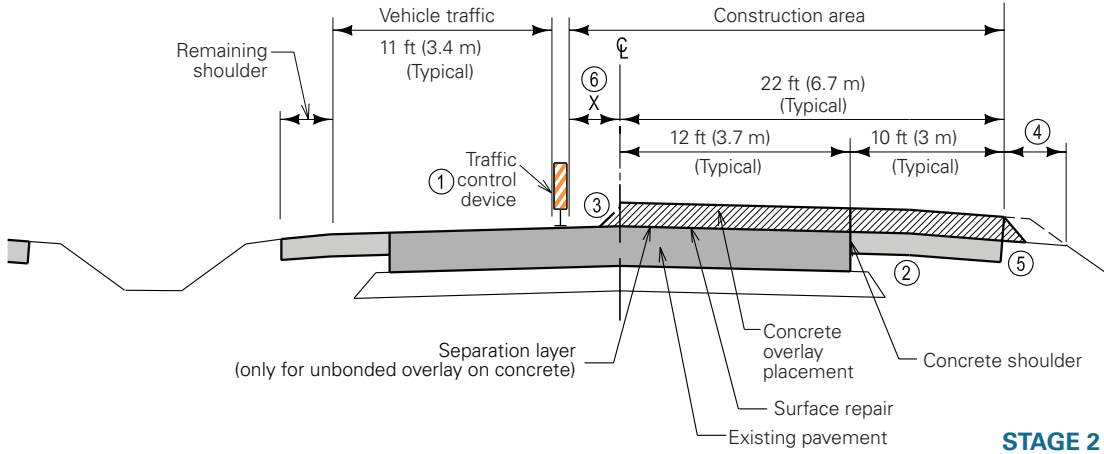

STAGE 2

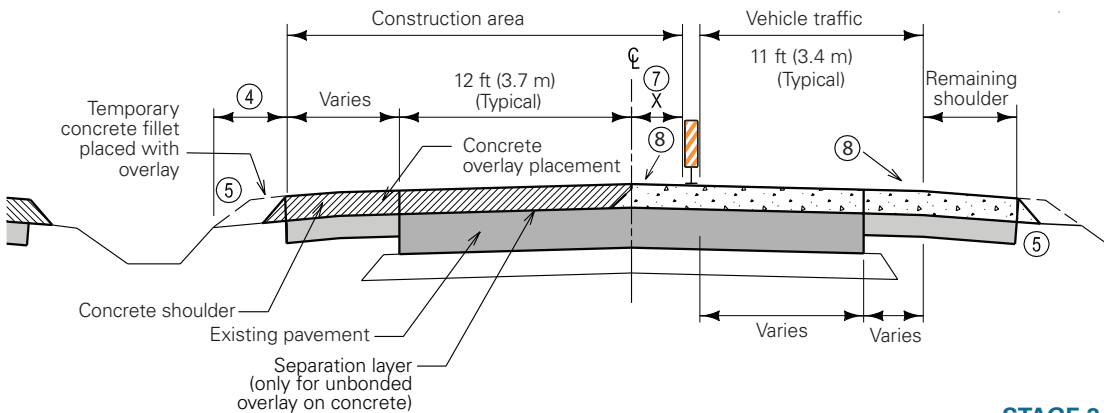

STAGE 3

Drawings: Snyder & Associates, Inc., used with permission

References

- AASHTO. 1993. *AASHTO Guide for the Design of Pavement Structures*. American Association of State Highway and Transportation Officials, Washington, DC.
- AASHTO. 2020. *Mechanistic-Empirical Pavement Design Guide: A Manual of Practice*. 3rd Edition. American Association of State Highway and Transportation Officials, Washington, DC.
- ACI Committee 201. 2016. *Guide to Durable Concrete*. ACI 201.2R-16. American Concrete Institute, Farmington Hills, MI. <https://www.concrete.org/publications/internationalconcreteabstractsportal/m/details/id/51689514>.
- ACPA. 1992. *Design and Construction of Joints for Concrete Streets*. IS061.01P. American Concrete Pavement Association, Skokie, IL. <https://nwcement.org/wp-content/uploads/2018/03/Design-and-Construction-of-Joints-for-Concrete-Streets-IS061.01P.pdf>.
- ACPA. 2007. *Intersection Joint Layout*. IS006.02P. American Concrete Pavement Association, Skokie, IL. http://wwwsp.dotd.la.gov/Inside_LaDOTD/Divisions/Engineering/Road_Design/Road%20Design%20Manual/Appendix/ACPA%20Intersection%20Joint%20Layout.pdf.
- ACPA. 2010. *Concrete Pavement Field Reference: Paving*. EB238. American Concrete Pavement Association, Rosemont, IL. <https://www.longerlifepavement.com/wp-content/uploads/2017/06/EB238P-Concrete-Pavement-Field-Reference-Paving.pdf>.
- ACPA. 2018. *Concrete Pavement Joint Sealing/Filling*. Technical Bulletin TB010-2018. American Concrete Pavement Association, Rosemont, IL. <https://pavewise.com/wp-content/uploads/2021/01/Joining-Sealing-Tech-Bulletin-TB010-2018.pdf>.
- ACPA. 2021. National Concrete Overlay Explorer. American Concrete Pavement Association, Rosemont, IL. <http://overlays.acpa.org/webapps/overlayexplorer/index.html>.
- Alberola, R. 1997. A Continuous Reinforced Concrete Pavement (CRCP) Overlay for the Torrejon Bypass. 6th International Purdue Conference on Concrete Pavement Design and Materials for High Performance, November 18–21, 1997, Indianapolis, IN. pp. 257–275.
- Alland, K., J. M. Vandenbossche, J. DeSantis, M. B. Snyder, and L. Khazanovich. 2018. Comparing the BCOA-ME Design Procedure and the Short-Jointed Plain Concrete Pavement Module in the Pavement ME Design Procedure. 97th Annual Meeting of the Transportation Research Board, January 7–11, 2018, Washington, DC.
- Barman, M., and B. Hansen. 2018. *Comparison of Performances of Structural Fibers and Development of a Specification for Using Them in Thin Concrete Overlays*. Minnesota Department of Transportation, St. Paul, MN. <http://www.dot.state.mn.us/research/reports/2018/201829.pdf>.
- Barman, M., J. M. Vandenbossche, and Z. Li. 2015. Characterization of Load Transfer Behavior for Bonded Concrete Overlays on Asphalt. *Transportation Research Record: Journal of the Transportation Research Board*, Vol. 2524, pp. 143–151.
- Betterton, R. M., M. J. Knutson, and V. J. Marks. 1984. *A Ten-Year Performance Summary of Fibrous PC Concrete Overlay Research in Greene County, Iowa*. Iowa Department of Transportation, Ames, IA. http://publications.iowa.gov/19639/1/IADOT_hr165_Ten_Year_Performance_Summary_Fibrous_PC_Concrete_1984.pdf.
- Bhattacharya, B., A. Gotlif, and M. Darter. 2017. Implementation of the Thin Bonded Concrete Overlay of Existing Asphalt Pavement Design Procedure in the AASHTOWare Pavement ME Design Software. 96th Annual Meeting of the Transportation Research Board, January 8–12, 2018, Washington, DC.

- Brand, A., and J. Roesler. 2014. Finite Element Analysis of a Concrete Slab under Various Nonuniform Support Conditions. *International Journal of Pavement Engineering*, Vol. 15, No. 5, pp. 460–470.
- Brink, A. C., and K. Pickard. 2008. CRCP on the Ben Schoeman Freeway – No Alternative. Ninth International Conference on Concrete Pavements, August 17–21, 2008, San Francisco, CA. pp. 54–69.
- Brink, A. C., D. Rossmann, and S. Skorpen. 2006. Continuously Reinforced Concrete Inlay at Townhill Compulsory Truck Stop. 10th International Symposium on Concrete Roads, September 18–22, 2006, Brussels, Belgium.
- Burnham, T. 2012. Impact of Sealed Joints on Performance of Thin Whitetopping at MnROAD. 91st Annual Meeting of the Transportation Research Board, January 22–26, 2012, Washington, DC. <https://www.sealnoseal.org/PDF/TRBmnRoad/BurnhamP125074.pdf>.
- Cable, J. 1995. *Bond Development in Concrete Overlays*. College of Engineering, Iowa State University, Ames, IA. <http://publications.iowa.gov/11670/1/hr561.pdf>.
- Cackler, T. 2017. *Performance Assessment of Nonwoven Geotextile Materials Used as Separation Layer for Unbonded Concrete Overlay of Existing Concrete Pavement Applications in the US*. MAP Brief. National Concrete Pavement Technology Center, Ames, IA. <https://intrans.iastate.edu/app/uploads/2018/10/MAPbriefDec2017.pdf>.
- Cackler, T., D. Harrington, and P. Taylor. 2017. *Performance-Engineered Mixtures (PEM) for Concrete Pavements*. MAP Brief. National Concrete Pavement Technology Center, Ames, IA. <https://intrans.iastate.edu/app/uploads/2019/11/MAPbriefApril2017.pdf>.
- Cavalline, T. L., G. J. Fick, and A. Innis. 2021. *Quality Control for Concrete Paving: A Tool for Agency and Industry*. National Concrete Pavement Technology Center, Ames, IA.
- CDOT. 2021. *Colorado Procedure (CP) 79-20 – Standard Practice for Evaluating MIT Scan Images for Uncut Dowel Baskets*. Colorado Department of Transportation, Denver, CO. <https://www.codot.gov/business/designsupport/materials-and-geotechnical/manuals/2021-fmm/cps/CP-70s/31-cp-79-21>.
- Chen, D. H., and F. Hong. 2014. Bonded continuously reinforced concrete overlay on jointed concrete pavement. *Canadian Journal of Civil Engineering*, Vol. 41, No. 5, pp. 432–439.
- Chen, D. H., M. Won, X. Chen, and W. Zhou. 2016. Design improvements to enhance the performance of thin and ultra-thin concrete overlays in Texas. *Construction and Building Materials*, Vol. 116, pp. 1–14.
- Choi, P., H. Won, F. Yu, and M. Won. 2018. *Proper Overlay Type and Designs for PCC Pavement*. FHWA/TX-18-0-6910-R1. Center for Multidisciplinary Research in Transportation, Texas Tech University, Lubbock, TX. <https://library.ctr.utexas.edu/hostedpdfs/texastech/0-6910-1.pdf>.
- CP Tech Center. 2019. Residual Strength Estimator. National Concrete Pavement Technology Center, Ames, IA. https://intrans.iastate.edu/app/uploads/2019/03/Residual-Strength-Estimator-for-FRC-Overlays-April-19-2019_public.xlsx.
- Crawley, A. B., and J. P. Sheffield. 1983. Continuously reinforced concrete overlay of existing continuously reinforced concrete pavement. *Transportation Research Record: Journal of the Transportation Research Board*, Vol. 924, pp. 1–9.
- CRSI. 1973. *Continuously Reinforced Concrete Overlays: Design and Construction*. Concrete Reinforcing Steel Institute, Chicago, IL.
- CRSI. 1988. *Performance of CRC Overlays: A Study of Continuously Reinforced Concrete Resurfacing Projects in Four States*. Concrete Reinforcing Steel Institute, Schaumburg, IL.
- CRSI. 2003. *CRCP in Georgia, Case History Report No. 61*. Concrete Reinforcing Steel Institute, Schaumburg, IL.
- Darter, M. I., and E. J. Barenberg. 1980. *Bonded concrete overlays: Construction and performance*. Miscellaneous Paper GL-80-11. U.S. Army Engineer Waterways Experiment Station, Vicksburg, MS. <http://hdl.handle.net/11681/10146>.
- Debroux, R., and A. Jasienski. 2008. RN61 – Mons – Tournai Road – Bury Braffe Section: A modest renovation becoming a long life pavement. Ninth International Conference on Concrete Pavements, August 17–21, 2008, San Francisco, CA. pp. 70–78.
- Delatte, Jr., N. J., D. W. Fowler, B. F. McCullough, and S. F. Gräter. 1998. Investigating performance of bonded concrete overlays. *Journal of Performance of Constructed Facilities*, Vol. 12, No. 2, pp. 62–70.

- Ferrebee, E., A. Gierltowski, and G. Voigt. 2018. Creation and Development of PavementDesigner.org: A Unified Industry-wide Pavement Design Tool for Concrete and Cement-based Solutions. 13th International Symposium on Concrete Roads, June 19–22, 2018, Berlin, Germany.
- Ferrebee, E., and J. Roesler. 2018. Regionalized Life-Cycle Assessment Tool for Evaluating Concrete Pavement Alternatives. 13th International Symposium on Concrete Roads, June 19–22, 2018, Berlin, Germany.
- FHWA. 1993. *Report on the 1992 US Tour of European Concrete Highways*. FHWA-SA-93-012. Federal Highway Administration, Washington, DC.
- FHWA. 2009. *Manual on Uniform Traffic Control Devices for Streets and Highways*. 2009 Edition. Federal Highway Administration, Washington, DC.
- FHWA. 2018. Accelerated Construction. Federal Highway Administration, Washington, DC. <https://ops.fhwa.dot.gov/wz/construction/accelerated/index.htm>.
- FHWA. 2019. *Technical Advisory T 5040.30: Concrete Pavement Joints*. Federal Highway Administration, Washington, DC. <https://www.fhwa.dot.gov/pavement/ta504030.pdf>.
- Fick, G., P. Taylor, R. Christman, and J. M. Ruiz. 2012. *Field Reference Manual for Quality Concrete Pavements*. Federal Highway Administration, Washington, DC. <https://www.fhwa.dot.gov/pavement/concrete/pubs/hif13059.pdf>.
- Fick, G., and D. Harrington. 2016. *Guide Specifications for Concrete Overlays*. National Concrete Pavement Technology Center, Ames, IA. https://intrans.iastate.edu/app/uploads/2018/08/overlay_guide_specifications.pdf.
- Folkestad, A. 2019. *Survey of State Department of Transportation Discount Rates*. American Concrete Pavement Association, CO/WY Chapter, Centennial, CO.
- Freeseaman, K., K. Hoegh, and L. Khazanovich. 2016. *Concrete Strength Required to Open to Traffic*. University of Minnesota, Minneapolis, MN. <http://www.dot.state.mn.us/research/TS/2016/201601.pdf>.
- Gaspard, K., M. Martinez, Z. Zhang, and Z. Wu. 2007. *Impact of Hurricane Katrina on Roadways in the New Orleans Area*. Technical Assistance Report No. 07-2TA. Louisiana Transportation Research Center, Baton Rouge, LA. https://www.ltrc.lsu.edu/pdf/2007/07_2ta.pdf.
- Green, J., and I. Davies, I. 2000. A449 Coldra-Usk Rehabilitation. *Municipal Engineer*, Vol. 139, No. 1, pp. 13–20.
- Gregory, J. M. 1984. Continuously reinforced concrete pavements. *Proceedings of the Institution of Civil Engineers*, Vol. 76, No. 2, pp. 449–472.
- Gross, J. Forthcoming. *History of Concrete Overlays in the United States*. 2nd Edition. National Concrete Pavement Technology Center, Ames, IA.
- Gross, J., and D. Harrington. 2018. *Guide for the Development of Concrete Overlay Construction Documents*. National Concrete Pavement Technology Center, Ames, IA. https://intrans.iastate.edu/app/uploads/2018/09/overlay_construction_doc_dev_guide_w_cvr.pdf.
- Gross, J., D. King, H. Ceylan, Y. A. Chen, and P. Taylor. 2019. *Optimized Joint Spacing for Concrete Overlays with and without Structural Fiber Reinforcing*. National Concrete Pavement Technology Center, Ames, IA. https://intrans.iastate.edu/app/uploads/2019/06/optimized_joint_spacing_for_overlays_w_cvr.pdf.
- Gross, J., D. King, D. Harrington, H. Ceylan, Y. A. Chen, S. Kim, P. Taylor, and O. Kaya. 2017. *Concrete Overlay Performance on Iowa's Roadways*. Iowa Highway Research Board and Iowa Department of Transportation, Ames, IA. https://intrans.iastate.edu/app/uploads/2017/09/Iowa_concrete_overlay_performance_w_cvr.pdf.
- Harrington, D., M. Ayers, T. Cackler, G. Fick, D. Schwartz, K. Smith, M. B. Snyder, and T. Van Dam. 2018. *Guide for Concrete Pavement Distress Assessments and Solutions: Identification, Causes, Prevention, and Repair*. National Concrete Pavement Technology Center, Ames, IA. https://intrans.iastate.edu/app/uploads/2019/01/concrete_pvmt_distress_assessments_and_solutions_guide_w_cvr.pdf.
- Heckel, L. B. 2002. *Performance of an Unbonded Concrete Overlay on I-74*. Report No. IL-PRR-140. Illinois Department of Transportation, Springfield, IL. <https://idot.illinois.gov/Assets/uploads/files/Transportation-System/Research/Physical-Research-Reports/140.pdf>.
- Heckel, L. B., and C. J. Wienrank. 2018. Performance of Concrete Overlays on Illinois Interstates, 1967 through 2016. *Transportation Research Record: Journal of the Transportation Research Board*, Vol. 2672, No. 40. <https://journals.sagepub.com/doi/full/10.1177/0361198118781146?journalCode=trra>.

- IDOT. 2019. *Condition Rating Survey Summary Report: FY2019*. Illinois Department of Transportation, Springfield, IL. https://idot.illinois.gov/Assets/uploads/files/Transportation-System/Reports/OP&P/Travel-Stats/FY2019_CRS%20Summary%20Report.pdf.
- Jung, Y., D. G. Zollinger, and S. D. Tayabji. 2007. *Best Practices of Concrete Pavement Transition Design and Construction*. FHWA/TX-07/0-5320-1. Texas Department of Transportation, Austin, TX. <https://static.tti.tamu.edu/tti.tamu.edu/documents/0-5320-1.pdf>.
- Kannemeyer, L., B. Perrie, P. Strauss, and L. du Plessis. 2008. Ultra-Thin CRCP Development in South Africa. Ninth International Conference on Concrete Pavements, August 17–21, 2008, San Francisco, CA. pp. 995–1018.
- Khazanovich, L., and H. Li. 2019. *Evaluation of Long-Term Impacts of Early Opening of Concrete Pavements: Task 2 Evaluation of Early Loading Damage*. TPF-5(341). Minnesota Department of Transportation, St. Paul, MN. https://appriver3651017871-my.sharepoint.com/:w:/g/personal/mjzeller_cpamn_com/Ee9RrR8G4EdHlxgNAwU7B7sBeiEzIVK3ug4ehwwYGai6PA?rttime=05EMnzgW2Ug.
- Khazanovich, L., J. M. Vandebossche, J. DeSantis, and S. Sachs. 2020. *Development of an Improved Design Procedure for Unbonded Concrete Overlays*. Report No. MN 2020-08. Minnesota Department of Transportation. St. Paul, MN. <http://www.dot.state.mn.us/research/reports/2020/202008.pdf>.
- Kim, D., and M. Won. 2008. *Evaluation of Bonded Concrete Overlay on IH 610 in Houston, Texas*. FHWA/TX-08/0-4893-3. Texas Department of Transportation, Austin, TX. https://ctr.utexas.edu/wp-content/uploads/pubs/0_4893_3.pdf.
- King, D., and J. Roesler. 2014. *Structural Performance of Ultra-Thin Whitetopping on Illinois Roadways and Parking Lots*. Research Report No. FHWA-ICT-14-018. Illinois Center for Transportation, Urbana, IL. <https://www.ideals.illinois.edu/bitstream/handle/2142/50312/FHWA-ICT-14-018.pdf?sequence=2&isAllowed=y>.
- Leykauf, G., and D. Birmann. 2006. Concrete Pavements with Geotextile Interlayer in Germany: Measurements and Long-term Behavior. *Proceedings of the 10th International Symposium on Concrete Roads, Brussels, Belgium, September 18–22, 2006*. Federation of the Belgian Cement Industry, Brussels, Belgium.
- Lippert, D. L., and J. B. DuBose. 1988. *Performance Evaluation of Concrete Overlays*. Report FHWA/IL/PR-101. Illinois Department of Transportation, Springfield, IL. <https://idot.illinois.gov/Assets/uploads/files/Transportation-System/Research/Physical-Research-Reports/101.PDF>.
- Lokken, E. C. 1981. Concrete overlays for concrete and asphalt pavements. 2nd International Conference on Concrete Pavement Design, April 14–18, Indianapolis, IN. pp. 125–144.
- McGhee, K. M. 1994. *Synthesis of Highway Practice 204: Portland Cement Concrete Resurfacing*. National Cooperative Highway Research Program, Washington, DC. http://onlinepubs.trb.org/Onlinepubs/nchrp/nchrp_syn_204.pdf.
- McNeal, A. F. 1996. *Planning, Design and Construction of an Unbonded Concrete Overlay*. Report FHWA/IL/PR-122. Illinois Department of Transportation, Springfield, IL. <https://idot.illinois.gov/Assets/uploads/files/Transportation-System/Research/Physical-Research-Reports/122.PDF>.
- Metcalf, P., and R. Dudgeon. 2004. The Use of Continuously Reinforced Concrete Overlays in Motorway Maintenance (A Case Study). Proceedings of the 9th International Symposium on Concrete Roads, April 4–7, 2004, Istanbul, Turkey.
- Miller, J., and W. Bellinger. 2014. *Distress Identification Manual for the Long-Term Pavement Performance Program*. 4th Revised Edition. Federal Highway Administration, Washington, DC. <https://www.fhwa.dot.gov/publications/research/infrastructure/pavements/ltp/13092/13092.pdf>.
- Montanari, L., P. Suraneni, M. Moradillo, C. Wilson, A. Amirkhanian, M. Chang, C. Villani, S. Reese, and W. J. Weiss. 2021. *Examining Cost Saving Measures in Material Selection for Continuously Reinforced Concrete Pavement (CRCP): Volume 4*. ICT-21-014. Illinois Center for Transportation, Urbana, IL. <https://apps.ict.illinois.edu/projects/getfile.asp?id=9654>.
- OMB. 2020. *Guidelines and Discount Rates for Benefit-Cost Analysis of Federal Programs*. OMB Circular No. A-94. Office of Management and Budget, Washington, DC. <https://obamawhitehouse.archives.gov/sites/default/files/omb/assets/a94/a094.pdf>.
- PCA. 1976. *Continuously Reinforced Concrete Overlays: 1975 Condition Survey*. SR180.01P. Portland Cement Association, Skokie, IL.

- Pierce, L. Forthcoming. *NCHRP Project 1-61: Evaluation of Bonded Concrete Overlays on Asphalt Pavements*. National Cooperative Highway Research Program, Washington, DC. <https://apps.trb.org/cmsfeed/TRBNetProjectDisplay.asp?ProjectID=4351>.
- Renner, K. H. 1977. Design Criteria for Continuously Reinforced Concrete Overlay Based on Performance. First International Conference on Concrete Pavements, February 15-17, 1977, West Lafayette, IN.
- Rens, L. 2005. Continuously reinforced concrete: State of the art in Belgium. Austrian Conference on Concrete Roads, April 26, 2005, Vienna, Austria. pp. 32–35. <https://literatur.zement.at/themen/48-infrastruktur-strassenbau/5333-continuously-reinforced-concrete-state-of-the-art-in-belgium>.
- Roesler, J., A. Bordelon, A. Brand, and A. Amirhanian. 2019. *Fiber-Reinforced Concrete for Pavement Overlays: Technical Overview*. National Concrete Pavement Technology Center, Ames, IA. https://intrans.iastate.edu/app/uploads/2019/04/FRC_overlays_tech_ovw_w_cvr.pdf.
- Roesler, J., H. Chavan, D. King, and A. Brand. 2016. Concrete Slab Analyses with Field-Assigned Nonuniform Support Conditions. *International Journal of Pavement Engineering*, Vol. 17, No. 7, pp. 578–589.
- Roesler, J., J. T. Harvey, J. Farver, and F. Long. 2000. *Investigation of Design and Construction Issues for Long-Life Concrete Pavement Strategies*. FHWA/CA/OR-2000/04. California Department of Transportation, Sacramento, CA.
- Roesler, J., and J. Hiller. 2013. *Continuously Reinforced Concrete Pavement: Design Using the AASHTOWare Pavement ME Design Procedure*. Federal Highway Administration, Washington, DC. <https://www.fhwa.dot.gov/pavement/concrete/pubs/hif13025.pdf>.
- Roesler, J., J. Hiller, and A. Brand. 2016. *Continuously Reinforced Concrete Pavement Manual*. Federal Highway Administration, Washington, DC. <https://www.fhwa.dot.gov/pavement/concrete/pubs/hif16026.pdf>.
- Ryu, S., M. Park, J. Nam, Z. An, J. Bae, Y. Cho, and S. Lee. 2009. Initial Behavior of Thin-Bonded Continuously Reinforced Concrete Overlay (CRCO) on Aged Jointed Concrete Pavement. *New Technologies in Construction and Rehabilitation of Portland Cement Concrete Pavement and Bridge Deck Pavement*. American Society of Civil Engineers, Reston, VA. pp. 101–106.
- Ryu, S. W., H. Won, S. Choi, and M. Won. 2013. Continuously reinforced bonded concrete overlay of distressed jointed plain concrete pavements. *Construction and Building Materials*, Vol. 40, pp. 1110–1117.
- Smith, K. D., H. T. Yu, and D. G. Peshkin. 2002. *Portland Cement Concrete Overlays: State of the Technology Synthesis*. FHWA-IF-02-045. Federal Highway Administration, Washington, DC. <https://rosap.nrl.bts.gov/view/dot/49997>.
- Smith, K., D. Harrington, L. Pierce, P. Ram, and K. Smith. 2014. *Concrete Pavement Preservation Guide*. 2nd Edition. National Concrete Pavement Technology Center, Ames, IA. https://intrans.iastate.edu/app/uploads/2018/08/preservation_guide_2nd_ed_508_final.pdf.
- Snyder, M. B. 2011. *Guide to Dowel Load Transfer Systems for Jointed Concrete Roadway Pavements*. National Concrete Consortium, Institute for Transportation, Ames, IA. <https://intrans.iastate.edu/app/uploads/2018/08/Dowel-load-guide.pdf>.
- Snyder, M. B. 2019. *Stringless Paving*. FHWA-HIF-18-011. Federal Highway Administration, Washington, DC. <https://www.fhwa.dot.gov/pavement/pubs/hif18011.pdf>.
- Solanki, A. I., D. W. Fowler, and B. F. McCullough. 1987. *A Study of the Effect of Construction Variables on the Bond Behavior of CRCP Overlays*. FHWA/TX-88+457-4. Texas Department of Transportation, Austin, TX.
- Sriraman, S., and D. G. Zollinger. 1999. *Performance of CRC Pavements: Volume IV; Resurfacings for CRC Pavements*. FHWA-RD-98-100. Federal Highway Administration, Washington, DC. <https://www.fhwa.dot.gov/publications/research/infrastructure/pavements/pccp/98100/98100.pdf>.
- Strauss, P. J., B. D. Perrie, and D. Rossmann. 2005. Performance of a Thin CRCP Inlay Designed for a Five-Year Life: A Case Study. 8th International Conference on Concrete Pavements, August 14–18, 2005, Colorado Springs, CO.
- Sun, R., H. Won, and M. Won. 2011. The Application and Early-Age Behaviors of Continuously Reinforced Bonded Concrete Overlay of Distressed Jointed Concrete Pavements. *Pavements and Materials: Recent Advances in Design, Testing and Construction*. American Society of Civil Engineers, Reston, VA. pp. 208–215.

- Tayabji, S. D., D. G. Zollinger, G. T. Korovesis, P. J. Stephanos, and J. S. Gagnon. 1998. *Performance of Continuously Reinforced Concrete Pavements: Volume I; Summary of Practice and Annotated Bibliography*. FHWA-RD-94-178. Federal Highway Administration, Washington, DC. <https://ntlrepositary.blob.core.windows.net/lib/21000/21500/21598/PB99128274.pdf>.
- Tayabji, S., A. Gisi, J. Blomberg, and D. DeGraaf. 2009. New Applications for Thin Concrete Overlays: Three Case Studies. *Proceedings: National Conference on Preservation, Repair, and Rehabilitation of Concrete Pavements; St. Louis, Missouri, April 22–24, 2009*. Concrete Pavement Technology Program, Federal Highway Administration, Washington DC. <https://rosap.ntl.bts.gov/view/dot/25961>.
- Taylor, P. 2013. *Curing Concrete*. 1st Edition. CRC Press, Boca Raton, FL. <https://www.routledge.com/Curing-Concrete/Taylor/p/book/9780367865566>.
- Taylor, P., T. Van Dam, L. Sutter, and G. Fick. 2019. *Integrated Materials and Construction Practices for Concrete Pavements: A State-of-the-Practice Manual*. 2nd Edition. National Concrete Pavement Technology Center, Ames, IA. https://intrans.iastate.edu/app/uploads/2019/05/IMCP_manual.pdf.
- Tenison, J. H., and D. I. Hanson. 2009. *NCHRP Synthesis 388: Pre-overlay Treatment of Existing Pavements*. National Cooperative Highway Research Program, Washington, DC. <http://www.trb.org/Publications/Blurbs/160762.aspx>.
- Torres, H.N., J. Roesler, R. O. Rasmussen, and D. Harrington. 2012. *Guide to the Design of Concrete Overlays Using Existing Methodologies*. National Concrete Pavement Technology Center, Ames, IA. https://intrans.iastate.edu/app/uploads/2018/08/Overlays_Design_Guide_508.pdf.
- The Transtec Group. 2021. HIPERPAV. The Transtec Group, Austin, TX. <https://www.thetranstecgroup.com/hiperpav/>.
- Tyner, H. L., W. Gulden, and D. Brown. 1981. Resurfacing of Plain Jointed-Concrete Pavement. *Transportation Research Record: Journal of the Transportation Research Board*, Vol. 814, pp. 41–45.
- Van Dam, T. J., J. T. Harvey, S. T. Muench, K. D. Smith, M. B. Snyder, I. L. Al-Qadi, H. Ozer, J. Meijer, P. V. Ram, J. R. Roesler, and A. Kendall. 2015. *Towards Sustainable Pavement Systems: A Reference Document*. FHWA-HIF-15-002. Federal Highway Administration, Washington, DC. <https://rosap.ntl.bts.gov/view/dot/38541>.
- Vandenbossche, J., and M. Barman. 2010. Bonded Whitetopping Overlay Design Considerations for Prevention of Reflection Cracking, Joint Sealing, and the Use of Dowel Bars. *Transportation Research Record: Journal of the Transportation Research Board*, Vol. 2155, pp. 3–11.
- Verhoeven, K. 1989. Thin Overlay of Steel Fiber Reinforced Concrete and Continuously Reinforced Concrete: State of the Art in Belgium. Fourth International Conference on Concrete Pavements, April 18–20, 1989, West Lafayette, IN. pp. 205–219.
- Voigt, G. F., and E. Ferreebee. 2016. *Dowel Basket Anchoring Methods: Best Practices for Jointed Concrete Pavements*. FHWA-HIF-16-021. Federal Highway Administration, Washington, DC. <https://www.fhwa.dot.gov/pavement/concrete/pubs/hif16021.pdf>.
- Weiss, W. J., J. Olek, N. M. Whiting, P. Panchmatia, C. Qiao, and P. Suraneni. 2018. *Synthesis: Accelerating Implementation of Research Findings to Reduce Potential Concrete Pavement Joint Deterioration*. FHWA/IN/JTRP-2018/24. Purdue University, West Lafayette, IN. <https://doi.org/10.5703/1288284316869>.
- Złotowska, M., R. Nagórski, P. Radziszewski, M. Sarnowski, and P. Tutka. 2019. Flexible pavement rehabilitation with continuously reinforced concrete slab with HFRP bars: mechanistic analysis. *MATEC Web of Conferences*, Vol. 262. https://www.matec-conferences.org/articles/mateconf/pdf/2019/11/mateconf_krynica2018_05019.pdf.
- Zollinger, D., M. Won, T. Ley, K. Riding, A. Wimsatt, W. Zhou, S. Ryu, and P. Choi. 2014. *Implementation of Curing, Texturing, Subbase, and Compaction Measurement Alternatives for Continuously Reinforced Concrete Pavement Implementation of Curing, Texturing, Subbase, and Compaction Measurement Alternatives for Continuously Reinforced Concrete*. FHWA/TX-13/5-6037-01-1. Texas A&M Transportation Institute, College Station, TX. <https://static.tti.tamu.edu/tti.tamu.edu/documents/5-6037-01-1.pdf>.

National Concrete Pavement
Technology Center

