

TYPE E

Two-piece fixed casting

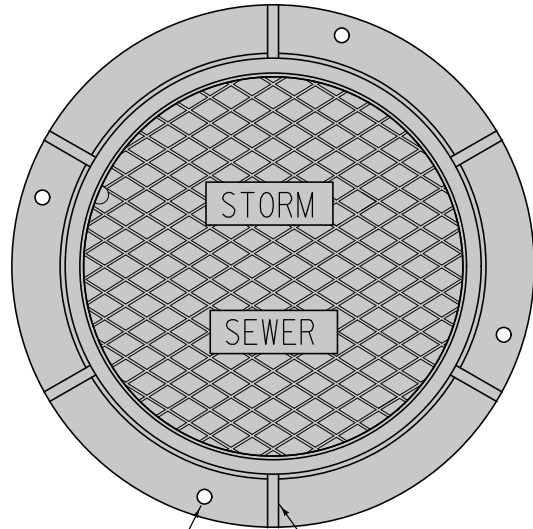

Anchor Bolt Hole ① Flange (typ.)

PLAN

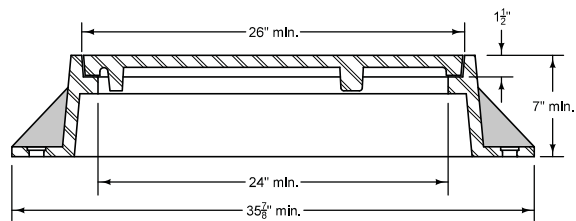

TYPICAL SECTION

TYPE F

Three-piece floating casting

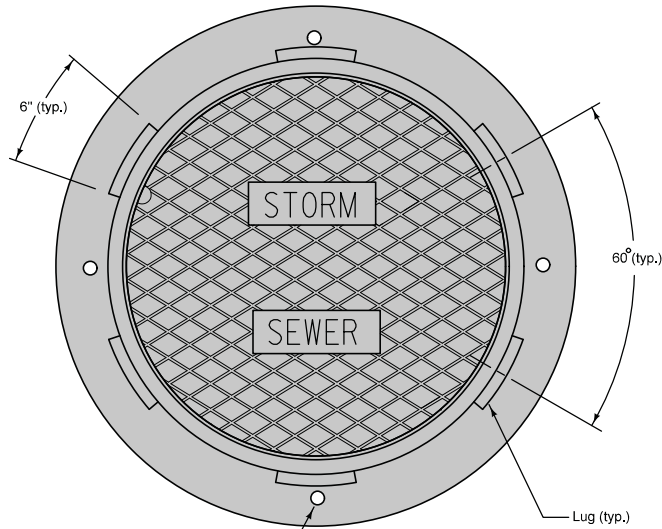

Anchor Bolt Hole ① Lug (typ.)

PLAN

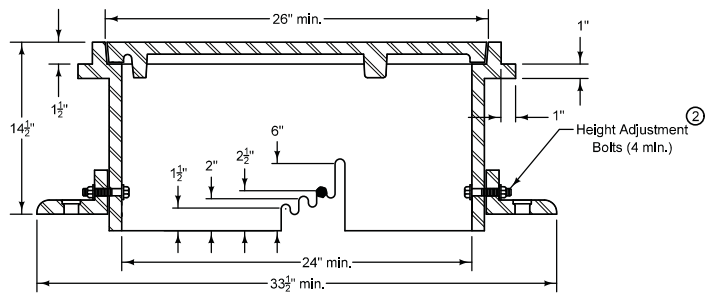

TYPICAL SECTION

Frame Notes:
Size and spacing of lugs and flanges may vary.

Cover Notes:
Roughness pattern and text styles may vary.
Minimum one concealed pickhole.

- ① When the contract documents require the frame to be attached to the structure, drill four $\frac{7}{8}$ " diameter holes or slots, equally spaced around frame.
- ② Set casting at proper grade using one of the adjustment slots. Remove bolts upon completion of paving.

FIGURE 6010.602 SHEET 1 OF 2

		REVISION
		3 04-21-15
FIGURE 6010.602	STANDARD ROAD PLAN	SW-602
		SHEET 1 of 2
REVISIONS: Revised three-piece casting configuration. Modified circle note 2.		
SUDAS DIRECTOR		DESIGN METHODS ENGINEER
CASTINGS FOR STORM SEWER MANHOLES		

TYPE G
Two-piece fixed casting

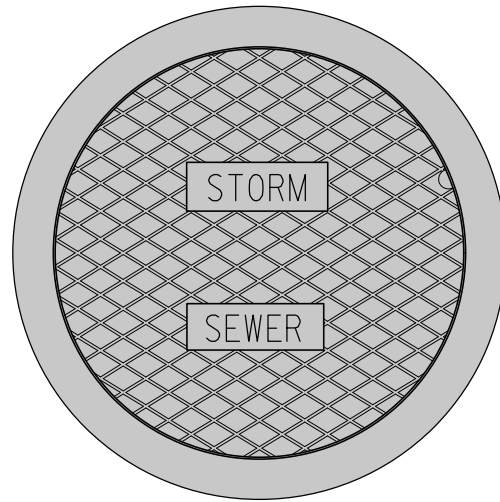

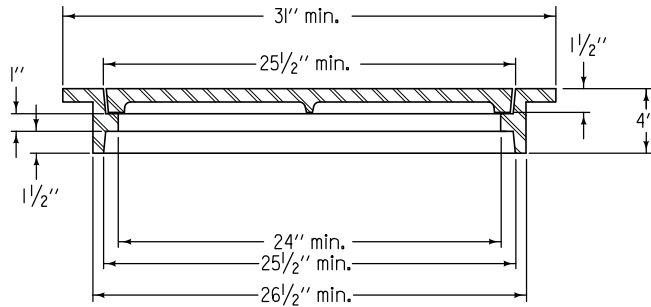

PLAN



TYPICAL SECTION

FIGURE 6010.602 SHEET 2 OF 2

 SUDAS	 IOWADOT	REVISION
		3 04-21-15
FIGURE 6010.602	STANDARD ROAD PLAN	SW-602
		SHEET 2 of 2
<small>REVISIONS: Revised three-piece casting configuration. Modified circle note 2.</small>		
<i>Paul D. Wigand</i> <small>SUDAS DIRECTOR</small>		<i>Brian Smith</i> <small>DESIGN METHODS ENGINEER</small>
CASTINGS FOR STORM SEWER MANHOLES		