

POST INSTALLATION

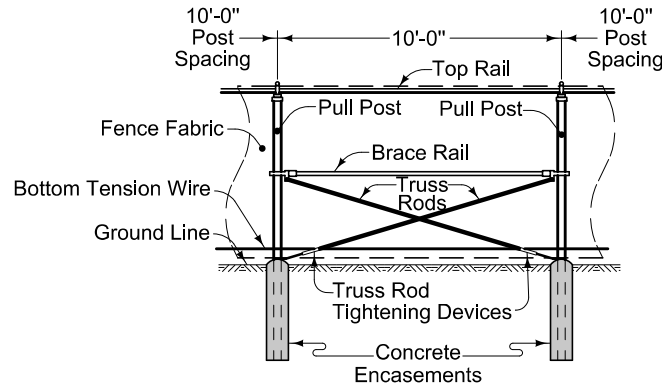

PULL POST INSTALLATION

Place fence fabric on roadway side of post. For certain curves, stream crossings, or other locations, the Contractor has the option to place fabric on the side of the post away from the roadway.

- ① Fabric width as specified in the contract documents.
- ② For fence heights greater than 8 feet, the depth of the fence post footing is 3 feet plus 3 inches for each 1 foot in height over 8 feet.
- ③ Install the fence on the roadway side of the right-of-way when specified in the contract documents.

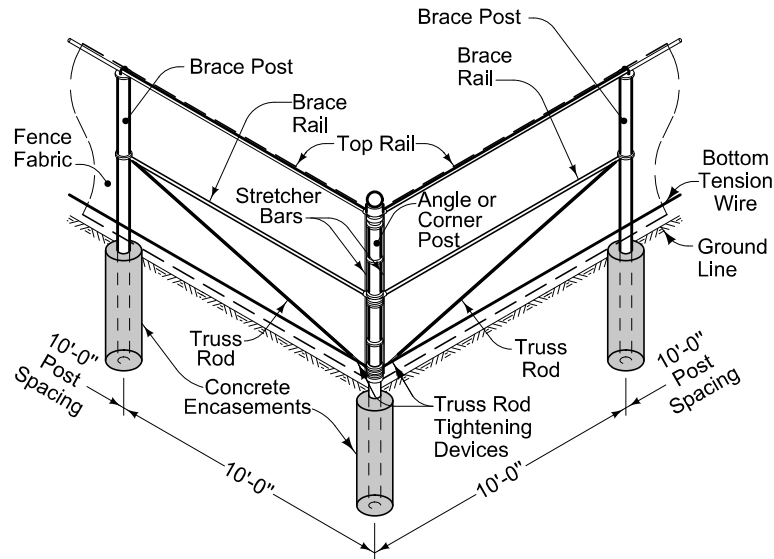

ANGLE OR CORNER POST INSTALLATION

FENCE POST FOOTING DEPTH AND DIAMETER

USE IN FENCE	FENCE HEIGHT					
	4'-0" and less		Over 4'-0" to 8'-0"		Over 8'-0"	
	X	Y	X	Y	X	Y
Line and Brace Posts	0'-8"	3'-0"	0'-10"	3'-0"	1'-0"	②
Terminal Post*	0'-10"	3'-0"	1'-0"	3'-0"	1'-4"	②

*Includes corner, angle, end, and pull posts.

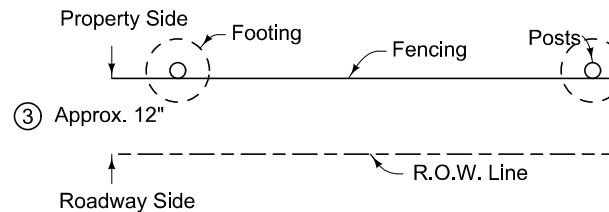

PLAN OF FENCE

	REVISION
	New 10-18-11
SUDAS	9060.101
SHEET 1 of 2	
SUDAS Standard Specifications	
CHAIN LINK FENCE	

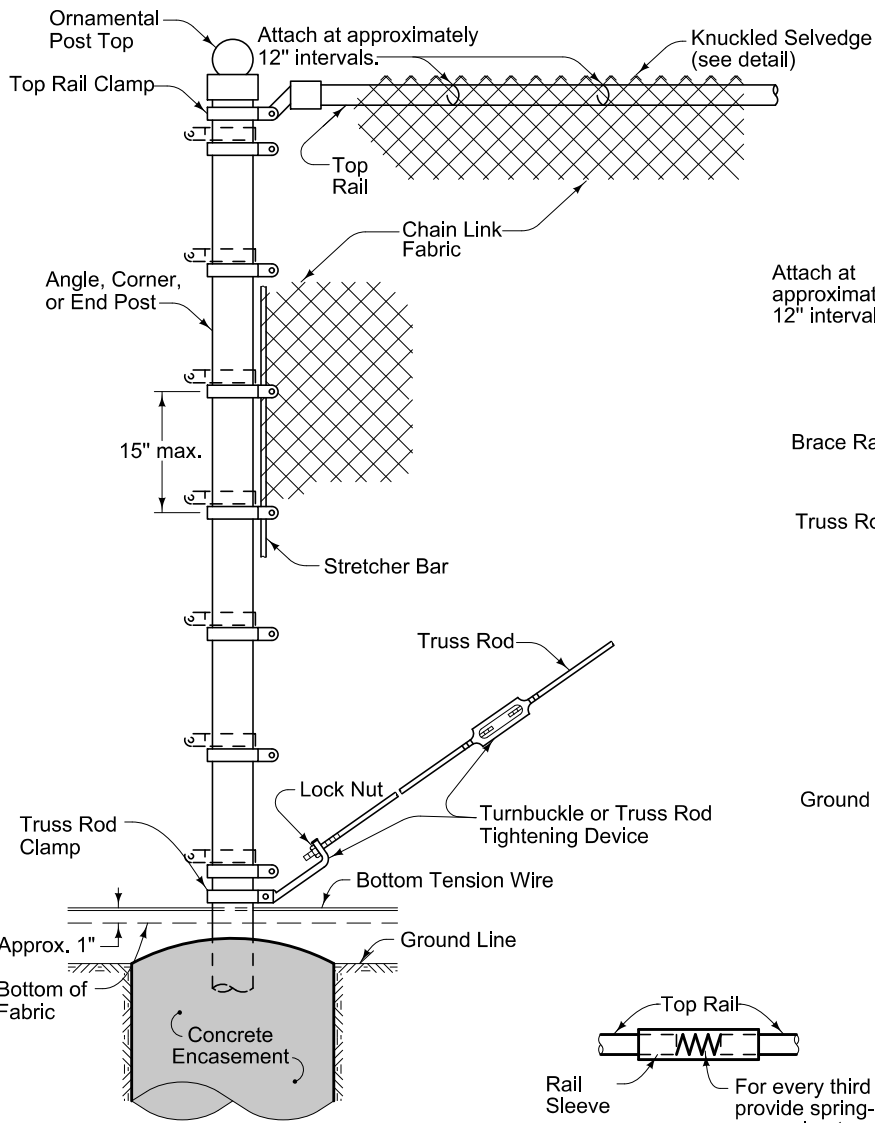

ANGLE, CORNER, OR END POST ASSEMBLY

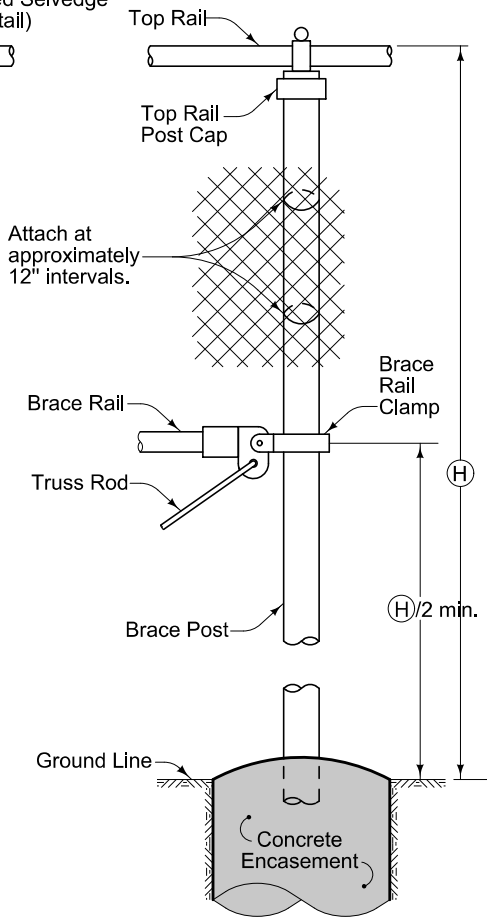

BRACE POST ASSEMBLY

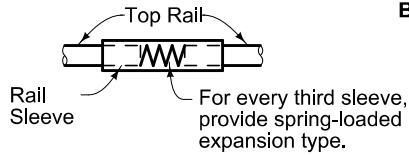

RAIL SLEEVE

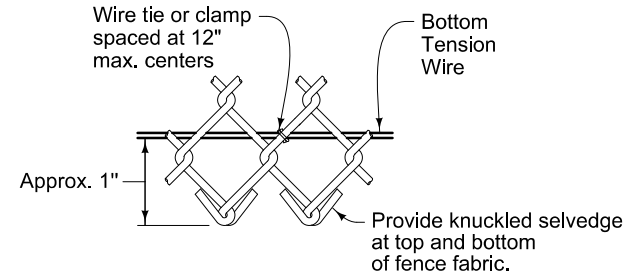

BOTTOM TENSION WIRE AND KNUCKLED SELVEDGE

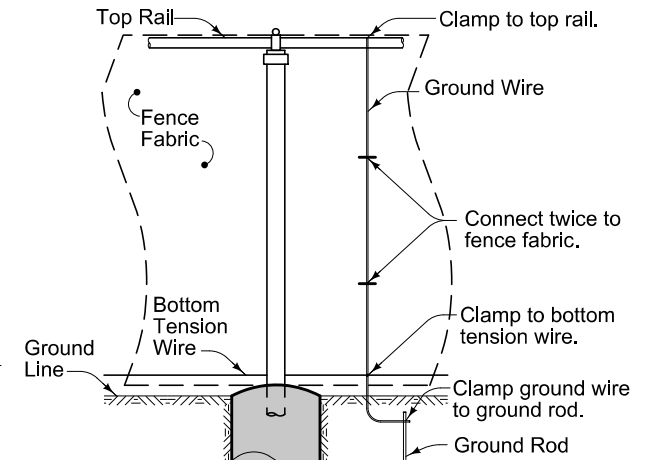

GROUND ROD INSTALLATION

FIGURE 9060.101 SHEET 2 OF 2

	REVISION New 10-18-11
	9060.101
	SHEET 2 of 2
SUDAS Standard Specifications	
CHAIN LINK FENCE	