



Table of Contents

Chapter 7 - Erosion and Sediment Control

7A General Information

7A-1-----General Information

- A. Purpose..... 1
- B. Background..... 1
- C. Definitions..... 2

7B Regulatory Requirements

7B-1-----Regulatory Requirements

- A. National Pollutant Discharge Elimination System (NPDES)..... 1
- B. NPDES Construction Site Permitting..... 2
- C. Stormwater Pollution Prevention Plans (SWPPP)..... 4
- D. Who is Responsible..... 9
- E. Transfer of Ownership and Responsibilities 10

7C The Erosion and Sedimentation Process

7C-1-----The Erosion and Sedimentation Process

- A. The Erosion Process..... 1
- B. Factors Affecting Erosion..... 3
- C. Sediment Transportation..... 4

7D Design Criteria

7D-1-----Design Criteria

- A. Introduction..... 1
- B. Erosion Control..... 2
- C. Calculating Soil Loss..... 3
- D. Sediment Removal..... 3

7E Design Information for Erosion and Sediment Control Measures

7E-1-----Design Information for Erosion and Sediment Control Measures

- A. General..... 1
- B. Flow Control..... 1
- C. Erosion Control..... 1
- D. Sediment Control..... 1
- E. Runoff Reduction..... 1
- F. Flow Diversion..... 1
- G. Selecting Control Measures..... 2

7E Design Information for Erosion and Sediment Control Measures (Continued)

7E-2-----	Compost Blanket	
A.	Description/Uses.....	2
B.	Design Considerations.....	2
C.	Application.....	2
D.	Maintenance.....	3
E.	Time of Year.....	3
F.	Regional Location.....	3
7E-3-----	Filter Berms	
A.	Description/Uses.....	2
B.	Design Considerations.....	2
C.	Application.....	2
D.	Maintenance.....	3
7E-4-----	Filter Socks	
A.	Description/Uses.....	2
B.	Design Considerations.....	2
C.	Application.....	4
D.	Maintenance.....	4
7E-5-----	Temporary Rolled Erosion Control Products (RECP)	
A.	Description/Uses.....	2
B.	Design Considerations.....	2
C.	Application.....	5
D.	Maintenance.....	5
E.	Time of Year.....	5
F.	Design Example.....	5
7E-6-----	Wattles	
A.	Description/Uses.....	2
B.	Design Considerations.....	2
C.	Application.....	3
D.	Maintenance.....	3
7E-7-----	Check Dams	
A.	Description/Uses.....	2
B.	Design Considerations.....	2
C.	Application.....	4
D.	Maintenance.....	4
E.	Time of Year.....	5
F.	Regional Location.....	5
7E-8-----	Temporary Earth Diversion Structures	
A.	Description/Uses.....	2
B.	Design Considerations.....	2
C.	Application.....	3
D.	Maintenance.....	3
E.	Time of Year.....	3
F.	Regional Location.....	3

7E Design Information for Erosion and Sediment Control Measures (Continued)

7E-9-----	Level Spreaders	
A.	Description/Uses.....	2
B.	Design Considerations.....	2
C.	Application.....	2
D.	Maintenance.....	2
E.	Time of Year.....	3
F.	Regional Location.....	3
7E-10-----	Rip Rap	
A.	Description/Uses.....	2
B.	Design Considerations.....	2
C.	Application.....	4
D.	Maintenance.....	4
7E-11-----	Temporary Pipe Slope Drains	
A.	Description/Uses.....	2
B.	Design Considerations.....	2
C.	Application.....	4
D.	Maintenance.....	4
E.	Design Example.....	4
7E-12-----	Sediment Basin	
A.	Description/Uses.....	2
B.	Design Considerations.....	2
C.	Application.....	17
D.	Maintenance.....	17
E.	Design Example.....	17
7E-13-----	Sediment Traps	
A.	Description/Uses.....	2
B.	Design Considerations.....	2
C.	Application.....	3
D.	Maintenance.....	3
7E-14-----	Silt Fences	
A.	Description/Uses.....	2
B.	Design Considerations.....	2
C.	Application.....	3
D.	Maintenance.....	4
E.	Time of Year.....	4
7E-15-----	Stabilized Construction Entrance	
A.	Description/Uses.....	2
B.	Design Considerations.....	2
C.	Application.....	3
D.	Maintenance.....	3

7E Design Information for Erosion and Sediment Control Measures (Continued)

7E-16-----Dust Control	
A. Description/Uses.....	2
B. Design Considerations.....	2
C. Application.....	3
D. Maintenance.....	3
7E-17-----Erosion Control Mulching	
A. Description/Uses.....	2
B. Design Considerations.....	2
C. Application.....	3
D. Maintenance.....	4
E. Time of Year.....	4
7E-18-----Turf Reinforcement Mats (TRM)	
A. Description/Uses.....	2
B. Design Considerations.....	2
C. Application.....	3
D. Maintenance.....	4
E. Design Example.....	4
7E-19-----Surface Roughening	
A. Description/Uses.....	2
B. Design Considerations.....	2
C. Application.....	3
D. Maintenance.....	3
7E-20-----Inlet Protection	
A. Description/Uses.....	2
B. Design Considerations.....	2
C. Application.....	3
D. Maintenance.....	3
7E-21-----Flow Transition Mats	
A. Description/Uses.....	2
B. Design Considerations.....	2
C. Application.....	3
D. Maintenance.....	3
7E-22-----Temporary Erosion Control Seeding	
A. Description/Uses.....	2
B. Design Considerations.....	2
C. Application.....	3
D. Maintenance.....	4
E. Time of Year.....	4

7E Design Information for Erosion and Sediment Control Measures (Continued)

7E-23-----	Grass Channel	
A.	Description/Uses.....	2
B.	Design Considerations.....	2
C.	Application.....	7
D.	Maintenance.....	7
E.	Time of Year.....	7
F.	Design Example.....	7
7E-24-----	Permanent Seeding	
A.	Description/Uses.....	2
B.	Design Considerations.....	2
C.	Application.....	4
D.	Maintenance.....	4
E.	Time of Year.....	4
7E-25-----	Sodding	
A.	Description/Uses.....	2
B.	Design Considerations.....	2
C.	Application.....	4
D.	Maintenance.....	4
E.	Time of Year.....	4
7E-26-----	Vegetative Filter Strip	
A.	Description/Uses.....	2
B.	Design Considerations.....	2
C.	Application.....	2
D.	Maintenance.....	3
7E-27-----	Rock Chutes and Flumes	
A.	Description/Uses.....	2
B.	Design Considerations.....	2
C.	Application.....	2
D.	Maintenance.....	2
7E-28-----	Flocculents	
A.	Description/Uses.....	2
B.	Design Considerations.....	2
C.	Application.....	2
D.	Maintenance.....	3
E.	Time of Year.....	3
7E-29-----	Flotation Silt Curtain	
A.	Description/Uses.....	2
B.	Design Considerations.....	2
C.	Application.....	3
D.	Maintenance.....	3
E.	Time of Year.....	3

7F Appendix

7F-1-----Appendix

7G References

7G-1-----References

General Information

A. Purpose

In an effort to protect the nation's waters from pollution, the Environmental Protection Agency (EPA) has developed a system of regulations, under the Clean Water Act, entitled the National Pollutant Discharge Elimination System (NPDES). These regulations require the owner of a site to obtain a permit prior to construction, and ensure that proper steps are taken during construction to help prevent erosion and prevent sediment from leaving construction sites.

The purpose of this chapter is to explain the erosion and sedimentation process, and describe methods that may be used to protect natural resources by reducing both. In addition, the steps required to comply with the EPA's NPDES regulatory requirements will be explained. The regulatory information in this section is included as a convenience to the designer. The actual regulations of the Iowa Department of Natural Resources (DNR) govern if there are any discrepancies.

B. Background

Approximately 40% of the nation's waterways have been identified as impaired, meaning that they do not meet the water quality standards for their intended use. In Iowa, the most common reason for a waterway to be designated as impaired is due to high levels of suspended sediment. One of the main sources of suspended sediment found in waterways is construction site stormwater runoff.

Sediment in runoff from construction sites is a direct result of the erosion created when the site is stripped of its stabilizing vegetation. According to the U.S. Environmental Protection Agency (EPA), sediment rates in stormwater runoff from construction sites are typically 10 to 20 times greater than for agricultural lands. In urban areas, stormwater runoff is quickly intercepted by the storm sewer and does not have a chance to travel over vegetated areas where suspended sediment can be removed. The sediment in this runoff eventually reaches streams, ponds, lakes, and rivers. High levels of suspended sediment can quickly form large silt deposits, filling in these waterways.

Silt deposits can cause damage to public and private property. Silt deposits often flow onto adjacent property, causing damage; flow onto public streets, creating mud and dust; and clog storm sewers and ditches. The financial impact caused by this sediment is substantial. Waterways must be dredged to remove the deposits, streets swept, ditches and storm sewers cleaned, and property damaged by sediment must be repaired or replaced. While the financial impacts are significant, the loss of natural resources is just as important.

High levels of sediment in storm runoff can impact an ecosystem. Sediment is often contaminated with other pollutants such as phosphorous, nitrates, pesticides, and heavy metals. In high enough concentrations, these pollutants become poisonous. In addition, the suspended sediment filters out sunlight, killing off aquatic vegetation. Many species of animals depend on this vegetation for habitat and nourishment. If enough vegetation is destroyed, the levels of dissolved oxygen in the water can drop to levels where aquatic wildlife cannot survive. Waterfowl and other animals, dependent on the fish and vegetation for sustenance, may die or leave the area.

C. Definitions

Aggregate: Crushed rock or gravel screened to different sizes for various uses in construction projects.

Annual Plant: A plant that completes its life cycle and dies in one year or less.

Apron: A floor or lining to protect a surface from erosion. Normally at the inlet or outlet of a storm conduit.

Berm: A raised area that breaks the continuity of a slope.

Best Management Practices: Schedules of activities, prohibitions of practices, maintenance procedures, and other management practices to prevent or reduce the pollution of waters of the United States. BMPs also include treatment requirements, operating procedures, and practices to control plant site runoff, spillage or leaks, sludge or waste disposal, or drainage from raw material storage.

Channel: A stream that conveys continuous or intermittent water; a ditch or channel excavated for the flow of water.

Channel Stabilization: Erosion prevention and stabilization of velocity distribution in a channel using jetties, drops, revetments, vegetation, and other measures.

Clay (Soils): (1) A mineral soil separate consisting of particles less than 6.6×10^{-6} feet (0.002 mm) in equivalent diameter. (2) A soil textural class. (3) A fine-grained soil that has a high plasticity index in relation to the liquid limits.

Clean Water Act (CWA): The Federal Water Pollution Control Act.

Clod: A compact, coherent mass of soil 2 inches or larger, produced artificially, usually by digging, etc., especially when these operations are performed on soils that are either too wet or too dry for normal soil movement.

Code of Federal Regulations (CFR): A codification of the final rules published daily in the Federal Register. Title 40 of the CFR contains the environmental regulations.

Compaction: The process by which the soil grains are rearranged to decrease void space and bring the grains into closer contact with one another and thereby increase the weight of solid material per cubic foot.

Construction Site: A site or common plan of development or sale on which construction activity, including clearing, grading, and excavating, results in soil disturbance. A construction site is considered one site if all areas of the site are contiguous with one another and one entity owns all areas of the site.

Contour: An imaginary line on the surface of the ground connecting points of the same elevation.

Cover: (1) Vegetation or other material providing protection. (2) Ground and soils: any vegetation producing a protective mat on or just above the soil surface. (3) Stream: generally trees, large shrubs, grasses, and forbs that shade and otherwise protect the stream from erosion, temperature elevation, or sloughing of banks. (4) Vegetation: all plants of all sizes and species found on an area, regardless of whether they have forage or other value. (5) Artificial: any material (natural or synthetic) that is spread or rolled out over the ground to protect the surface from erosion.

Detention Basin (Pond): A structure barrier built to divert part or all of the runoff water from a land area and to release the water under a controlled condition.

Drainage: The removal of excess surface water or groundwater from a land area.

Erosion: (1) The wearing away of the land surface by running water, wind, ice, or other geological agents, including such processes as gravitational creep. (2) Detachment and movement of soil or rock fragments by water, wind, ice, or gravity.

Filter Strip: Strip of vegetation above ponds, diversion structures, or other elements to retard flow of runoff water and thereby reduce sediment flow.

Final Stabilization: Period when all soil-disturbing activities at the site have been completed and a uniform perennial vegetative cover with a density of 70%, sufficient to preclude erosion, for the entire disturbed area of the permitted project has been established, or equivalent stabilization measures have been employed, or which has been returned to agricultural production.

Gabion: A rectangular or cylindrical wire mesh cage filled with rock and used as a protecting apron, revetment, retaining wall, etc., against erosion.

General Permit: An NPDES permit issued under 40 CFR 122.28 that authorizes a category of discharges under the CWA within a geographical area. A general permit is not specifically tailored for an individual discharger.

Grade: (1) The slope of a road, channel, or natural ground, or any surface prepared for the support of construction such as paving. (2) To finish the surface of a roadbed, top of embankment, or bottom of excavation.

Grass: A member of the botanical family Gramineae characterized by blade-like leaves arranged on the culm or stem in two ranks.

Grassed Channel (Waterway): A natural or constructed waterway, usually broad and shallow, covered with erosion-resistant grasses, used to conduct surface water from land.

Ground Cover: Grasses or other plants grown to keep soil from being blown or washed away.

Gully: A channel or miniature valley cut by concentrated runoff, through which water commonly flows only during and immediately after heavy rains, or during the melting of snow. The gullies may be branching or linear, rather long, narrow, and of uniform width. The difference between a gully and rill is the depth. A gully is sufficiently deep that it would not be obliterated by tillage operations. A rill of lesser depth can be smoothed by regular tillage equipment.

Infeasible: Not technologically possible or not economically practicable and achievable in light of best industry practices.

Infiltration: The gradual downward flow of water from the surface through soil to ground water and water table reservoirs.

Large Construction Activity: As defined in 40 CFR 122.26(b)(14)(x), a large construction activity includes clearing, grading, and excavating, resulting in a land disturbance that will disturb five acres or more of land, or will disturb fewer than five acres of total land area, but is part of a larger common plan of development or sale that will ultimately disturb five acres or more. Large construction activity does not include routine maintenance that is performed to maintain the original line and grade, hydraulic capacity, or original purpose of the site.

Legume: A member of the Leguminosae family, one of the most important and widely distributed plant families. Leaves are alternate, have stipples, and are usually compound. Most legumes are nitrogen-fixing plants.

Loess: Soil material transported and deposited by wind and consisting predominantly of silt-sized particles.

Mulch: A natural or artificial layer of plant residue, or other materials such as straw, leaves, bark, sand, or gravel on the soil surface, to protect the soil and plant roots from the effects of raindrops, soil crusting, freezing, evaporation, etc.

Municipal Separate Storm Sewer System (MS4): A conveyance or system of conveyances (including roads with drainage systems, municipal streets, catch basins, curbs, gutters, ditches, man-made channels, or storm drains) meeting the following criteria:

- a. Owned and operated by a state, city, town, borough, county, parish, district, association, or other public body (created by or pursuant to state law) having jurisdiction over disposal of sewage, industrial wastes, stormwater, or other wastes, including special districts under state law such as a sewer district, flood control district or drainage district, or similar entity, or an Indian tribe or an authorized Indian tribal organization, or a designated and approved management agency under section 208 of the Clean Water Act (CWA) that discharges to waters of the United States.
- b. Designed or used for collecting or conveying stormwater
- c. Which is not a combined sewer
- d. Which is not part of a publicly owned treatment works (POTW)

National Pollutant Discharge Elimination System (NPDES): National program under Section 402 of the Clean Water Act for regulation of discharges of pollutants from point sources to waters of the United States. Discharges are illegal unless authorized by an NPDES permit.

Nurse Crop: Seeding of a short-life crop with a permanent species to aid in erosion control until the permanent species are established.

Organic Matter: Decomposition products of plant and animal materials, such as litter, leaves, and manure.

Perennial Plant: A plant that normally lives three years or longer.

Permeability, Soil: The quality of a soil horizon that enables water or air to move through it. The permeability of a soil may be limited by the presence of one nearly impermeable horizon even though the others are permeable.

Permitting Authority: The United States EPA, a Regional Administrator of the EPA, or an authorized representative. Under the Clean Water Act, most states are authorized to implement the NPDES permit program.

pH: A measure of hydrogen ion concentration. Values range from 0 to 14; a pH of 7.0 is neutral. All pH values below 7.0 are acidic, and all above 7.0 are alkaline.

Planting Season: The period of the year when planting or transplanting is considered advisable from the standpoint of successful establishment.

Point Source: Any discernible, confined, and discrete conveyance, including but not limited to, any pipe, ditch, channel, tunnel, conduit, well, discrete fissure, container, rolling stock concentrated animal feeding operation (CAFO), landfill leachate collection system, vessel, or other floating craft from which pollutants are or may be discharged. This term does not include return flows from irrigated agriculture or agricultural stormwater runoff.

Pollutant: Dredged spoil, solid waste, incinerator residue, filter backwash, sewage, garbage, sewage sludge, munitions, chemical wastes, biological materials, radioactive materials (except those regulated under the Atomic Energy Act of 1954, as amended (42 U.S.C. 2011 et seq.)), heat, wrecked or discarded equipment, rock, sand, cellar dirt, and industrial, municipal, and agricultural waste discharged into water.

Qualified Personnel: Those individuals capable enough and knowledgeable enough to perform the required functions adequately well to ensure compliance with the relevant permit conditions and requirements of the Iowa Administrative Code.

Receiving Water: The "Water of the United States" as defined in 40 CFR 122.2 into which the regulated stormwater discharges.

Revetment: Facing of rip rap, or other material, either permanent or temporary, placed along the edge of a stream to stabilize the bank and protect it from the erosive action of the stream.

Rip Rap: Broken rock, cobbles, or boulders placed as revetment on earth surfaces such as the face of a dam or the bank of a stream, for the protection against the action of water or waves.

Runoff: That portion of the precipitation on a drainage area that is discharged from the area. Includes surface runoff and groundwater runoff.

Section 401 Certification: A requirement of Section 401(a) of the Clean Water Act that all federally issued permits be certified by the state in which the discharge occurs. The state certifies that the proposed permit will comply with state water quality standards and other state requirements.

Sediment: Solid material, both mineral and organic, that is in suspension, is being transported, or has been moved from its site of origin by air, water, gravity, or ice.

Seed: The fertilized and ripened ovule of a seed plant that is capable, under suitable conditions, of independently developing into a plant similar to the one that produced it.

Seedbed: The soil prepared by natural or artificial means to promote the germination of seed and the growth of seedlings.

Small Construction Activity: Clearing, grading, and excavating resulting in a land disturbance that will disturb one acre or more and fewer than five acres of total land area, but is part of a larger common plan of development or sale that will ultimately disturb five or fewer acres. Small construction activity does not include routine maintenance that is performed to maintain the original line and grade, hydraulic capacity, or original purpose of the site.

Sod: A closely knit ground cover growth, primarily of grasses, held together by its roots.

Soil Amendment: Any material, such as compost, lime, gypsum, sawdust, or synthetic conditioner that is worked into the soil to make it more productive. This term is used most commonly for added materials other than fertilizer.

Soil Horizon: A layer of soil, approximately parallel to the soil surface, with distinct characteristics produced by soil-forming processes.

Soil Stabilization: The prevention of soil particles from being dislodged and moving, therefore preventing erosion from initiating or continuing.

Soil Structure: The combination or arrangement of primary soil particles into secondary particles or units. The secondary particles are characterized by size, shape, and degree of distinctness into classes, types, and grades.

Stormwater: Storm runoff, snow melt runoff, and surface runoff and drainage.

Stormwater Discharge Related Activities: Activities that cause, contribute to, or result in stormwater point source pollutant discharges, including excavation, site development, grading, and other surface disturbance activities; and measures to control stormwater, including the siting, construction, and operation of BMPs to control, reduce, or prevent stormwater pollution.

Stubble: The base portion of plants remaining after the top portion has been harvested.

Tacking: The process of binding mulch fibers together by adding a sprayed chemical compound.

Topsoil: The unconsolidated earthy material that exists in its natural state and is or can be made favorable to the growth of desirable vegetation. Usually the A-horizon of soils with developed profiles.

Uncontaminated Groundwater: Water that is potable for humans, meets the narrative water quality standards in subrule 567-61.3(2) of the Iowa Administrative Code, contains no more than half the listed concentration of any pollutants in subrule 567-61.3(3) of the IAC, has a pH of 6.5-9.0, and is located in soil or rock strata.

Vegetation: Plants in general or all plant life in the area.

Water(s) of the State: Any stream, lake, pond, marsh, watercourse, waterway, well, spring, reservoir, aquifer, irrigation system, drainage system, and any other body or accumulation of water, surface or underground, natural or artificial, public or private, which are contained within, flow through, or border upon the State of Iowa or any portion thereof.

Waters of the United States: All waters that are currently used, were used in the past, or may be susceptible to use in interstate or foreign commerce, including all waters subject to the ebb and flow of the tide. Waters of the United States include all interstate waters and intrastate lakes, rivers, streams (including intermittent streams), mudflats, sand flats, wetlands, sloughs, prairie potholes, wet meadows, playa lakes, or natural ponds.

Weed: An undesired uncultivated plant.

Wetlands: Areas that are inundated or saturated by surface or groundwater at a frequency and duration sufficient to support, and that under normal circumstances do support, a prevalence of vegetation typically adapted for life in saturated soil conditions. Wetlands generally include swamps, marshes, bogs, and similar areas.

Regulatory Requirements

A. National Pollutant Discharge Elimination System (NPDES)

The Clean Water Act established a set of requirements called the National Pollutant Discharge Elimination System (NPDES). The NPDES regulates stormwater discharges associated with industrial activities, municipal storm sewer systems, and construction sites. The purpose of these regulations is to reduce pollution of the nation's waterways. At the present time there are no specific loss monitoring requirements. Uses of Best Management Practices (BMP) identified in an approved Stormwater Pollution Prevention Plan (SWPPP) have been identified as the means and methods to meet the NPDES requirements. On-going discussions indicate that in the future where NPDES authorities determine that construction discharges have the reasonable potential to cause or contribute to a water quality standard excursion, numeric effluent limitations may be imposed. In the future, specific emphasis will be placed on containing soil erosion and minimizing soil compaction.

The intent of this section is to describe the regulations and permitting requirements of the NPDES as they relate to construction sites. Refer to Chapter 2 - Stormwater for additional information.

Federal Construction and Development Effluent Guidelines for all sites and activities required to be authorized under NPDES permits shall comply with the following federal effluent guidelines as applicable to each site and activity. These requirements will be implemented by the Iowa Department of Natural Resources in conjunction with the General Permit No. 2 requirements.

1. **Erosion and Sediment Controls:** Design, install, and maintain effective erosion controls and sediment controls to minimize the discharge of pollutants. At a minimum such controls must be designed, installed, and maintained to:
 - a. Control stormwater volume and velocity to minimize soil erosion in order to minimize pollutant discharges.
 - b. Control stormwater discharges including both peak flow rates and total stormwater volume, to minimize channel and streambank erosion and scour in the immediate vicinity of discharge points.
 - c. Minimize the amount of soil exposed during construction activity.
 - d. Minimize the disturbance of steep slopes.
 - e. Minimize sediment discharges from the site. The design, installation, and maintenance of erosion and sediment controls must address factors such as the amount, frequency, intensity, and duration of precipitation, the nature of the resulting stormwater runoff and soil characteristics including the range of soil particle sizes expected to be present on the site.
 - f. Provide and maintain natural buffers around waters of the United States, direct stormwater to vegetated areas, and maximize stormwater infiltration to reduce pollutant discharges, unless infeasible.

2. **Soil Compaction and Topsoil Preservation:** Implement practices to minimize soil compaction and preserve topsoil according to Part IV D of the General Permit No. 2.

3. **Soil Stabilization:** Stabilization of disturbed areas must, at a minimum, be initiated immediately whenever any clearing, grading, excavating, or other earth disturbing activities have permanently ceased on any portion of the site or temporarily ceased on any portion of the site and will not resume for 14 calendar days. In drought stricken areas and areas that have recently received such high amounts of rain that seeding with field equipment is impossible and initiating vegetative stabilization is infeasible, alternative stabilization measures must be employed as specified by the regulatory agency. In limited circumstances, stabilization may not be required if the intended function of a specific area of the site necessitates that it remain disturbed.
4. **Dewatering:** Discharges from dewatering activities, including discharges from dewatering trenches and excavations, are prohibited unless managed by appropriate controls.
5. **Pollution Prevention Measures:** Design, install, and maintain effective pollution prevention measures to minimize discharge of pollutants. At a minimum such measures must be designed, installed, and maintained to:
 - a. Minimize the discharge of pollutants from equipment and vehicle washing, wheel wash water, and other wash water. Wash waters must be treated in a sediment basin or alternative control that provides equivalent or better treatment prior to discharge.
 - b. Minimize the exposure of building materials, building products, construction wastes, trash, landscape materials, fertilizers, pesticides, herbicides, detergents, sanitary waste, and other materials present on the site to precipitation and stormwater. Minimization of exposure is not required in cases where the exposure to precipitation and to stormwater will not result in a discharge of pollutants, or where exposure of a particular material or product poses little risk of stormwater contamination, such as final products and materials intended for outside use.
 - c. Minimize the discharge of pollutants from spills and leaks and implement chemical spill and leak prevention and response procedures.
6. **Prohibited Discharges:** The following discharges are prohibited:
 - a. Wastewater from wash out and cleanout of stucco, paint, form release oil, curing compounds, and other construction materials.
 - b. Fuels, oils, and other pollutants used in vehicle and equipment operation and maintenance.
 - c. Soaps or solvents used in vehicle and equipment washing.
7. **Surface Outlets:** When discharging from basins and impoundments, utilize outlet structures that withdraw water from the surface, unless infeasible.

B. NPDES Construction Site Permitting

1. **Permit Requirements:** For construction projects, an NPDES permit from the Iowa DNR is required for any site that disturbs and exposes one acre of land or more. A permit is also required for projects that will disturb one or more acres as part of a common plan of development, even if there will not be one acre of disturbed ground exposed at any given time. In addition to the Iowa DNR, many local agencies also have a permit process. It is necessary to check with the Jurisdictional Engineer to determine what, if any, information is needed for the local agency permit.

An example of a common plan of development would be a property owner who has two acres of land that he plans to divide up into four half-acre lots. Even though each half-acre lot will be graded and sold off individually, an NPDES permit is required because the grading of the individual lot is part of an overall plan to grade and develop two acres of land.

Additional information regarding projects that require an NPDES permit can be obtained from the [Iowa DNR's website](#).

2. **Permitting Process:** For most construction projects, coverage under the NPDES program will be obtained from the Iowa DNR through General Permit No. 2. The steps required to obtain coverage under this permit are as follows:
- a. **Prepare a Stormwater Pollution Prevention Plan:** A Stormwater Pollution Prevention Plan (SWPPP) describes the site and identifies potential sources of pollution. The SWPPP also provides a description of the practices that will be implemented to mitigate erosion and sediment loss from the site. The SWPPP must be prepared prior to submittal of the Notice of Intent. Detailed information on the required SWPPP content is provided later in this section.
 - b. **Publish a Public Notice:** Arrange for publication of a public notice of stormwater discharge that states the applicant's intention to file a Notice of Intent for coverage under the General Permit No. 2. This notice must be published for at least one day in the one newspaper with the largest circulation in the area of the discharge. A link to Iowa DNR for a copy of a typical public notice is contained in the Appendix.
 - c. **Notice of Intent:** Complete and sign a "Notice of Intent for NPDES Coverage Under General Permit" form. Note that there are specific restrictions on which individuals are authorized to sign the Notice of Intent (NOI). The Notice of Intent must be signed by an authorized individual (see Part VI.G of the NPDES permit for a list of individuals authorized to sign the permit). Also note that that the form contains an area to fill in information for a contact person. This is the person to whom all future correspondence will be sent. This person does not need to be the owner or other authorized signatory, but should be a person who will be involved with the project for the duration of the permitting period. A link to Iowa DNR for a Notice of Intent is contained in the Appendix.

Acceptable proof of publication consists of an affidavit from the publisher or a newspaper clipping of the NOI that includes the date of publication and newspaper name.

Construction may not be initiated until the Iowa DNR issues a construction authorization.

- d. **Notice of Discontinuation:** The final step in the NPDES General Permit No. 2 process is to file a Notice of Discontinuation (NOD) with the Iowa DNR. The NOD ends the coverage of the site under the permit, relieving the permittees from the responsibilities of the permit and the possibility of enforcement actions against the permittees for violating the requirements of the permit.

An NOD should be filed with the Iowa DNR within 30 days after the site reaches final stabilization. Final stabilization means that all soil-disturbing activities are completed, and that a permanent vegetative cover with a density of 70% or greater has been established over the entire site. It should be noted that the 70% requirement does not refer to the percent of the site that has been vegetated (i.e. 7 out of 10 acres). In order to file a Notice of Discontinuation, 100% of the disturbed areas of the site must be vegetated. The density of the vegetation across the site must be at least 70% and sufficient to preclude erosion from the entire site. The NRCS Line-Transect method can be used to determine vegetation density if actual measurements are required.

Like the Notice of Intent, the Notice of Discontinuation must be signed by an authorized individual and must contain a specific certification statement. A link to Iowa DNR for a Notice of Discontinuation is provided in the Appendix.

- e. **Local Requirements:** As part of the NPDES regulations, some communities are required to review SWPPPs for land-disturbing activities that occur within their communities. Other communities may have elected to pass erosion and sediment control ordinances that must be adhered to. The designer should check with the local jurisdiction to determine if local requirements exist.
3. **Compliance with NPDES General Permit No. 2:** Once a Notice of Intent has been filed, activities at the site must comply with the requirements of NPDES General Permit No. 2. These requirements include:
 - a. Implement pollution prevention practices as detailed on the SWPPP.
 - b. Maintain the SWPPP and keep it current by noting significant changes.
 - c. Inspecting the site and pollution prevention measures at the required intervals.
 - d. Contractors and subcontractors, identified in the SWPPP, are required to sign on as co-permittees.
 - e. Note changes of ownership or transfer of the permit responsibilities.
 - f. If there is a construction trailer, shed, or other covered structure located on the property, retain a copy of the SWPPP required by this permit at the construction site from the date of project initiation to the date of final stabilization. If there is no construction trailer, shed, or other covered structure located on the property, retain a copy of the plan from the date of project initiation to the date of final stabilization at a readily available alternative site approved by Iowa DNR and provide it for inspection upon request.
 - g. Retain copies of the SWPPP and all reports required by this permit, and records of all data used to complete the Notice of Intent covered by this permit, for a period of at least 3 years from the date that the site is finally stabilized and a Notice of Discontinuation has been submitted to Iowa DNR.

C. Stormwater Pollution Prevention Plans (SWPPP)

1. **Purpose:** The NPDES General Permit No. 2 requires that a Stormwater Pollution Prevention Plan (SWPPP) be developed. The practices described in the SWPPP designed to reduce contamination of stormwater that can be attributed to activities on a construction site. Construction creates the potential for contamination of stormwater from many different sources. Grading removes protective vegetation, rock, pavement, and other ground cover, exposing the soil to the elements. This unprotected soil can erode and be carried off by stormwater runoff to lakes and streams. In addition, construction often involves the use of toxic or hazardous materials such as petroleum products, pesticides and herbicides, and building materials such as asphalt, sealants, and concrete, which may pollute stormwater running off of the site.

The SWPPP must clearly identify all potential sources of stormwater pollution and describe the methods to be used to reduce or remove contaminants from stormwater runoff.

The SWPPP is not intended to be a static document; rather it must be updated as necessary to account for changing site conditions that have a significant impact on the potential for stormwater contamination. The SWPPP must also be revised if the current plan proves to be ineffective at significantly minimizing pollutants.

2. **Preparation of a SWPPP:** The individual preparing the SWPPP should have a thorough understanding of the project and the probable sequence of construction operations.

The process of preparing a SWPPP should begin by reviewing the existing site, and identifying the work required to complete the desired improvements. Next, the project should be broken down into major components or phases (e.g. clearing, grading, utility work, paving, home building, etc.). The specific phasing may vary for each project, depending on the scope of the work. On large projects with multiple areas that will be completed in stages, each stage of construction should be broken down separately.

Next, a system of erosion and sediment controls should be designed for each phase of construction. The system of controls should take into account the anticipated condition of the site during each stage. For example, at the end of the grading phase, it is likely that the entire site will be stripped and highly vulnerable to erosion; temporary seeding and/or other stabilization practices may be the major control employed at this stage. At the end of the utility phase, the site may now have storm sewer and other drainage structures installed. This creates a direct route for sediment-laden runoff to easily leave the site. Implementing sediment retention may be an important control at this stage.

An individual erosion or sediment control practice should not be utilized as the sole method of protection. Each phase of construction should incorporate multiple erosion and sediment control practices. Utilizing a variety of both erosion control and sediment control practices is an effective and efficient method of preventing stormwater pollution.

Once the phasing has been determined, and the methods of protection have been selected, a SWPPP can be developed. The following section summarizes the elements of a SWPPP that are required by General Permit No. 2.

3. **Required Content of the SWPPP:** Part IV of the Iowa DNR NPDES General Permit No. 2 contains a description of the specific items that must be included within the SWPPP. A summary of those items is provided below.
 - a. **Site Description:** The first step in preparing a SWPPP is to provide a detailed description of the site. This description must include the following items:
 - 1) The nature of the construction activity (e.g. roadway construction, utility construction, single family residential construction, etc.) and major soil-disturbing activities (i.e. clearing, grading, utility work, paving, home building, etc.).
 - 2) An estimate of the total area of the project site and the area that is expected to be disturbed by construction.
 - 3) An estimate of the runoff coefficient for the site after construction (See Chapter 2 - Stormwater for determination of runoff coefficients).
 - 4) A summary of available information describing the existing soil and soil properties (e.g. type, depth, infiltration, erodibility, etc.).
 - 5) Information describing the quality of the stormwater runoff currently discharged from the site (required only if data exists, it is not necessary to collect and analyze runoff).
 - 6) The name of the receiving waters and ultimate receiving waters of runoff from the site. If the site drains into a municipal storm sewer system, identify the system, and indicate the receiving waters to which the system discharges.
 - 7) A site map that includes limits of soil-disturbing activities, existing drainage patterns, drainage areas for each discharge location (including off-site drainage), proposed grading, surface waters and wetlands, and locations where stormwater is discharged to surface water.
 - 8) Approximate slopes after major grading activities.

- 9) The location of structural and nonstructural controls.
 - 10) The location of areas where stabilization practices are expected to occur.
- b. Controls:** The plan needs to show what erosion and sediment controls and stormwater management practices will be used to reduce or eliminate contamination of stormwater by pollutants.
- 1) **Sequence:** List the anticipated sequence of major construction activities and clearly describe the order for implementation of the control measures. It is not necessary to list anticipated dates for completion of the various stages of construction and implementation of practices; rather the SWPPP should indicate the stage of construction at which individual control measures are to be installed.
 - 2) **Stabilizing Practices:**
 - Describe the temporary and permanent stabilizing practices (protection of existing vegetation, surface roughening, seeding, mulching, compost blankets, Rolled Erosion Control Products (RECPs), sod, vegetative buffer strips, etc.).
 - Note that areas not subject to construction activity for 14 calendar days or more must have stabilizing measures initiated immediately after construction activity has ceased.
 - 3) **Structural Practices:**
 - Describe any structural practices that will be used to divert flows away from disturbed areas, store runoff, limit erosion, or remove suspended particles from runoff (silt fence, filter socks, diversion structures, sediment traps, check dams, slope drains, level spreaders, inlet protection, rip rap, sediment basins, etc.).
 - For sites with more than 10 acres disturbed at one time, which drain to a common location, a sediment basin providing 3,600 cubic feet of storage per acre drained is required where attainable. When sediment basins of the size required are not attainable, other methods of sediment control that provide an equivalent level of protection are required.
 - For disturbed drainage areas smaller than 10 acres, a sediment basin or sediment control along the sideslope and downslope boundaries of the construction area is required. The sediment basin should provide 3,600 cubic feet of storage per acre drained.
 - Unless infeasible, the following measures should be implemented at all sites: utilize outlet structures that withdraw water from the surface when discharging from basins, provide and maintain natural buffers around surface waters, and direct stormwater to vegetated areas to both increase sediment removal and maximize stormwater infiltration.
 - According to General Permit No. 2 Part IV.D.2.A.(2).(c), the permittee(s) shall minimize soil compaction and, unless infeasible, preserve topsoil. "Infeasible" shall mean not technologically possible, or not economically practicable and achievable in light of the best industry practices. "Unless infeasible, preserve topsoil" shall mean that, unless infeasible, topsoil from any areas of the site where the surface of the ground for the permitted construction activities is disturbed, shall remain within the area covered by the applicable General Permit No. 2 authorization. Minimizing soil compaction is not required where the intended function of a specific area of the site dictates that it be compacted. Preserving topsoil is not required where the intended function of a specific area of the site dictates that the topsoil be disturbed or removed. The permittee(s) shall control stormwater volume and velocity to minimize soil erosion in order to minimize pollutant discharges and shall control stormwater discharges, including both peak flowrates and total stormwater volume, to minimize channel and streambank erosion and scour in the immediate vicinity of discharge points. An affidavit signed by the permittee(s) may be submitted to demonstrate compliance.

- For construction activity that is part of a larger common plan of development, such as a housing or commercial development project, in which a new owner agrees in writing to be solely responsible for compliance with the provisions of this permit for the property that has been transferred or in which the new owner has obtained authorization under this permit for a lot or lots (as specified in subrule 567-64.6(6) of the Iowa Administrative Code), the topsoil preservation requirements described above must be met no later than at the time the lot or lots have reached final stabilization as described in this permit.
 - In residential and commercial developments, a plat is considered a project. For other large areas that have been authorized for multiple construction sites, including those to be started at a future date such as those located at industrial facilities, military installations, and universities, a new construction project not yet surveyed and platted out is considered a project. This stipulation is intended to be interpreted as requiring the topsoil preservation requirements on development plats and construction activities on other extended areas that may have several construction projects allowed under the same authorization to be implemented on those projects not yet surveyed and platted out prior to October 1, 2012, even if other plats and construction activities in the same development or other extended area were authorized prior to October 1, 2012.
- 4) Stormwater Management:**
- Describe the features that will be installed during construction to control pollutants in stormwater after construction operations are completed.
 - Pollutant removal features may include detention/retention ponds, vegetated swales, and infiltration practices.
 - Post-construction erosion control features may include channel protection/lining and velocity dissipation at outlets.
- 5) Other Controls:**
- Note in the SWPPP that any waste materials from the site must be properly disposed of.
 - Describe practices for preventing hazardous materials that are stored on the site from contaminating stormwater.
 - Describe a method to limit the off-site tracking of sediment by vehicles.
 - Define construction boundaries to limit the disturbance to the smallest area possible.
 - Identify areas to be preserved or left as open space.
- 6) State and Local Requirements:**
- List additional state or local regulations that apply to the project. Note that some local jurisdictions may have an erosion and sediment control ordinance. The requirements of this ordinance must be listed in the SWPPP.
 - List any applicable procedures or requirements specified on plans approved by state or local officials.
 - Section 161A.64 of the Code of Iowa requires that prior to performing any “land-disturbing” activity (not including agricultural activities) in a city or county that does not have an erosion control ordinance and a 28E agreement with the Soil and Water District, a signed affidavit must be filed with the local Soil and Water Conservation District stating that the project will not exceed the soil loss limits stated. It should be noted that this requirement is not a condition of the NPDES General Permit No. 2.
- c. Maintenance:** The SWPPP must describe the maintenance procedures required to keep the controls functioning in an effective manner. For each type of erosion or sediment control practice utilized, a description of the proper methods for maintenance must be provided. In addition, maintenance should include removal of sediment from streets, ditches, or other off-site areas.

- d. Inspections:** The SWPPP must describe the inspection requirements of General Permit No. 2. Inspections are required every 7 calendar days. Check local agency regulations for permit inspection and reporting requirements. The inspections must include the following:
- 1) Inspect disturbed areas and areas used for storage of materials for evidence of pollutants leaving the site and/or entering the drainage system.
 - 2) Inspect erosion and sediment control measures identified in the SWPPP to ensure they are functioning correctly.
 - 3) Inspect discharge locations to ascertain if the current control measures are effective in preventing significant impacts to the receiving waters.
 - 4) Inspect locations where vehicles enter/exit the construction site for signs of sediment tracking.
 - 5) Prepare an inspection report that lists the date, the name of the inspector, and the inspector's qualifications. The report must summarize the inspection and note any maintenance of the controls or changes to the SWPPP that are required.
 - 6) Implement required maintenance or changes to the SWPPP identified during the inspection as soon as practicable after the inspection, but no more than seven calendar days following the inspection. If the permittee determines that making these changes at the construction site or to the plan less than 72 hours after the inspection is impracticable, the permittee shall document in the plan why it is impracticable and indicate an estimated date by which the changes will be made.

The Project Engineer should note that SUDAS Specifications Section 9040 provides for two bid items related to the SWPPP. The first relates to the Contractor preparing the SWPPP. The second bid item involves management of the SWPPP, which includes the actions necessary to comply with the General Permit No. 2, conduct regular inspections, documentation, updates to the SWPPP, and filing of the Notice of Discontinuation.

- e. Non-stormwater Discharges:** Various non-stormwater related flows are allowed to be discharged into the stormwater system, provided that they are not contaminated by detergents or spills/leaks of toxic/hazardous materials. Allowable non-stormwater discharges include flows from fire hydrant and potable waterline flushing, vehicle washing, external building washdown that does not use detergents, pavement washwater where spills or leaks of toxic or hazardous materials have not occurred, air conditioning condensate, springs, uncontaminated groundwater, and footing drains. When there is a possibility for these types of discharges on the site, they must be identified in the SWPPP and include a description of the measures that will be implemented to prevent these flows from becoming contaminated by hazardous materials or sediment.
- f. Contractors:** The SWPPP must clearly identify all of the contractors or subcontractors that will implement each measure in the plan. Each contractor or subcontractor identified is required to sign a certification statement making them a co-permittee with the owner and other contractors. The certification must read as follows:

"I certify under penalty of law that I understand the terms and conditions of the general National Pollutant Discharge Elimination System (NPDES) permit that authorizes the stormwater discharges associated with industrial activity from the construction site as part of this certification. Further, by my signature, I understand that I am becoming a co-permittee, along with the owner(s) and other contractors and subcontractors signing such certifications, to the Iowa Department of Natural Resources NPDES General Permit No. 2 for "Storm Water Discharge Associated with Industrial Activity for Construction Activities" at the identified site. As a co-permittee, I understand that I, and my company, am legally required under the Clean Water Act and the Code of Iowa, to ensure compliance with the terms and

conditions of the stormwater pollution prevention plan developed under this NPDES permit and the terms of this NPDES permit.”

Under most circumstances, the identity of the contractor and any subcontractors implementing the pollution prevention measures will not be known at the time of SWPPP preparation. The SWPPP should provide a blank certification form and a location to identify who will be responsible for implementing each pollution prevention measure. The contractor responsible for maintaining the SWPPP can then complete this information, as it becomes available.

D. Who is Responsible

- 1. Property Owner:** Coverage under the NPDES General Permit No. 2 is granted to the property owner. The property owner has the ultimate responsibility for ensuring that the conditions of the permit are met. Enforcement actions associated with non-compliance with the permit are normally directed against the property owner.
- 2. Designer:** The project designer typically prepares the initial SWPPP, although the contractor may be required to develop the SWPPP and obtain the NPDES permit if so directed in the contract documents. The designer may continue to review and approve changes to the SWPPP (on behalf of the owner).
- 3. Jurisdiction:** On public improvement projects, the Jurisdiction serves as the owner of the site (see requirements for owners above).

According to Iowa DNR regulations, certain MS4 jurisdictions are required to conduct inspections on public construction projects that require coverage under an NPDES permit. Under most circumstances, these inspections must be conducted utilizing the MS4's own staff. The contractor is not allowed to perform these inspections. The purpose of these inspections is to ensure that contractors are correctly implementing the BMPs identified in the SWPPP and to ensure that the jurisdiction maintains an active role in preventing stormwater contamination from its public improvements projects.

The inspections by the jurisdiction must be conducted every 7 days. These jurisdictional inspections may also be used to satisfy the inspection requirements of the NPDES General Permit No. 2.

The preparer of the SWPPP should check with the local jurisdiction for additional review and permitting requirements.

- 4. Contractor/Builder:** Contractors and builders that are involved in implementing any of the measures identified for controlling pollution of stormwater runoff must sign on as a co-permittee with the owner. As a co-permittee, the contractor is required to comply with all of the requirements of the NPDES permit.

In addition, most owners will contractually assign all responsibility for compliance with the NPDES permit to the contractor. Under this situation, any fines levied against the owner will normally be passed along to the contractor.

E. Transfer of Ownership and Responsibilities

On many construction projects, such as private residential subdivisions or commercial developments, it is common for a developer to sell off individual lots before work on the entire subdivision is complete. Coverage under General Permit No. 2 cannot be discontinued for individual portions of a project; the permit requires that the entire project reach final stabilization before a Notice of Discontinuation can be filed, and coverage for the entire site terminated. This creates a situation where the developer and any co-permittees are responsible for compliance with the permit for land they no longer own or have control over.

A provision within the Iowa Administrative Code [567 IAC 64.6(6)(b)] addresses this situation. This provision allows the developer and new property owner to become co-permittees under the NPDES permit. This provision requires that the new owner be notified, in writing, of the existence and location of the permit and the SWPPP and of their responsibility to comply with the permit.

This provision within the Code also allows the new owner to accept sole responsibility for compliance with the permit for the transferred property. This transfer of responsibility requires written acknowledgement by the new owner that they accept responsibility for complying with the permit for the property in question.

A copy of all property transactions, notifications of coverage, and transfer of responsibility agreements must be included with the SWPPP.

The Erosion and Sedimentation Process

Erosion and sedimentation are naturally occurring processes. However, human activities have accelerated these processes well beyond the rate desired by nature. The removal of large volumes of soil from the land, and their deposition in waterways, has destroyed ecosystems and degraded the environment.

In order to minimize and control erosion and sedimentation, it is important to understand the process and cause of each.

A. The Erosion Process

1. **Water:** Erosion from water typically occurs in the following ways:

- a. **Raindrop Splash and Sheet Erosion:** The first step in the erosion process begins as raindrops impact the soil surface. Raindrops typically fall with a velocity of 20 to 30 feet per second. The energy of these impacts is sufficient to displace soil particles as high as two feet vertically. In addition, the impact of rainfall on bare soil can compact the upper layer of soil, creating a hard crust that inhibits plant establishment and infiltration.

Sheet erosion occurs as runoff travels over the ground, picking up and transporting the particles dislodged by raindrop impacts. The process of sheet erosion is uniform, gradual, and difficult to detect until it develops into rill erosion. If runoff is maintained as sheet flow, the velocity remains low and there is little potential that the flow will remove particles that have not been dislodged by other means (i.e. raindrop splash).

The method used to prevent erosion from raindrop splash and sheet erosion is stabilization. Stabilizing techniques such as temporary and permanent vegetation, sodding, mulching, compost blankets, and rolled erosion control products absorb the impact of raindrops and protect the ground surface. By protecting the surface, soil particles are not dislodged and transported by sheet flow. Typically, sheet flow does not have sufficient volume or velocity to dislodge soil particles from a bare surface by itself. It is dependent on raindrop impacts to disturb the surface. Therefore, stabilizing a surface protects the ground from both raindrop and sheet erosion.

- b. **Rill Erosion:** Rill erosion occurs as runoff begins to form small concentrated channels. As rill erosion begins, erosion rates increase dramatically due to the resulting higher velocity concentrated flows. Construction sites that show signs of rill erosion need to be re-evaluated and additional erosion control techniques employed. Rilling can be repaired by tilling or disking (filling in the rills and discouraging concentrated flows) and should be repaired as soon as possible in order to prevent gullies from forming.
- c. **Gully Erosion:** Gully erosion results from water moving in rills, which concentrates to form larger channels. When rill erosion can no longer be repaired by merely tilling or disking, it is defined as gully erosion. Gullies must typically be repaired with earthmoving equipment. Gully erosion can be prevented by quickly repairing rill erosion and addressing the cause of the rill erosion.

- d. **Stream Channel Erosion:** Stream channel erosion consists of both streambed and streambank erosion. Streambed erosion occurs as flows cut into the bottom of the channel, making it deeper. This erosion process will continue until the channel reaches a stable slope. The resulting slope is dependent on the channel materials and flow properties.

As the streambed erodes and the channel deepens, the sides of the channel become unstable and slough off, resulting in streambank erosion. Streambank erosion can also occur as soft materials are eroded from the streambank or at bends in the channel. This type of streambank erosion results in meandering waterways.

One significant cause of both streambed and streambank erosion is the increased frequency, volume, and duration of runoff events that are a result of urban development.

Figure 7C-1.01: Types of Soil Erosion by Water

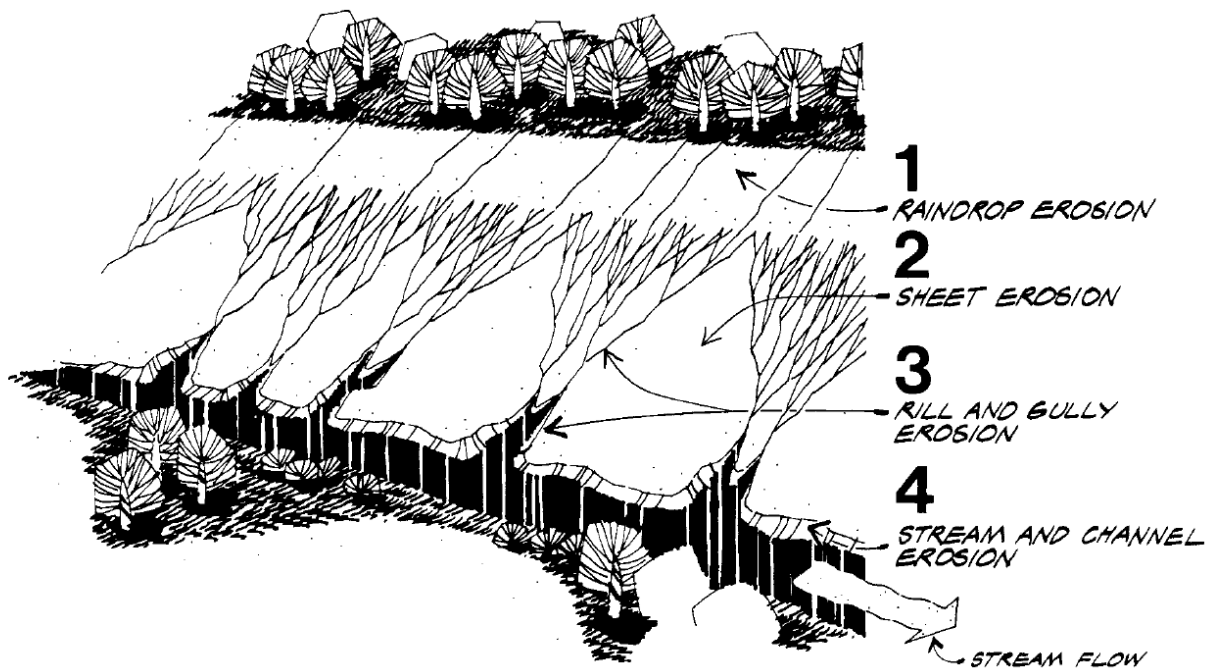

Source: USDA NRCS, 2002

2. **Wind:** Wind can also detach soil particles. Detached soil is moved by wind in one of three ways:
- Suspension:** Very fine silt and clay particles (smaller than 0.002 inches in diameter) may be picked up by the wind and carried in suspension. Suspended dust may be moved great distances, but does not drop out of the air unless rain washes it out or the velocity of the wind is dramatically reduced.
 - Saltation:** Fine silts up to medium sand particles (0.002 to 0.02 inches in diameter) move in the wind in a series of steps, rising into the air and falling after a short flight. This movement is called saltation. A vast majority of wind erosion is a result of the saltation process.
 - Creep:** Soil particles larger than medium sands (greater than 0.02 inches) cannot be lifted into the wind, but particles up to 0.04 inches (coarse sand) may be pushed along the soil surface by saltating grains or direct wind action. This action is called creep.

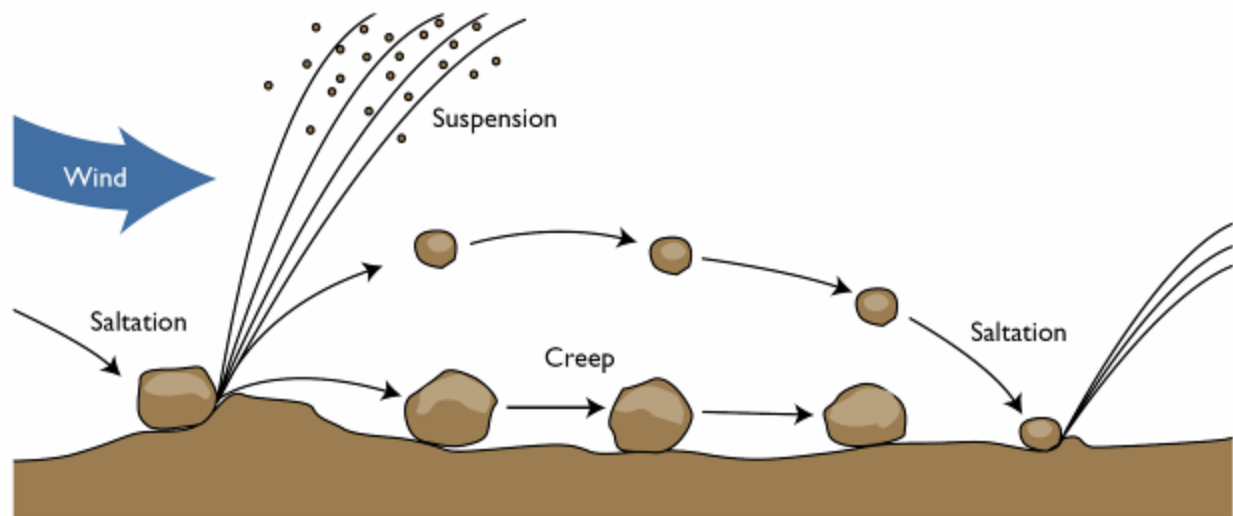
Figure 7C-1.02: Movement of Soil Particles by Wind Erosion

Source: McCauley & Jones, 2005

B. Factors Affecting Erosion

The extent of erosion that occurs is dependent on a number of factors including soil erodibility, climate, vegetative cover, topography, and season.

1. **Soil Erodibility:** The erodibility of a soil depends on its texture and physical properties. The characteristics that influence the potential for erosion are those related to the infiltration capacity of the soil and its ability to resist detachment. Soil properties that affect erodibility include texture, organic matter content, soil structure, and permeability.

In general, soils with a high percentage of fine sand and silt are the most erodible. These particles are easily detached and carried away by rainfall and runoff. As the clay and organic content of a soil increases, the erodibility of the soil tends to decrease.

Clay particles have the ability to bind together, reducing the potential for detachment by raindrop splash. However, they are also more impermeable, resulting in increased runoff. The increase in runoff increases the erosion potential (especially rill and gully), offsetting some of the benefit that the binding effect has against resisting erosion. The problem with clay particles is that once they have eroded, they are easily transported by water and are very difficult to remove.

Soils that are high in organic matter content have a more stable texture and increased permeability. This allows the soil to resist detachment and infiltrate more precipitation. Well-draining sands and gravels are the least erodible soils. Soils with high infiltration rates such as these significantly reduce the amount of runoff, thereby reducing the potential for erosion.

The USDA county soil surveys provide an indication of soil erodibility. This value (K) ranges from 0 to approximately 0.7. Higher values indicate a greater potential for erosion.

2. **Precipitation:** The rate of erosion is directly related to the amount and type of precipitation that occurs. High intensity storms increase particle detachment. In addition, frequent or lengthy storms can saturate the soil, reducing infiltration and increasing runoff. Increased detachment and runoff both contribute to erosion. Erosion risks are high where precipitation is frequent,

intense, or lengthy. In Iowa, the wettest months occur between May and August, when construction activities are at their peak.

3. **Ground Cover:** Ground cover can significantly reduce erosion potential. Vegetative residue, mulch, and compost, as well as the leaves and branches of vegetation, intercept precipitation and shield the ground from raindrop impacts. The roots of vegetation help hold soil particles together and prevent them from becoming detached. Ground cover slows runoff velocity, increases infiltration, and can even filter sediment out of runoff.
4. **Topography:** Areas with long and/or steep slopes increase the potential for erosion. Long slopes increase the potential for runoff to accumulate and develop into erosive concentrated flow near the bottom of the slope. On steep slopes, high-velocity flows can develop quickly and cause significant erosion.
5. **Season:** The potential for erosion varies throughout the year. In winter months when the ground surface is frozen, there is little chance of water erosion. As spring approaches, the surface soils begin to thaw, but the ground below remains frozen. This creates a high potential for erosion. An early spring rain at this time cannot infiltrate into the frozen subsoils. However, the newly thawed surface can be easily washed away, even by a light rain. Erosion potential is also high in the summer months, due to the high-intensity thunderstorms that occur during this period.

C. Sediment Transportation

Once soil particles are detached from the surface and suspended in runoff waters, they will remain there until the velocity of the water is reduced. Flowing waters create turbulence that constantly churns and mixes the flow, holding the particle in suspension. In order for the particles to be removed, the velocity of the flow must be reduced sufficiently to allow the particle to settle out by gravity. This process is discussed in further detail in Section 7D-1 - Design Criteria.

Once sediment reaches a natural waterway or stream, it is nearly impossible to remove. As discussed above, the flowing nature of the stream holds the particles in suspension until the flow velocity is reduced. For natural waterways, this reduction in flow velocity does not normally occur until the waterway empties into a water body. At this point, the sediment settles out and is deposited on the bottom of the pond or lake. Over time, this sediment accumulates, forming large deposits and can eventually fill in a water body completely. Sediment is the largest pollutant (by volume) in stormwater runoff. The resulting deposits can destroy ecosystems and are difficult and expensive to remove.

Design Criteria

A. Introduction

Erosion and sediment control should be an integral part of every construction project. Preventing sediment from leaving construction sites is a major advancement toward improving water quality. The first step in erosion and sediment control for a construction project should begin with proper design. In order to effectively design erosion and sediment control measures, a distinction must be made between erosion control and sediment control; and the role of each defined.

The primary method of protecting a site should be preventing erosion. Erosion control measures protect the ground surface and prevent soil particles from being detached by the force of raindrop impact and concentrated flows. Sediment control practices focus on the removal of suspended particles from runoff after erosion has occurred. No sediment control structure is 100% effective, and removal of fine soil particles, which are very common in Iowa, is difficult. The best way to improve the efficiency of sediment control structures is to prevent erosion in the first place.

Sediment control practices are generally more expensive and less effective than providing proper erosion control. While sediment control structures can remove significant amounts of sediment from stormwater runoff, and should be implemented as part of the overall erosion and sediment control plan, they should be considered secondary to erosion control for the reasons described above.

Figure 7D-1.01: Sediment in Street Due to Inadequate Erosion and Sediment Control During Construction



Source: USDA NRCS Photo Gallery

B. Erosion Control

The key to successful erosion and sediment control on construction sites is the prevention of erosion. The simplest way to keep sediment from leaving a site is to keep it in place. The following site management methods should be implemented on all sites to help prevent erosion from occurring:

- 1. Limit Exposed Area:** Existing well-vegetated areas are usually stable and nearly erosion-proof. The simplest and cheapest way to prevent erosion on a site is to prevent the existing vegetation from being disturbed. Obviously, this cannot be done for areas that must be graded and some ground must be exposed. However, by carefully planning the construction, controlling staging and equipment storage areas, and marking construction limits, the exposed area can be minimized.
- 2. Limit Exposure Time:** Leave existing vegetation in place as long as construction operations allow to reduce the amount of time that a disturbed surface is exposed. If possible, stage construction so that one area is stabilized before grading activities begin on another area. After areas are disturbed, they should be stabilized as soon as possible. The NPDES permit contains specific requirements for initiating stabilization procedures once construction activities are completed or temporarily suspended. Stabilization activities may include temporary or permanent seeding, sodding, rolled erosion control products, turf reinforcement mats, compost blankets, or mulching.
- 3. Divert Runoff:** Sheet or concentrated flow over a disturbed area can cause severe erosion. For sites that receive upland runoff, diversion should be constructed to protect bare slopes until vegetation or stabilization is established. Methods of diverting runoff away from or over disturbed areas include diversion structures (berms and swales), slope drains, rock chutes, and flumes. Diverted runoff must be discharged to a stable outlet. A level spreader can be used to convert concentrated diverted flows to sheet flow before they are released onto stable ground.
- 4. Limit Velocity:** As runoff travels down a bare slope, its velocity increases. Limiting slope lengths will help prevent high-velocity flows. Where it is not practical to reduce the height of a slope by grading, the slope length can effectively be broken up into several smaller slopes by installing silt fence, filter berms, filter socks, and wattles. In ditches and channels, check dams should be used.
- 5. Protect Concentrated Flow Areas:** Concentrated flows will occur on most sites. As sheet flows converge and the volume increases, the flow eventually becomes concentrated and provisions must be made to prevent erosion. Grass channels can carry some concentrated flow. Rolled erosion control products and turf reinforcement mats can provide additional reinforcement when required. At discharge points, rock outlet protection or flow transition mats can be provided to dissipate energy and prevent scour at the outlet.

C. Calculating Soil Loss

Regardless of the stabilizing and vegetative practices employed, inevitably some soil erosion will occur. Over the years, a variety of different models have been developed to estimate the amount of erosion that occurs on a given site. The current model utilized by the National Resource Conservation Service (NRCS) is the second revision of the Uniform Soil Loss Equation (USLE) which is called RUSLE2 (Revised Universal Soil Loss Equation). RUSLE2 is a semi-empirical model that considers the erodibility factors discussed in the previous section. The RUSLE2 model utilizes the following equation to determine sediment delivery rate:

$$A = R \times K \times L \times S \times C \times P \quad \text{Equation 7D-1.01}$$

Where:

- A = Estimated average annual soil loss in tons/acre/year
- R = Rainfall-runoff erosivity factor
- K = Soil erodibility factor
- L = Slope length factor
- S = Slope steepness factor
- C = Cover management factor
- P = Support practice factor

Manually calculating soil loss with the RUSLE2 model is a time-consuming process that requires extensive weather, soils, and other support information. In order to simplify the use of RUSLE2, NRCS has developed a RUSLE2 software program. The RUSLE2 program utilizes the concept described above to estimate soil loss, sediment yield, and sediment characteristics from sheet and rill erosion. This program is available for download from NRCS at:

http://fargo.nserl.purdue.edu/rusle2_dataweb/RUSLE2_Index.htm.

While the RUSLE2 model was originally developed to analyze conservation practices on agricultural land, it can also be used to estimate sediment delivery rates from construction sites. This is an especially useful tool for designing erosion and sediment control systems for large sites. It is also useful for estimating sediment delivery rates to both temporary and permanent sediment basins. This information can be used to estimate the required cleanout frequency for sediment control structures, and for identifying sites that are highly susceptible to erosion, so potential problems can be addressed prior to construction.

D. Sediment Removal

1. **Sediment Control Devices:** Eroded soil particles that are suspended in flowing runoff waters will be transported offsite unless they are removed. The simplest and most efficient way to remove suspended particles from runoff is by detaining the runoff to slow the flow velocity; thereby allowing the suspended soil particles to settle out. This is most commonly accomplished with a sediment control device.

The most important factor in designing a sediment control device is selecting the appropriate size. The ideal situation would be to collect and retain all runoff in a large retention structure, preventing any contaminated water from leaving the site. However, this is not practical in most situations. First, to retain all water onsite would require large storage areas and volumes. In addition, the retained runoff would be required to infiltrate into the ground or evaporate. These processes may not be sufficient to remove all of the runoff before the next storm occurs.

A more practical approach is to size a device to detain the runoff for a sufficient time to remove a significant portion of the suspended material, yet allow the structure to outlet excess runoff, rather than retaining it. Since the device is allowed to drain both during and after the storm event, the size can be reduced, and the danger of being flooded out by a subsequent storm event is also reduced.

- 2. Designing Major Sediment Control Devices:** For a major sediment control device such as sediment basin or sediment trap to perform efficiently, it must be large enough to detain the contaminated runoff for a sufficient time to allow suspended particles to settle out, allow a sufficient flow of water through the system to prevent flooding, and be small enough that it is cost-effective to construct. In order to size an efficient basin, an understanding of the physics involved in removing suspended soil particles is required.

- a. Settling Velocity of Suspended Particles:** Particles suspended within a fluid will settle due to the force of gravity according to Stoke's Law. In summary, Stoke's Law states that a particle suspended within a fluid will fall at a constant vertical velocity, or settling velocity. The settling velocity is reached when the force of gravity acting on the particle equals the fluid resistance acting on the particle. The settling velocity of a suspended particle (assumed to be spherical) falling through water can be expressed as:

$$V_s = \frac{[g \times (G_s - 1) \times d^2]}{(18 \times \mu)} \quad \text{Equation 7D-1.02}$$

Where:

V_s = Settling velocity (ft/sec)
 g = Acceleration of gravity (32.2 ft/sec²)
 μ = Kinematic viscosity (ft²/sec²)
 G_s = Specific gravity of a particle
 d = Diameter of a particle (ft)

- b. Soil Types and Properties:** The size required for a sediment control structure to be effective depends greatly on the properties of the suspended soil particles that must be removed. Soil particles settle at different rates based upon their diameter and specific gravity. Larger particles will settle out according to Stoke's Law, as described above. However, very small particles, such as colloidal clay particles and fine silts have extremely slow settling velocities.

Capturing these small particles with a sediment control device may be impractical due to the extremely large structure size required to provide the long detention time required. Clay particles in particular, may never settle and remain suspended indefinitely due to Brownian Movement, which is a result of negatively charged particles repelling each other.

A sediment control device is designed around a design-size particle. The device is designed to remove 100% of soil particles that are design-size or larger. The design-size particle selected should be based upon the smallest soil particles that are present on the site to be disturbed.

Based upon the practical limitations discussed above, design-size particle selected to size the structure may normally be limited to medium silts or larger. For sites with fine silts and clay, which are smaller than the size used to design the structure, only a partial removal of these suspended fines can be expected. Because of this, additional efforts to prevent erosion should be utilized. The following table lists common settling velocities for various soil types.

Table 7D-1.01: Typical Soil Particle Settling Velocities

Particle	Diameter (ft)	Settling Velocity @ 60° F (ft/sec)
Fine Silt	3.3×10^{-5}	2.62×10^{-4}
Medium Silt	6.6×10^{-5}	1.02×10^{-3}
	9.8×10^{-5}	2.26×10^{-3}
Coarse Silt	1.3×10^{-4}	4.00×10^{-3}
	1.6×10^{-4}	6.27×10^{-3}
	2.0×10^{-4}	9.02×10^{-3}
Very Fine Sand	2.3×10^{-4}	0.012
	2.6×10^{-4}	0.016
	3.0×10^{-4}	0.020
	3.3×10^{-4}	0.025
	3.6×10^{-4}	0.030
	3.9×10^{-4}	0.036
Fine Sand	4.3×10^{-4}	0.042
	4.6×10^{-4}	0.049
	4.9×10^{-4}	0.056
	5.2×10^{-4}	0.064
	5.6×10^{-4}	0.073
	5.9×10^{-4}	0.081
	6.2×10^{-4}	0.091
	6.6×10^{-4}	0.100

Source: Adapted from Fifield, 2001

- c. **Major Sediment Control Device Sizing:** Soil particles are held in suspension by the turbulence associated with high flow velocities. In order to force suspended particles to settle out at a desired location, it is necessary to reduce the velocity of the runoff. Sediment control devices achieve this by increasing the cross-sectional area of the flow.

Based upon the settling velocity of the design-size soil particle and the outflow rate from the structure, the required surface area of the device can be calculated with the following equation:

$$SA = (1.2) \times \frac{(100 \times Q_{out})}{V_s} \quad \text{Equation 7D-1.03}$$

Where:

- SA = Surface area of sediment control device (ft²)
 Q_{out} = Discharge (ft³/s)
 V_s = Settling velocity of design particle (ft/sec)

The discharge rate from the device is the peak release rate for a 2 year, 24 hour storm. This rate is dependent on the drawdown time and outlet configuration. Refer to the information in Sections 7E-12 and 7E-13 on sediment basins and sediment traps for determining the configuration of the release structure and the drawdown time.

The equation above includes a safety factor of 1.2 as recommended by the EPA. This factor increases the minimum surface area by 20% to compensate for disturbances in uniform flow caused by wind, rain, wave action, and turbulence at the outlet structure.

The above equation for determining the size of a sediment control device is independent of depth. The reason the size is independent of depth can best be explained by the figures below. Particles that reach the bottom of the device prior to the overflow point are considered captured and should remain within the device. In the figures below, as the depth of the device is doubled (assuming the surface area remains constant), the suspended particles must travel twice as far to reach the bottom of the device. However, since the volume of storage is twice that of the first figure, the flow velocity through the device is only half that of the first and the particles have twice as much time to settle.

Figure 7D-1.02: Example of the Relationship Between Settling Time and Structure Volume

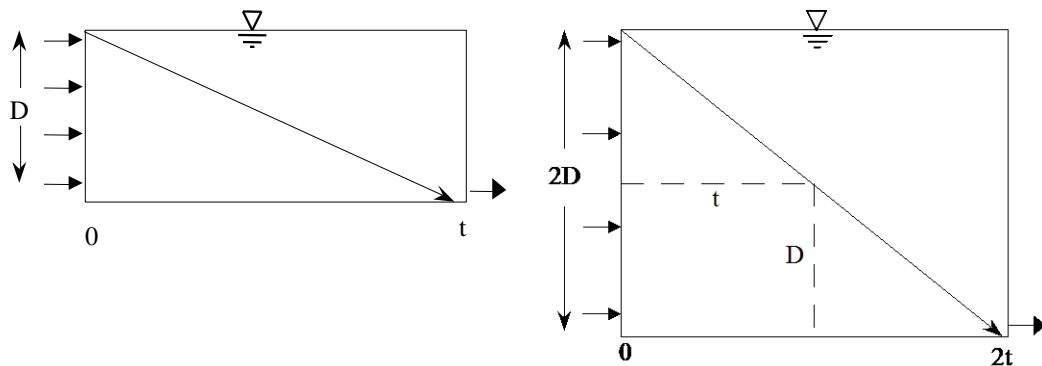

While theory may suggest that any depth is sufficient, field experience has shown that a minimum depth of 2 feet is required to account for actual conditions. This depth helps eliminate dead zones and short-circuiting, where inflows simply pass straight through the device without spreading out, reducing their velocity, and dropping the suspended sediment. This minimum depth also provides sufficient volume for a deposition zone, reducing cleanout frequency. Additional depth should be provided near the upstream end of the device. This provides an area for heavier particles to be trapped while maintaining the deposition area for smaller sized particles. Permanent sediment control devices should have a minimum depth greater than 2 feet in order to reduce the cleanout frequency.

Based upon field experience and practical limitations, a minimum depth of 2 feet can be applied to Equation 7D-1.04 to determine the minimum storage volume required.

$$SV = (2.4) \times \left(\frac{Q_{out}}{V_s} \right)$$

Equation 7D-1.04

Where:

SV = Storage volume (ft³) (volume of dry storage)

Q_{out} = Discharge (ft³/s) (peak discharge for a 2-yr, 24-hr storm)

V_s = Settling velocity of design particle (ft/sec)

d. Device Shape: The shape of the sediment control device is also important. The longer the flow path is for a particle through a device, the better the chances are that it will be captured. In addition, longer devices provide more area for deposition away from the turbulence of the inlet and outlet. A length to width ratio of 10:1 is recommended. The minimum length to width ratio should be 2:1.

- 3. Major Sediment Control Device Requirements:** While the discussion above provides a background on the concept and theory behind designing a sediment control device, the EPA has established its own minimum standards that must be met. The following summary of recommended design standards meet or exceed the EPA's regulations and should be followed for sediment basin and sediment trap design.

Sediment basins are required for disturbed areas greater than 10 acres, which drain to a common location. Sediment basins must be sized to provide a minimum storage volume of 3,600 cf of storage per acre drained. The storage requirement does not apply to flows from undisturbed areas or stabilized areas that have been diverted around the sediment basin.

For disturbed areas greater than 10 acres where a sediment basin designed according to the guidelines above is not feasible, smaller sediment basins or sediment traps should be used in conjunction with other erosion and sediment control practices as required to provide equivalent protection.

The storage volume provided for a sediment basin or sediment trap should be split equally between wet and dry storage. Wet storage is that volume which is below the embankment area and has a permanent pool. Dry storage is the volume that is detained by the release structure, but eventually released.

The following additional criteria should be provided for sediment control structures:

- a. A minimum length to width ratio of 2:1 (10:1 desirable) should be provided.
- b. A minimum depth of 2 feet from bottom of basin to overflow elevation (deeper structure recommended to reduce cleanout frequency).
- c. Side slopes 2:1 or flatter.

- 4. Minor Sediment Control Devices:** For areas where a major sediment control device such as a sediment basin or sediment trap, are not required or cannot be utilized, minor sediment control devices and measures should be provided. These measures provide the last line of defense against releasing sediment-laden stormwater runoff from a construction site. Minor sediment control devices that remove sediment from flow include vegetative filter strips, filter berms, filter socks, silt fence, and inlet protection.

Other measures that control sediment include stabilized construction entrances, which help prevent track out into streets; flocculents, which help remove suspended particles from standing water; and flotation silt curtains, which are used for construction within or near a water body.

Design Information for Erosion and Sediment Control Measures

A. General

The following sections provide design information for a variety of erosion and sediment control measures. Each section describes the measure, how to properly design and implement it, and the benefits that it provides. Each measure's benefits are shown on the first page and a rating (high, medium, or low) is given for each; a summary of the individual measures and their benefits is shown in Table 7E-1.01. The benefits have been divided into five categories that directly affect erosion or sediment transportation. The following are descriptions of each of the benefits shown in Table 7E-1.01.

B. Flow Control

Flow control refers to the ability of a practice to reduce flow velocity (either sheet or concentrated flow). Reducing flow velocity helps reduce erosion and transportation of sediment. Controlling velocity is important on long or steep slopes. High-velocity flows can quickly cause severe erosion.

C. Erosion Control

Erosion control is the measure's ability to stabilize the surface and prevent soil particles from becoming displaced. Erosion control should be utilized on all disturbed surfaces. Preventing erosion from taking place is the simplest and most cost-effective method of keeping sediment from leaving a site.

D. Sediment Control

Sediment control is the ability of a practice to remove suspended soil particles from runoff after erosion has taken place. Sediment control measures are the last line of protection against releasing sediment laden runoff into water bodies or waterways.

E. Runoff Reduction

Runoff reduction is the ability to reduce the volume of runoff from a site. Reducing the volume from an area also reduces the potential for both erosion and sediment transportation. These methods utilize absorption or increase the potential for infiltration of stormwater into the soil.

F. Flow Diversion

Flow diversion consists of routing upland runoff around disturbed areas. By reducing the amount of runoff over a disturbed area, the potential for erosion and sediment transportation are also reduced.

G. Selecting Control Measures

The following table may be used to select a system of both erosion control and sediment control measures. No single measure should be relied upon as the sole method of erosion control and sediment control.

Table 7E-1.01: Summary of Erosion and Sediment Control Measures and Benefits

Section	Control Measure	Benefits				
		Flow Control (Velocity)	Erosion Control (Stabilization)	Sediment Control (Removal)	Runoff Reduction (Volume)	Flow Diversion
<i>Vegetative and Soil Stabilization Erosion Control Measures</i>						
7E-2	Compost Blanket	M	M	L	M	
7E-5	Temporary Rolled Erosion Control Products	L	H			
7E-16	Dust Control		M			
7E-17	Erosion Control Mulching	L	M	L	L	
7E-18	Turf Reinforcement Mats	L	H			
7E-19	Surface Roughening	L	L		L	
7E-22	Temporary Erosion Control Seeding	M	H	M	L	
7E-23	Grass Channel	L	H	L	L	
7E-24	Permanent Seeding	M	H	M	M	
7E-25	Sodding	M	H	M	M	
7E-26	Vegetative Filter Strip	L	L	M	L	
<i>Structural Erosion Control Measures</i>						
7E-7	Check Dams	H		L		
7E-8	Temporary Earth Diversion Structures					H
7E-9	Level Spreaders	H				M
7E-10	Rip Rap	H	H			
7E-11	Temporary Pipe Slope Drains					H
7E-21	Flow Transition Mats	L	H			
7E-27	Rock Chutes and Flumes	M	H			
<i>Sediment Control Measures</i>						
7E-3	Filter Berms	L		L		L
7E-4	Filter Socks	L		L		L
7E-6	Wattles	L		L		
7E-12	Sediment Basin	H		H	L	
7E-13	Sediment Traps	H		H	L	
7E-14	Silt Fences	L		M		M
7E-15	Stabilized Construction Entrance			L		
7E-20	Inlet Protection			L		
7E-28	Flocculents			H		
7E-29	Flotation Silt Curtain			M		

Compost Blanket



<u>BENEFITS</u>			
	L	M	H
Flow Control	██████	██	
Erosion Control	██████	██	
Sediment Control	██	██	██
Runoff Reduction	██████	██	
Flow Diversion	██	██	██

Description: A 1 to 4 inch surface application of compost/mulch or a blend of both to protect areas with erosive potential.

Typical Uses: Used to protect bare soil surfaces from raindrop impact, prevent/reduce sediment loss, reduce surface water runoff, and promote seed growth for establishment of ground cover.

Advantages:

- Immediately protects 100% of the ground surface upon application.
- Conforms to any terrain.
- Reduces rill erosion and the volume of stormwater runoff.
- Allows for natural infiltration and percolation of water into underlying soil.
- Can be combined with seed and placed in a one-step process with pneumatic blower truck.
- Can be used when projects have begun too late in the growing season to establish erosion control vegetation.
- Has high water retention properties, thereby reducing watering requirements during dry weather periods.
- Can be used in areas with poor quality soils (low organic matter) that do not support vigorous growth of vegetation.

Limitations:

- Not suitable for areas of concentrated water flow unless used in conjunction with other control measures that slow velocities.
- Erosion control benefit of compost is eliminated if material is incorporated (tilled) into soil.
- Susceptible to wind erosion.

Longevity: One year; longer if seeding combined

SUDAS Specifications: Refer to [Section 9040.2.01](#) and [3.05](#)

A. Description/Uses

A compost blanket consists of a layer of compost/mulch or a blend of both placed on denuded areas to help prevent initiation of runoff and erosion. Apply compost blanket to a depth of 2 to 4 inches, depending on slope steepness. When a pneumatic blower truck is utilized, a compost blanket can be installed and seeded simultaneously for permanent vegetation establishment.

A compost blanket is both an erosion control and stormwater quality practice. Compost blankets stabilize the soil, prevent splash, sheet, and rill erosion, and remove suspended soil particles and contaminants from water moving offsite and into adjacent waterways or stormwater conveyance systems.

B. Design Considerations

Compost quality and screen size is important. Coarse compost tends to provide more protection than fine material. The coarser compost includes particles which are large enough to prevent them from being washed away or displaced by the rainfall. Fine compost particles can be dislodged and washed away, eliminating any potential protection.

For full erosion control benefits, compost should not be incorporated (tilled) into underlying soil.

In order to prevent water from sheeting between the compost blanket material and soil surface on a slope, a minimum 3-foot wide band of blanket material should be placed behind the top of the slope. Alternatively, a compost berm or filter sock may be placed at the top of the slope.

Compost can be seeded for temporary and/or permanent vegetation during or immediately after installation. For vegetated compost blankets (pneumatic seeding), a maximum blanket depth of 2 inches is recommended. Deeper compost depths can prevent the roots of the vegetation from growing down into the underlying soil. This process is important in developing long term slope stability.

With turf or sod, compost can replace topsoil requirements; 1 inch of compost is equivalent to 3 inches of topsoil.

C. Application

Application rates should be between 2 to 3 inches in depth (270 to 405 cubic yards per acre) with greater depths for steeper slopes.

Table 7E-2.01: Compost Blanket Thickness on Slopes

Slope	Compost Thickness (inches)
2:1 (see comments below)	4
3:1	3
4:1	2

Compost blankets may be used to stabilize steep slopes (up to 2:1) if additional measures are provided. For these severe applications, the slope length should be reduced through the installation of silt fence, filter berms or filter socks. A maximum spacing of 25 feet between slope reduction practices should be provided. In addition, lightweight mulch control netting should be placed under the compost and anchored into place. These additional practices help stabilize the blanket and prevent the material from sliding down steep grades.

D. Maintenance

The disturbed ground under the blanket should be checked in spots for failure. Common failures, due to concentration of water flows or the improper type of compost used, will result in splash, sheet or rill erosion of the underlying soil. Damage should be repaired immediately to prevent further erosion.

E. Time of Year

Compost blankets are effective on a year-round basis. Unlike other erosion control measures, installation is possible when the ground is wet or frozen, especially if a pneumatic blower truck is utilized for placement.

F. Regional Location

The availability of compost blankets are affected by regional location, due to adequate supplies of compost and composting facilities.

Filter Berms



BENEFITS

	L	M	H
Flow Control	■	□	□
Erosion Control	□	□	□
Sediment Control	■	□	□
Runoff Reduction	□	□	□
Flow Diversion	■	□	□

Description: A filter berm is a windrow-shaped (triangular) structure with a specified ‘filter material’ that normally is a blend of composted materials or other organic products, used to slow flow velocity, capture and degrade chemical pollutants, and trap sediment.

Typical Uses: Perimeter control, slope length reduction, flow diversion for small drainage areas, environmentally sensitive areas such as wetlands and waterways, at the edge of gravel parking lots, and general areas under construction.

Advantages:

- Less likely to obstruct wildlife movement and migration than other practices.
- Does not always need to be removed, thereby eliminating removal and disposal costs.
- Can be installed year-round in difficult soil conditions such as frozen or wet ground, on hard compacted soils, near pavements, and in wooded areas.

Limitations:

- Not suitable for areas of concentrated water flow or below culvert outlet aprons.
- Availability of suitable filter materials may be limited.
- Equipment operators may drive over berms, damaging the product.

Longevity: Six months

SUDAS Specifications: Refer to [Section 9040, 2.03](#) and [3.06](#)

A. Description/Uses

A filter berm typically consists of a three-dimensional matrix of biologically active stable composted organic material with various sized particles formed in a continuous windrow fashion (triangular) that slows and filters water to capture sediment and degrade pollutants. Its natural permeability allows water to seep through it while capturing sediment in its pore space and behind its mass, slowing water velocity and absorbing water pollutants, such as hydrocarbons, nutrients, and bacteria.

B. Design Considerations

- 1. Materials:** The key to achieving the proper balance between sediment removal and flow-through rate is using a filter material with the proper particle size. Filter material with a high percentage of fine particles will clog and create a barrier to flow. This will cause water to pond and the pressure may cause the installation to fail. Alternatively, filter material with particles that are too large will allow runoff to pass through the barrier with little or no resistance, eliminating the velocity reduction and sediment trapping benefits of the barrier. Refer to [SUDAS Specifications Section 9040](#) for proper filter material size.
- 2. General Guidelines:** Filter berms should maintain a 2:1 base to height ratio to ensure berm stability, with a minimum berm size of 1 foot high by 2 feet wide.
- 3. Slope Control:** When installed on slopes, filter berms should be installed along the contour of the slope, perpendicular to sheet flow. The beginning and end of the installation should point slightly up the slope, creating a “J” shape at each end to contain runoff and prevent it from flowing around the ends of the berm. Allowable slope length for compost filter berms is dependent upon the grade of the slope as shown in Table 7E-3.01. For slopes that receive runoff from above, a filter berm should be placed at the top of the slope to control the velocity of the flow running onto the slope, and to spread the runoff out into sheet flow. On steep or excessively long slopes a number of filter berms may be placed at regular intervals down the slope.
- 4. Sediment Control:** Filter berms remove sediment both by filtering, and by ponding water behind them. When used for sediment control, filter berms should be located to maximize the storage volume created behind the berm.

A common location to place filter berms for sediment control is at the toe of a slope. When used for this application, the berm should be located as far away from the toe of the slope as practical to ensure that a large storage volume is available for runoff and sediment.

C. Application

Compost filter berms should be spaced according to Table 7E-3.01.

Table 7E-3.01: Maximum Filter Berm Spacing

Slope	Maximum Spacing (feet)	Compost Berm Size Height x Width (feet)
0% to 2%	125	1 x 2
2% to 5%	75	1 x 2
5% to 10%	50	1 x 2

As mentioned previously, the material properties of the filter material are a significant factor in the performance of the berm. The wood chip product typically used as a filter material may not be readily available in all areas. This may limit the utilization of filter berms as an economical sediment control option in some areas.

D. Maintenance

Accumulated sediment should be removed, or a new berm installed, when it reaches approximately one-half of the berm height. If concentrated flows are bypassing or breaching the berm, it must be expanded, enlarged, or augmented with additional erosion and sediment control practices. Additional filter material should be added as required to maintain the dimensions of the berm. Any damage should be repaired immediately.

Filter Socks



Source: Soil-Tek

BENEFITS

	L	M	H
Flow Control	■	□	□
Erosion Control	□	□	□
Sediment Control	■	□	□
Runoff Reduction	□	□	□
Flow Diversion	■	□	□

Description: A filter sock is a tubular mesh sock filled with a specified ‘filter material’ that normally is a blend of composted materials or similar organic products, used to slow flow velocity, capture and degrade chemical pollutants, and trap sediment. They are most effective when designed to provide comprehensive water and sediment control throughout a construction site and if used in conjunction with other erosion control practices.

Typical Uses: Perimeter control, inlet protection, slope length reduction, flow diversion for small drainage areas, environmentally sensitive areas such as wetlands and waterways, at the edge of gravel parking lots, and general areas under construction.

Advantages:

- Less likely to obstruct wildlife movement and migration than other practices.
- Does not always need to be removed, thereby eliminating removal and disposal costs.
- Can be installed year-round in difficult soil conditions such as frozen or wet ground, on hard compacted soils, near pavements, and in wooded areas, as long as stakes can be driven.
- Relatively low cost.

Limitations:

- Not suitable for areas of concentrated water flow, low points of concentrated runoff or below culvert outlet aprons.
- Availability of suitable sock filtering materials and equipment may be limited.
- Equipment operators may drive over socks, damaging the product.
- Often used improperly as the sole method of sediment control.
- Uneven ground may cause leakage under socks.

Longevity: Until sediment accumulates to one-half the height of the sock

SUDAS Specifications: Refer to [Section 9040, 2.04](#) and [3.07](#)

A. Description/Uses

A filter sock typically consists of a three-dimensional matrix of certified, composted organic material and/or other organic matter to create a filter medium. These various sized particles enclosed in a tubular mesh material slows and filters water to capture sediment and degrade pollutants. Its natural permeability allows water to seep through it while capturing sediment in its pore space and behind its mass, slowing water velocity, and absorbing water pollutants, such as hydrocarbons, nutrients, and bacteria.

The filter socks are typically constructed by filling a mesh tube with organic filter material, although other materials, such as crushed rock or gravel may be used. The sock may be filled by blowing the material into the tube with a pneumatic blower or similar device such as an auger system. Hand filling is not an acceptable means to fill the tube as the material is not compacted in the sock.

B. Design Considerations

- 1. Materials:** Several types of materials can be utilized for filter material in the sock. The key to achieving the proper balance between sediment removal and flow-through rate is using a material with the proper particle size. Filter material with a high percentage of fine particles will clog and create a barrier to flow. This will cause water to pond and the pressure could cause the installation to fail. Alternatively, filter materials with particles that are too large will allow flows to pass through the barrier with little or no resistance, eliminating the velocity reduction and sediment trapping benefits of the barrier. Refer to [SUDAS Specifications Section 9040](#) for proper filter material size.

Filter material normally consists of wood chips or mulch that is screened to remove some of the fines and produce the desired gradation. Crushed stone or gravel is an ideal material to use when the sock will be used on a paved street for inlet protection, or other areas where the sock cannot be staked to hold it in place. The additional weight of the stone helps prevent the sock from moving. Socks can be filled with a fine compost material for applications where the sock is to be vegetated and remain as a permanent feature. This material should only be used in areas where ponding water is acceptable since it has a low flow-through rate, and will quickly plug with sediment.

The mesh sock used to contain the compost is designed to photo-degrade over time (approximately 18 months).

- 2. General Guidelines:** When installed on slopes, filter socks should be installed along the contour of the slope, perpendicular to flow, and staked at 10 foot intervals. The beginning and end of the installation should point slightly up the slope, creating a “J” shape at each end to contain runoff and prevent it from flowing around the ends of the sock. Individual section of filter sock should be limited to 200 foot lengths. This limits the impact if a failure occurs, and prevents large volumes of water from accumulating and flowing to one end of the installation, which may cause undermining or damage to the sock.

3. **Slope Control:** Filter socks can be installed at regular intervals on long slopes to reduce the effective slope length, and limit the velocity of runoff flowing down the slope. The design layout of filter socks will help prevent concentrated flows from developing, which can cause rill and gully erosion. As a secondary benefit, filter socks installed on slopes can remove suspended sediment from runoff that results from any erosion that has occurred. Allowable slope length for filter socks is dependent upon the size of the sock and the grade of the slope as shown in Table 7E-4.01. For slopes that receive runoff from above, a sock should be placed at the top of the slope to control the velocity of the flow running onto the slope, and to spread the runoff out into sheet flow. On steep or excessively long slopes a number of socks may be placed at regular intervals down the slope.
4. **Sediment Control:** Filter socks remove sediment both by filtering, and by ponding water behind them. When used for sediment control, filter socks should be located to maximize the storage volume created behind the sock.

A common location to place filter socks for sediment control is at the toe of a slope. When used for this application, the sock should be located as far away from the toe of the slope as practical to ensure that a large storage volume is available for runoff and sediment.

5. **Inlet Protection:** Filter socks may also be used to provide inlet protection. The drainage area to a filter sock around an intake should not exceed 1/4 acre for every 100 feet of sock unless used in conjunction with other erosion and sediment control practices. Filter socks used for inlet protection should be staked at regular intervals, not exceeding 6 to 8 feet, to prevent movement of the sock. For protection of curb inlets in pavement, the length of sock recommended above is not practical. Using short sections of filter socks, such as those for curb intakes in pavement, should be done with caution. Because the length of filter sock is short, it is only able to filter a small volume of runoff. This increases the chances that significant ponding will occur, possibly dislodging the sock, or that the flows will simply bypass or overtop the sock, eliminating any treatment potential. For additional information on inlet protection, refer to [Section 7E-20](#).

Figure 7E-4.01: Typical Filter Sock Installation
(From [SUDAS Specifications Figure 9040.102](#))

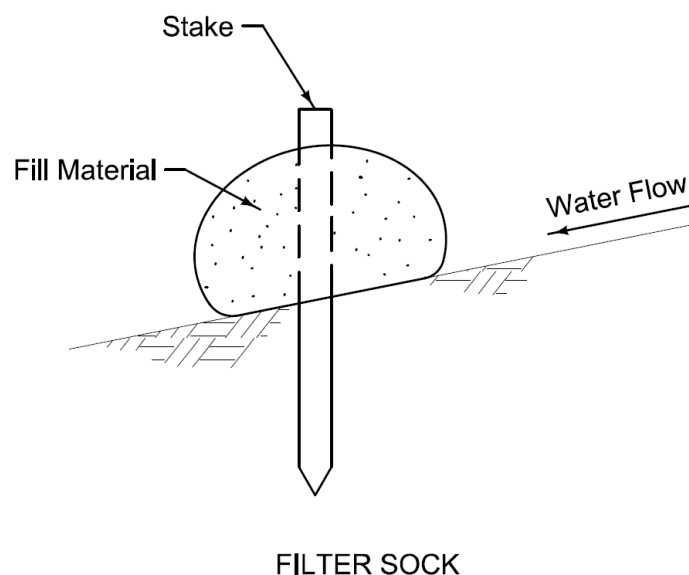

C. Application

Filter socks, placed on slopes, should be spaced according to Table 7E-4.01.

Table 7E-4.01: Maximum Filter Sock Spacing

Slope	Sock Diameter			
	8"	12"	18"	24"
2%	85'	100'	100'	100'
5%	50'	75'	100'	100'
10%	40'	50'	85'	100'
5:1	35'	40'	55'	60'
4:1	30'	40'	50'	50'
3:1	30'	35'	40'	40'

As mentioned previously, the material properties of the filter are a significant factor in the performance of the sock. The wood chip product typically used as a filter material may not be readily available in all areas. This may limit the utilization of filter socks as an economical sediment control option in some areas.

D. Maintenance

Accumulated sediment should be removed, or a new sock installed, when it reaches approximately one-half of the sock diameter. If sheet flows are bypassing or breaching the sock during design storm events, it must be repaired immediately and better secured, expanded, enlarged, or augmented with additional erosion and sediment control practices.

Temporary Rolled Erosion Control Products (RECP)



Source: North American Green - SC150

<u>BENEFITS</u>			
	L	M	H
Flow Control	<input checked="" type="checkbox"/>	<input type="checkbox"/>	<input type="checkbox"/>
Erosion Control	<input checked="" type="checkbox"/>	<input checked="" type="checkbox"/>	<input checked="" type="checkbox"/>
Sediment Control	<input type="checkbox"/>	<input type="checkbox"/>	<input type="checkbox"/>
Runoff Reduction	<input type="checkbox"/>	<input type="checkbox"/>	<input type="checkbox"/>
Flow Diversion	<input type="checkbox"/>	<input type="checkbox"/>	<input type="checkbox"/>

Description: Temporary RECPs consist of prefabricated blankets or netting which are formed from both natural and synthetic materials.

Typical Uses: Temporary RECPs are used as a temporary surface stabilizing measure and to aid in the establishment of vegetation. RECPs are typically used on steep slopes and in vegetated channels.

Advantages:

- Numerous manufacturers, each with a number of different products, allow for the selection of a product that meets the individual characteristics of each site.
- Stabilizes disturbed slope and protects surface from erosive forces of raindrop impact.
- Promotes growth of vegetation.
- Most products degrade over time, eliminating potential maintenance issue.

Limitations:

- With numerous products available, appropriate product selection can be difficult.
- Various products and manufacturers have different design and construction standards. Designer must rely on manufacturer's data.
- RECPs are temporary and do not provide permanent stabilization.
- Permanent stabilization and protection is dependent on the establishment of vegetation.

Longevity: Varies based upon product specified (3 months to 36 months)

SUDAS Specifications: Refer to [Section 9040.2.05](#) and [3.08](#)

A. Description/Uses

Temporary rolled erosion control products (RECP) consist of netting or blanket materials that are used to stabilize disturbed surfaces and promote the establishment of vegetation. RECPs may also be used to stabilize the surface of channels until vegetation can be established, for low to moderate flow conditions.

They are manufactured from a wide variety of different materials including coconut fiber (coir), jute, nylon, polypropylene, PVC, straw, hay, or wood excelsior. These materials may be used individually, or in combination to form nets or blankets.

The products function by protecting the ground surface from the impact of raindrops and stabilize the surface until vegetation can be established. RECPs also promote the growth of vegetation by helping to keep seed in place, and by maintaining a consistent temperature and moisture content in the soil.

RECPs are not intended to provide long-term or permanent stabilization of slopes or channels. Their role is to protect the surface until the vegetation can establish itself and become the permanent stabilizing feature. In fact, most RECPs are either biodegradable or photodegradable and will decompose over a period of time.

B. Design Considerations

RECPs are produced by a number of manufacturers, and are available in a wide variety of different configurations. Competing products from different manufacturers can have completely different material compositions and construction, but be intended to serve the same purpose. Given the wide variety of RECPs available, product selection and specification can be difficult. Fortunately, the Erosion Control Technology Council (ECTC) has developed a uniform product selection guide for RECPs. The ECTC is an organization representing suppliers and manufacturers of rolled erosion control products. A list of member organizations is available on their website (www.ectc.org).

Table 7E-5.01 follows the guidelines of the ECTC and classifies products based upon longevity and product description. RECP longevity is divided into 4 categories ranging from 3 months to 3 years. RECPs are further classified by their general material properties and construction. These classifications include: mulch control nets, open weave textiles, and erosion control blankets.

Mulch control nets (MCN) are used in conjunction with loose mulches. The MCN is applied over the loose mulch to stabilize and hold it in place. MCNs are used as an intermediate application where loose mulch may not be stable, but an open weave textile or erosion control blanket is not necessary.

Open weave textiles (OWT) consist of natural or synthetic yarns that are woven into a 2-D matrix. OWT are similar to mulch control nets, but have higher strength and a more tightly woven construction, allowing them to provide erosion protection with or without the use of an underlying loose mulch layer.

While available, the use of mulch control nets and open weave textiles as rolled erosion control products is fairly uncommon. Erosion control blankets (ECB) are the most commonly used RECP. ECB are constructed of natural and synthetic materials that are glued, woven, or structurally bound with a netting or mesh. The most common of these products are made from straw, wood excelsior or coconut fiber attached to/between netting. Wide varieties of erosion control blankets are available.

ECTC also established recommendations on the appropriate use/performance for each product classification. RECP selection and design should follow the product classification and recommendation shown in Table 7E-5.01.

For slope applications, the designer should select a product from Table 7E-5.01 that has the desired longevity and is rated for the proposed slopes.

For channel applications, the channel lining should be analyzed for the 10 year storm in the permanent vegetated state (ignoring the RECP) as described in [Section 7E-23](#) (Grass Channel). The RECP should also be analyzed for shear stress. This analysis should be for the unvegetated state, representing the situation immediately after installation. Since it is considered a temporary measure, stabilizing the channel only until vegetation is established, the RECP does not need to be analyzed for a 10 year event as the vegetation does. Analyses of the RECP's shear strength for a 2 year event is adequate.

Proper installation of RECPs is critical. Prior to placing a RECP, the ground should be prepared and the area should be seeded and fertilized. It is imperative that seeding occur prior to placement of the RECP to ensure proper contact between seed and soil. Some manufacturers can embed the specified seed mixture into the product during the manufacturing process (if this process is used, follow the manufacturer's recommended installation specifications). After seeding, the appropriate RECP may be placed and anchored with stakes or staples. The manufacturer will provide specifications for the pattern and spacing of anchor stakes or staples, overlap between rolls (typically 6 inches), and any additional product requirements. It is important that the stakes or staples be properly installed to prevent "tenting" of the product as the vegetation begins to grow and push up on the matting. This can create an unsightly situation and the product can become entangled in mowing equipment.

At the tops of slopes and at the entrance to a channel, the leading edge of the RECP should be trenched into the ground, approximately 6 inches, anchored in place with stakes or staples, and backfilled. This prevents runoff from lifting the leading edge, and flowing between the ground and the RECP. Subsequent segments of RECPs should have their upstream edges trenched in, and the downstream edge should slightly overlap the next section to prevent water from flowing under the product.

Table 7E-5.01: Typical Rolled Erosion Control Product Properties and Uses

Type	Product Description	Material Composition	Slope Applications	Channel Applications
			Max. Grade	Permissible Shear Stress ^{1,2}
ULTRA SHORT-TERM - Typical 3 Month Functional Longevity				
1.A	Mulch Control Nets	A photodegradable synthetic mesh or woven biodegradable natural fiber netting	5:1 (H:V)	0.25 lbs/ft ²
1.B	Netless Rolled Erosion Control Blankets	Natural and/or polymer fibers mechanically interlocked and/or chemically adhered together to form a RECP	4:1 (H:V)	0.5 lbs/ft ²
1.C	Single-net Erosion Control Blankets and Open Weave Textiles	Processed degradable natural and/or polymer fibers mechanically bound together by a single rapidly degrading, synthetic or natural fiber netting or an open weave textile of processed rapidly degrading natural or polymer yarns or twines woven into a continuous matrix.	3:1 (H:V)	1.5 lbs/ft ²
1.D	Double-net Erosion Control Blankets	Processed degradable natural and/or polymer fibers mechanically bound together between two rapidly degrading, synthetic or natural fiber nettings.	2:1 (H:V)	1.75 lbs/ft ²
SHORT-TERM - Typical 12 Month Functional Longevity				
2.A	Mulch Control Nets	A photodegradable synthetic mesh or woven biodegradable natural fiber netting	5:1 (H:V)	0.25 lbs/ft ²
2.B	Netless Rolled Erosion Control Blankets	Natural and/or polymer fibers mechanically interlocked and/or chemically adhered together to form a RECP	4:1 (H:V)	0.5 lbs/ft ²
2.C	Single-net Erosion Control Blankets and Open Weave Textiles	An erosion control blanket composed of processed degradable natural or polymer fibers mechanically bound together by a single degradable synthetic or natural fiber netting to form a continuous matrix or an open weave textile composed of processed degradable natural or polymer yarns or twines woven into a continuous matrix.	3:1 (H:V)	1.5 lbs/ft ²
2.D	Double-net Erosion Control Blankets	Processed degradable natural and/or polymer fibers mechanically bound together between two degradable synthetic or natural fiber nettings.	2:1 (H:V)	1.75 lbs/ft ²
EXTENDED-TERM - Typical 24 Month Functional Longevity				
3.A	Mulch Control Nets	A slow degrading synthetic mesh or woven natural fiber netting	5:1 (H:V)	0.25 lbs/ft ²
3.B	Erosion Control Blankets and Open Weave Textiles	An erosion control blanket composed of processed slow degrading natural or polymer fibers mechanically bound together between two slow degrading synthetic or natural fiber nettings to form a continuous matrix or an open weave textile composed of processed slow degrading natural or polymer yarns or twines woven into a continuous matrix.	1.5:1 (H:V)	2.0 lbs/ft ²
LONG-TERM - Typical 36 Month Functional Longevity				
4	Erosion Control Blankets and Open Weave Textiles	An erosion control blanket composed of processed slow degrading natural or polymer fibers mechanically bound together between two slow degrading synthetic or natural fiber nettings to form a continuous matrix or an open weave textile composed of processed slow degrading natural or polymer yarns or twines woven into a continuous matrix.	1:1 (H:V)	2.25 lbs/ft ²

¹ Refer to [Section 7E-18 - Turf Reinforcement Mats](#) for additional information on determining shear stress in a channel

² Minimum shear stress RECP (unvegetated) can sustain without physical damage or excess erosion (0.5 inch soil loss during 30 minute flow event)

Source: Lancaster and Austin, 2004

C. Application

Rolled erosion control products should be used on bare ground that is highly susceptible to erosion, such as slope and channels, and in locations where establishing vegetation may otherwise be difficult.

There are a wide variety of RECPs available. Table 7E-5.01 shows the recommended applications for slopes and channels for each type of product. A manufacturer or supplier can provide further assistance in selecting an appropriate RECP. For channel applications, products that contain straw are not recommended due to the likelihood that the concentrated flow will dislodge the straw from the binding material, creating the potential for clogging problems downstream.

D. Maintenance

Once installed, there is little maintenance that needs to be done to RECPs. If the RECPs are vegetated, the vegetation should be watered as needed (refer to [Section 7E-24](#)). Until the vegetation is fully established, the surface should be inspected for signs of rill or gully erosion below the matting. Any signs of erosion, tearing of the product, or areas where the product is no longer anchored firmly to the ground should be repaired.

E. Time of Year

Seeding and placement of RECPs should be completed well within the annual seeding window. While RECPs provide some stabilization of the channel or slope surface until the vegetation is established, the vegetation ultimately provides stabilization of the surface. The vegetation needs time to establish so it can resist flows from winter snowmelt and spring rains.

F. Design Example

Due to difficulty establishing vegetation, and concerns with channel erosion, assume that a RECP is proposed for the design example from [Section 7E-23](#) (Grass Channel).

Find the shear stress in the bare channel after the RECP has been installed. Determine if the RECP is sufficient to temporarily stabilize the channel, until the vegetation can become established.

The manufacturer states that the RECP can withstand a shear stress (without vegetation) of 2.0 lbs/ft². In addition, the manufacturer states that for depths between 0.5 feet and 2 feet, the Manning coefficient for the RECP varies from 0.05 to 0.018 respectively. The coefficient used for the analysis should be interpolated based upon the depth.

Assume a flow depth of 1.5 feet. Interpolating, the Manning coefficient is 0.029.

Trial 1 - Assume a depth of 1.5 feet. Interpolating, the Manning coefficient is 0.029.

Area, $A=13.5$; Wetted Perimeter, $P=15.4$; Hydraulic Radius, $R=0.88$
From Manning's Equation, $Q=50$ cfs. This is too high. Try a lower depth.

Trial 2 - Try 1.0 feet. $n= 0.039$.

$A=8.4$; $P=12.1$; $R=0.67$; $Q=19.5$ cfs Too low. Try higher depth.

Trial 3 - Try 1.1 feet. $n=.0372$

$A=8.1$; $P=12.1$; $R=0.67$; $Q=25.07$ cfs. Say 24 cfs. OK

Find the shear stress on the bare RECP liner.

$$\tau_{\max} = \gamma \times d \times S = 62.4 \times 1.1 \times 0.01 = 0.69 \text{ lbs/ft}^2$$

0.69 lbs/ft^2 is less than the allowable value of 2.0 lbs/ft^2 . The RECP liner should adequately protect the channel until vegetation is established.

Wattles



Source: Clackamas County, 2000

<u>BENEFITS</u>			
	L	M	H
Flow Control	■	□	□
Erosion Control	□	□	□
Sediment Control	■	□	□
Runoff Reduction	□	□	□
Flow Diversion	■	□	□

Description: Wattles are a sediment and stormwater velocity control device. They are tubes of straw, rice straw, or coconut husk encased in ultraviolet (UV) degradable plastic netting or 100% biodegradable burlap material. Wattles help stabilize slopes by breaking up the length, and by slowing and spreading overland water flow.

Typical Uses: Wattles may be suitable along the toe, top, face, and at grade breaks of exposed and erodible slopes to shorten slope length and spread runoff as sheet flow; at the end of a downward slope where it transitions to a steeper slope; along sidewalks and curbs to prevent sediment from washing into gutters; around storm drains and drop inlets; down-slope of exposed soil areas; and around temporary material spoil and stockpiles, such as topsoil and for streambank (sensitive area) protection.

Advantages:

- Lightweight, easy to stake, and may be installed quickly.
- Removal is not necessary, as wattles are typically left in place permanently to biodegrade and/or photo-degrade.
- Wattles come in a variety of diameters and lengths.

Limitations:

- They are difficult to move once saturated.
- Wattles are temporary, lasting only one or two seasons.
- If not properly staked and trenched in, wattles can be transported by high flows.
- Wattles have a very limited sediment capture zone.
- Wattles should not be used on slopes subject to creep or slumping.

Longevity: Varies, 3 to 6 months or until sediment accumulates to one-half the height of the wattle

SUDAS Specifications: Refer to [Section 9040, 2.06](#) and [3.09](#)

A. Description/Uses

Wattles are formed by filling tubular netting with fibrous organic material such as straw, rice straw, or coconut fiber inside of a mesh sock. Alternatively, a wattle may be constructed by tightly rolling a straw/coconut erosion control blanket to form a multi-layer roll.

The completed wattle consists of a long, flexible tube that may be installed along the contours of slopes or at the base of slopes to help reduce soil erosion and retain sediment. Wattles can be highly effective when they are used in combination with other surface soil erosion/re-vegetation practices, such as surface roughening, straw mulching, erosion control blankets, and hydraulic mulching. When wattles are placed at the toe and on the face of slopes, they intercept runoff, reduce its flow velocity, release the runoff as sheet flow, and provide removal of sediment from the runoff. By interrupting the length of a slope, wattles can also reduce erosion.

B. Design Considerations

Wattles should be used to intercept and control sheet flow and should not be used for situations with concentrated flows greater than 1/2 cfs.

Installation of wattles begins by constructing a shallow trench, 2 to 4 inches deep, and shaped to accept the wattle, along the contour of the slope. All debris (rocks and clods) that would prevent close contact between the wattle and soil should be removed. The wattle is placed in the trench, and excavated material from the trench is packed tightly along the base of the wattle, on the uphill side. The wattle should be secured with 1 inch by 1 inch wooden stakes. The stakes should be placed at a 4 foot spacing and driven in perpendicular to the slope through the center of the wattle leaving less than 2 inches of stake exposed above the wattle. The terminating ends of each wattle installation should be turned uphill a minimum of 6 inches to prevent runoff from flowing around the ends of the wattle.

When practical, the wattles may be left in place. Over time, they will break down, decay, and eventually disappear completely. When wattles are removed, any trenches, depressions, or other ground disturbances caused by the removal of the wattle should be backfilled and repaired with the excess sediment captured by the wattle, prior to spreading the straw or other final erosion control protection.

1. **Flat Ground Application:** Install along sidewalks and behind curbs, fitting tightly against the concrete before backfilling, then backfill the wattle to create a trench.
2. **Storm Drain Inlet Protection:** Wattles placed along the back of curb should be offset, as required to go around structures such as curb intakes that project behind the back of curb. At these locations, the wattle should be placed behind the structure (not over it) and shaped to direct water around either side of the structure to prevent ponding. At area intake locations, a shallow trench should be constructed 1 to 2 feet away from the edge of the intake. The wattle should be placed in the trench and firmly staked in place.
3. **Slope Application:**
 - a. Wattles should be installed on the contour.
 - b. Wattles should be installed from the bottom of the slope up.

4. **Materials:** Wattles can be made from straw, rice straw, coconut husk, or other approved material. The netting consists of biodegradable burlap or high-density polyethylene and ethyl vinyl acetate containing ultraviolet inhibitors.

Straw should be Certified Weed Free Forage, by a manufacturer whose principle business is wattle manufacturing. Coir (coconut fiber) can be in bristle and mattress form, and should be obtained from freshwater cured coconut husk.

C. Application

Wattles are available in a variety of diameters ranging from 9 inches to 20 inches. The most common sizes are 9 and 12 inch wattles. The allowable spacing for these diameters is given in Table 7E-6.01.

Table 7E-6.01: Recommended Wattle Spacing by Slope

Slope	Spacing Intervals (feet)	
	9" Diameter	12" Diameter
< 4:1	20	40
2:1 to 4:1	15	30
2:1 or greater	10	20

For soft, loamy soils, the spacing interval should be decreased. For hard, rocky soils, the spacing interval shown in Table 7E-6.01 may be increased.

For highly erosive soils, and for slopes 2:1 or greater, an additional row of wooden stakes should be provided on the downhill side of the wattle.

D. Maintenance

Repair or replace split, torn, unraveling, or slumping wattles.

If the wattle is used as a sediment capture device, or as an erosion control device to maintain sheet flows, sediment that accumulates in the wattle must be periodically removed when accumulation reaches one-half the designated sediment storage depth, usually one-half the distance between the top of the fiber roll and the adjacent ground in order to maintain effectiveness.

If wattles are used for reduction of slope length, sediment removal should not be required as long as the system continues to control the grade. Additional sediment control practices are required to be used in conjunction with this type of application.

Check Dams



<u>BENEFITS</u>			
	L	M	H
Flow Control	██████████		
Erosion Control	□	□	□
Sediment Control	██	□	□
Runoff Reduction	□	□	□
Flow Diversion	□	□	□

Description: Check dams, sometimes called ditch checks, consist of a vertical barrier constructed across swales, ditches, and waterways. These structures are most commonly constructed of erosion stone, although silt fence and manufactured devices are also used. Straw bales were used at one time, however, due to their high rate of failure and low level of effectiveness, their use is severely limited.

Typical Uses: Check dams are used to control the velocity of concentrated runoff in ditches and swales, and to prevent gully erosion until the channel can be stabilized. The structures may also provide some sediment removal benefits, however this is not their primary function.

Advantages:

- Highly effective at reducing flow velocities in channels.
- Simple to construct.
- Low maintenance.

Limitations:

- Steep slopes require short spacing between check dams.
- Sediment removal practices are still required.
- Straw bales are ineffective and prone to failure.
- Removal difficulties if not permanent

Longevity: Rock check dams - 1 year; may be considered permanent. Manufactured devices and silt fence - 6 months.

SUDAS Specifications: Refer to [Section 9040.2.07](#) and [3.10](#)

A. Description/Uses

A check dam is a small, temporary obstruction in a ditch or waterway used to prevent erosion by reducing the velocity of flow. A dam placed in the ditch or channel interrupts the flow of water, thereby reducing the velocity. Although some sedimentation may result behind the dam, check dams do not function as sediment trapping devices and should not be designed as such.

Check dams are most commonly constructed of loosely placed erosion stone or rip rap, or from stone-filled gabions.

Silt fence, placed across a ditch or swale, is often used incorrectly under moderate or high flows as a check dam. Silt fence may be used as a check dam; however, it should be limited to applications where the flow rate will be less than 1 cfs. See [Section 7E-14](#) for additional information on using silt fence as a ditch check.

A variety of manufactured devices are also available for installation as ditch checks. One type of manufactured ditch check consists of a 9 to 10 inch tall, triangular-shaped structure constructed from sheets of perforated HDPE (High Density Polyethylene Pipe). Another manufactured product is constructed from a length of triangular-shaped urethane foam. The foam is wrapped in a geotextile fabric for protection.

Gravel bag berms, formed from a pile of gravel-filled bags, may also be used to construct check dams. The bags may be constructed from a variety of porous fabrics, and are filled with clean, poorly-graded gravel. The purpose of the bag is to prevent individual gravel particles from being dislodged, and to allow the gravel barrier to be easily removed or relocated upon completion of the project.

Straw bales were commonly used in the past. However, field experience has shown that this technique is highly ineffective and prone to failures.

B. Design Considerations

Regardless of the type of check dam installed, the concept for controlling the flow is the same. The check dam interferes with the flow in the channel, dissipating the energy of the flowing water, thereby reducing velocity and channel erosion.

Check dams are not intended to control flows from large drainage areas. Typically, the maximum drainage area to a check dam should be limited to approximately 2 acres.

Check dams should be designed to pass the two-year storm without overtopping the roadway or side slopes of the channel. A weir equation can be used to determine the depth of flow over the structure if necessary.

- 1. Rock Check Dams:** Rock check dams should be placed on top of a blanket of engineering fabric to prevent erosion of the underlying surface as water filters through the dam. A typical stone check dam is 2 feet high, with a 4 foot base and 2:1 side slopes. The crest of the check dam should be 6 inches lower than the sides to prevent flows from going around the dam, and eroding the sides of the channel. These dimensions are approximate, and may be modified based upon individual needs and for larger flows. However, heights much greater than 2 feet increase the potential for scour on the downstream side of the dam. For larger check dams, additional channel protection may be required on the downstream side.

The aggregate used should be large enough to prevent the flows from pushing individual stones downstream. A 6 inch erosion stone is normally sufficient.

Figure 7E-7.01: Typical Rock Check Dam
 (SUDAS Specifications Figure 9040.107)

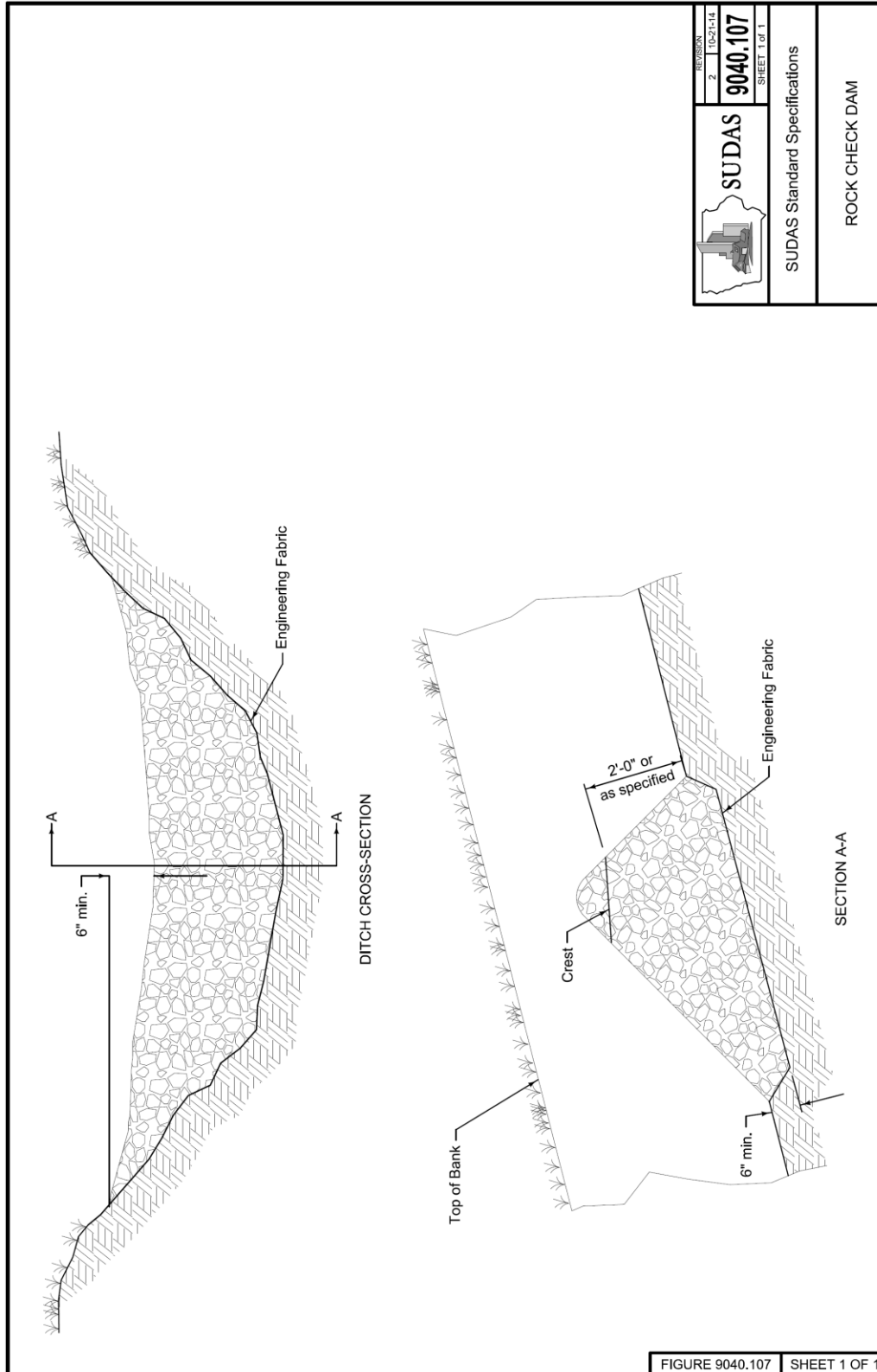

2. **Manufactured Devices:** Triangular-shaped manufactured products should be designed and installed according to their manufacturer's recommendations. These products require anchoring to the ground to keep them in place and may require the installation of a blanket of engineering fabric below them.
3. **Gravel Bag Berms:** Gravel bag berms should be placed and spaced in the same manner as rock check dams. The berms should be placed on a layer of engineering fabric, and be limited to a height of 24 inches. The crest of the check dam should be 6 inches lower than the sides to prevent flows from going around the dam, and eroding the sides of the channel.
4. **Silt Fence:** Silt fence may be used as a ditch check device for very low flow applications. See [Section 7E-14](#) for additional information on this application.

C. Application

Achieving the proper spacing is the most important aspect of check dam design. The spacing between structures is dependent on the height of the check dam, and the grade of the waterway. In order to protect the channel between the check dams, the devices should be spaced such that the elevation of the toe of the upstream check dam is equal to the elevation of the crest of the downstream check dam. This allows the water between the check dams to pond, resulting in a greatly reduced flow velocity.

As a rule, check dams should not be spaced closer than 20 feet in order to allow for proper maintenance. If slopes and check dam height call for a spacing closer than 20 feet, a Rolled Erosion Control Product or Turf Reinforcement Mat should be considered as an alternative.

Figure 7E-7.02: Typical Check Dam Spacing
(From [SUDAS Specifications Figure 9040.106](#))

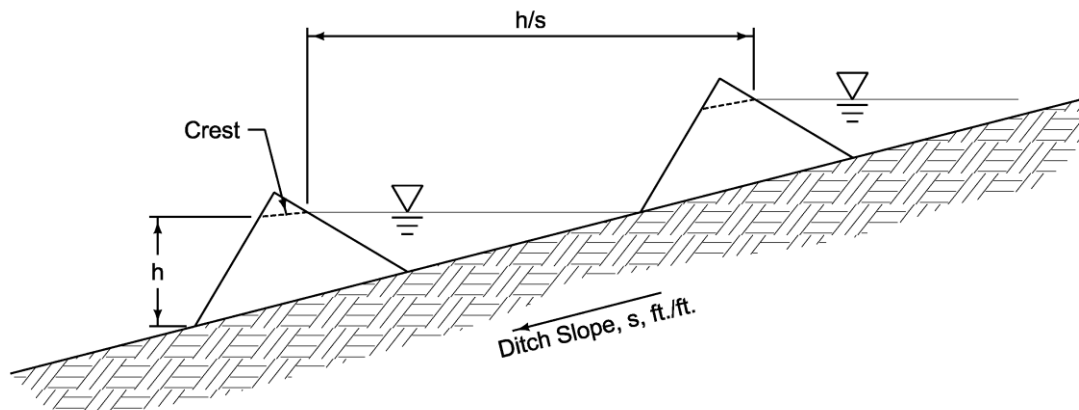

MANUFACTURED CHECK DAM
(Synthetic Permeable and Triangular Foam Check Dam)

D. Maintenance

Check dams should be inspected for damage every seven days and after any 1/2 inch or greater rainfall until final stabilization is achieved. Sediment should be removed when it reaches one-half of the original dam height. Upon final stabilization of the site, the check dams should be removed, including any stone that has been washed downstream, and any bare spots stabilized.

E. Time of Year

Check dams function on a year-round basis.

F. Regional Location

Check dams should be designed to account for the individual characteristics of each site.

Temporary Earth Diversion Structures

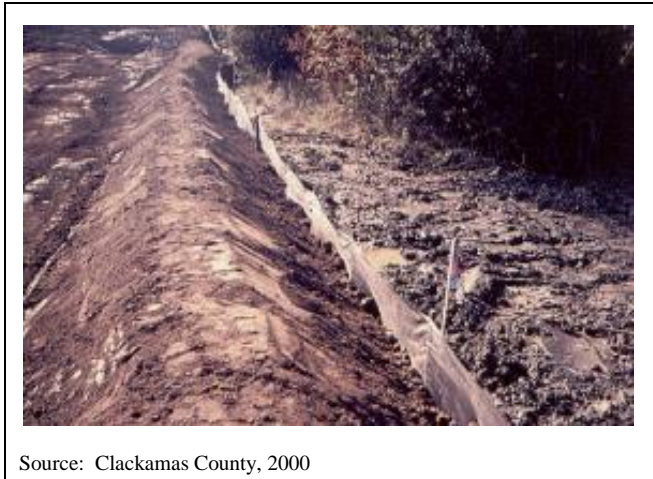

Source: Clackamas County, 2000

<u>BENEFITS</u>			
	L	M	H
Flow Control	<input type="checkbox"/>	<input type="checkbox"/>	<input type="checkbox"/>
Erosion Control	<input type="checkbox"/>	<input type="checkbox"/>	<input type="checkbox"/>
Sediment Control	<input type="checkbox"/>	<input type="checkbox"/>	<input type="checkbox"/>
Runoff Reduction	<input type="checkbox"/>	<input type="checkbox"/>	<input type="checkbox"/>
Flow Diversion			

Description: Consists of an excavated swale, berm, or combination of the two, constructed in such a manner as to direct water to a desired location.

Typical Uses: Diversion structures are used to intercept surface and shallow subsurface flows and divert this water away from disturbed areas, active gullies, and critically eroding areas. Diversion structures can also be constructed along slopes to reduce the slope length, intercepting and carrying runoff to a stable outlet point or letdown structure.

Advantages:

- Reduces the volume of flow across disturbed areas, thereby reducing the potential for erosion.
- Breaks up concentration of water on long slopes.
- Maintaining a separation between clean water and sediment-laden water allows sediment basins and traps to function more efficiently.
- Easily constructed with equipment found on most construction sites.

Limitations:

- High flow velocities can cause erosion in the diversion structure.
- Diversion structures must be stabilized immediately after installation.

Longevity: One year

SUDAS Specifications: Refer to [Section 9040, 3.11](#)

A. Description/Uses

Diversion structures consist of swales or berms that are used to temporarily divert water around an area that is under construction or is being stabilized. Specific applications include perimeter control, diversion away from disturbed slopes, and diversion of sediment-laden water to treatment facilities.

As a perimeter control, temporary swales and/or berms may be constructed above a large disturbed area to divert upstream run-on around the site. This serves several purposes. First, the amount of runoff flowing over the disturbed area is reduced, thereby reducing the erosion potential. Secondly, clean water can be separated from the sediment-laden water and can be passed through or around the site. Sediment-laden water can be directed to a sediment trap or basin for treatment. Separating the upstream runoff from the sediment-laden water allows the designer to reduce the required size of the sediment removal structure, and allows the structure to work more efficiently.

Another specific use of a diversion structure is to keep upstream stormwater off of disturbed slopes or to safely carry it down the slope. This is accomplished by constructing a swale and/or berm at the top of the slope, and conveying it to a letdown structure or stable outlet. On long slopes, they can be placed at regular intervals to trap and divert sheet flow before it concentrates and causes rill and gully erosion.

B. Design Considerations

Diversion structures should be designed to carry peak flows from the 2 year, 24 hour storm. The maximum drainage area conveyed through a diversion structure should be 5 acres.

The depth of the diversion should be based upon the design capacity, plus an additional 4 inches of freeboard. The minimum depth provided should be 18 inches. This may be provided solely by a berm or swale or may be developed with a combination of berm and swale. The shape of the diversion may be parabolic, trapezoidal, or V-shaped, with side slopes of 2:1 or flatter.

The minimum slope of the diversion structure should be sufficient to carry the design flow. The maximum slope of the diversion is limited by the permissible velocities of flows within the structure, as shown in the following table. Since any existing vegetation will likely be destroyed upon construction of the diversion structure, the bare surface situation should be considered for most applications.

Table 7E-8.01: Diversion Structure Slopes by Soil Type

Soil Type	Permissible Velocity (fps)			
	<i>Channel Vegetation</i>			
	<i>Bare</i>	<i>Poor</i>	<i>Fair</i>	<i>Good</i>
Sand, silt, sandy loam, and silty, loam	1.5	1.5	2.0	3.0
Sandy clay, loam, and sandy clay, loam	2.0	2.5	3.0	4.0
Clay	2.5	3.0	4.0	5.0

Source: Smoot, 1999

After construction of the diversion structure, it is important to stabilize the surface immediately with seed and mulch, sod, or other means.

C. Application

Diversion structures should be used around the perimeter of sites to prevent run-on of off-site flows over disturbed ground.

D. Maintenance

The channel should be inspected every seven days and after any 1/2 inch or greater rainfall. Any damage to the vegetated lining should be repaired. All debris should be removed and properly disposed of to provide adequate flow conveyance.

E. Time of Year

When diversion structures are constructed during times when vegetation cannot be established to stabilize the surface, alternative stabilization methods such as sodding or matting may be required.

F. Regional Location

As mentioned above, the allowable velocity within the diversion structure is based upon the soil characteristics of the site. Silty and sandy soils are more prone to erosion than clay soils. However, with the proper design and stabilization methods, diversion structures may be used in all appropriate locations.

Level Spreaders



Source: Umstead Coalition, 2005

<u>BENEFITS</u>	
	L M H
Flow Control	██████████
Erosion Control	□ □ □
Sediment Control	□ □ □
Runoff Reduction	□ □ □
Flow Diversion	██████ □

Description: A level spreader is a low-cost method to convert small volumes of concentrated runoff into sheet flow and release it onto an area stabilized by existing vegetation.

Typical Uses: Level spreaders are commonly used at the outlet of a diversion structure or sediment removal structure to convert concentrated flow to uniform sheet flow prior to releasing the runoff onto stabilized downstream slopes. Level spreaders are also used to convey runoff from impervious surfaces, such as parking lots, onto vegetated areas or into detention basins.

Advantages:

- Widely used BMP due to ease of installation and availability of materials.
- Low cost and simple to construct.

Limitations:

- Flows from a level spreader should be limited to clean, diverted runoff, or runoff that has been passed through a sediment removal structure.
- The downstream slope must have existing vegetation and be capable of accepting sheet flow without incurring erosion.
- May require adjustment after freeze-thaw cycle due to heaving.

Longevity: One year

SUDAS Specifications: Refer to [Section 9040, 2.08](#) and [3.12](#)

A. Description/Uses

A level spreader is a device used at the outlets of dikes and berms to convert the concentrated flows to sheet flow prior to discharging the flow onto a vegetated area downstream of the disturbed site.

A level spreader normally consists of a shallow excavation that serves as a stilling basin to allow runoff to pond up and dissipate its kinetic energy. An overflow weir is constructed to release the accumulated runoff. This weir is normally constructed from a 2 by 8 inch pressure-treated wooden timber placed at 0% grade to ensure uniform flow over the weir. For low flow applications, an earthen weir may also be constructed; however, special attention must be paid to ensure that the weir is level. If low points exist, concentrated flows will result and these could cause damage to the weir and the downstream slope.

B. Design Considerations

The grade of the last 20 feet of the diversion structure channel should be 1% or less to slow the velocity of the flow prior to draining into the depression. This will help reduce turbulence and erosion within the depression.

It is imperative that the receiving area downstream of the weir be stabilized sufficiently to receive the flows from the spreader without causing erosion. The receiving area must also be smooth to preserve the sheet flow and prevent the flow from concentrating. The slope of the receiving area should be less than 10%.

For level spreaders constructed from earthen embankments, a layer of erosion control matting should be placed on either side of the weir to provide additional stability to the surface.

C. Application

The length of the weir and depth of the depression required behind the weir are dependent on the anticipated flows over the weir. Select the length and depth of the spreader from Table 7E-9.01 based upon the 10 year peak flow.

Table 7E-9.01: Level Spreader Properties

Flow (cfs)	Min. Depth (feet)	Min. Length (feet)	Material
0-4	0.5	10	Stabilized Earth
5-10	0.5	10	2" x 8" Timber
10-20	0.6	20	2" x 8" Timber
20-30	0.7	30	2" x 8" Timber
30-40	0.8	40	2" x 8" Timber

D. Maintenance

The downstream slope should be inspected for signs of rilling. If rilling occurs, the length of the spreader may need to be increased, or additional stabilizing practices may need to be employed on the slope. If silt accumulates within the depression, it should be cleaned out when it loses one-third of its volume.

After a freeze-thaw cycle, the level spreader should be inspected to ensure that heaving has not occurred. Any displacement should be corrected to ensure that it is completely level.

E. Time of Year

Level spreaders will function on a year-round basis.

F. Regional Location

For soils that are highly sensitive to erosion, even when fully vegetated, the length of the spreader may need to be increased beyond that shown in the table.

Figure 7E-9.01: Typical Level Spreader Configuration
 (SUDAS Specifications Figure 9040.109)

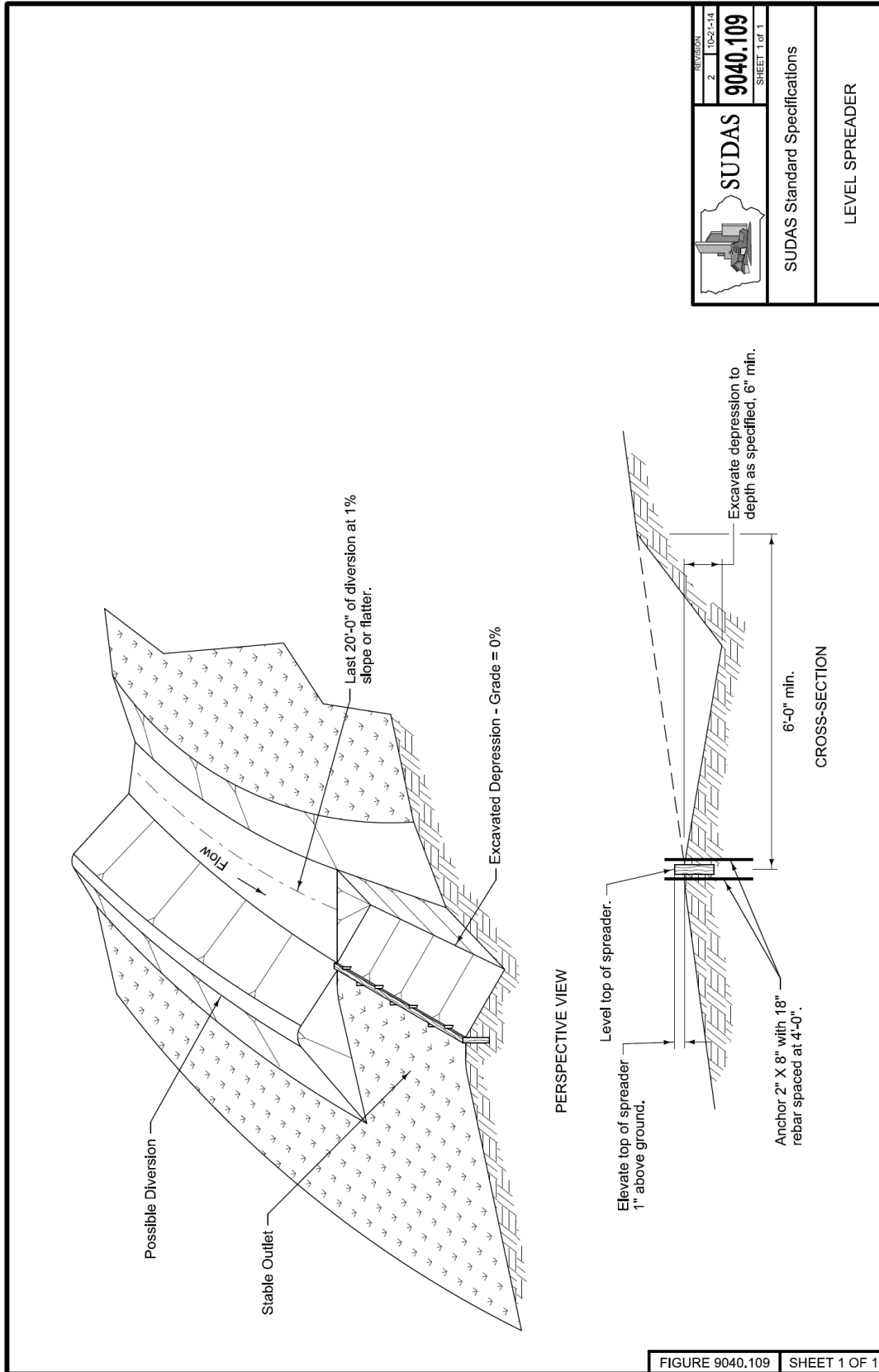

Rip Rap



Source: Mississippi State University

<u>BENEFITS</u>			
	L	M	H
Flow Control	██████████		
Erosion Control	██████████		
Sediment Control	□	□	□
Runoff Reduction	□	□	□
Flow Diversion	□	□	□

Description: Rip rap is a common method of protecting a channel downstream of a storm sewer or culvert outlet from erosion. A layer of crushed stone placed on the bottom and sides of the channel protects the channel and dissipates the energy of the high velocity flow.

Typical Uses: Used at the outlet of storm sewer pipes, roadway and driveway culverts, and at any point concentrated runoff enters a channel.

Advantages:

- Widely used method of erosion protection.
- Materials are readily available in most areas.
- Effective at reducing scour when properly designed and installed.

Limitations:

- Commonly undersized.
- Not aesthetically pleasing.
- May not be adequate for flows from large pipes (>48 inches).
- May be higher cost due to limited availability of stone.

Longevity: Temporary or permanent

SUDAS Specifications: Refer to [Section 9040.2.09](#) and [3.13](#)

A. Description/Uses

The most common method of protecting a channel at an outlet is to place a layer of crushed stone along the bottom and sides of the channel. The purpose of the stone is to protect the channel until the outlet flow loses sufficient velocity and energy, so that erosion will not occur in the downstream channel. Rip rap is provided by constructing a blanket of crushed stone, to a specified depth at the outlet. The layer of the stone is constructed so that the top is flush with the invert elevation of the outlet pipe. The stone should be placed on a layer of engineering fabric to protect the underlying soil from the erosive action of the churning water.

For larger pipes, or for discharges from pipes with large head pressures, greater protection may be required. Additional protection can be provided by constructing a rock-lined plunge pool, stilling basin, or through the use of concrete energy dissipaters (see Chapter 2 - Stormwater).

B. Design Considerations

The following design information only applies to the design of rock protection at outlets. It does not apply to rock lining of channels or streams. In addition, the design of rock plunge pools or stilling basins, and other types of energy dissipaters is not covered in this section. Refer to the Federal Highway Administration Hydraulic Engineering Circular No. 14 (HEC-14), "Hydraulic Design of Energy Dissipaters for Culverts and Channels" for information on designing these structures.

The Iowa DOT Culvert Program (version 2.0) includes three methods of designing rock protection at the outlet of culverts. The methods include HEC-14 rip rap basins, U.S. Army Corps of Engineers scour hole design and U.S. Bureau of Reclamation plunge basin design. This program is available online and can be obtained from the Iowa DOT's Office of Bridges and Structures.

The steps below describe the method of designing rip rap:

- 1. Tailwater Depth:** The first step is to find the tailwater depth at the pipe outlet, corresponding to the appropriate design-year storm event for the outlet structure (see Chapter 2 - Stormwater) for design criteria for various structures). Normally, the tailwater depth is found by determining the normal depth in the channel using Manning's equation (see Chapter 2 - Stormwater). If downstream restrictions such as a culvert, dam or channel constriction exist, a more thorough analysis is required.

If the tailwater is less than half of the discharge flow depth (pipe diameter or box height if flowing full) it is classified as a *minimum tailwater condition*. If the tailwater is greater than or equal to half of the discharge flow depth, it is classified as a *maximum tailwater condition*. The tailwater condition will determine which figure (Figure 7E-10.03 or 7E-10.04) to use to find the necessary rock size and apron dimensions.

Pipes that outlet onto flat areas without a well-defined channel can be assumed to have a minimum tailwater condition.

If the tailwater condition cannot be easily determined for a channel, the apron should be designed for the maximum tailwater condition as a conservative approach.

- 2. Stone Size:** As the discharge flows over the crushed stone, the flow imposes shear stresses on the individual stones. Since the stones are only held in place by the force of gravity, they must have sufficient mass to prevent them from being dislodged by the force of the flowing water. For rip rap design, the crushed stone material is selected based upon its average, or d_{50} , diameter. The d_{50}

diameter represents the size at which half of the individual stones (by weight) are smaller than the specified diameter.

The d_{50} diameter is determined with Figure 7E-10.03 or 7E-10.04, for the appropriate tailwater condition. This value represents the minimum average diameter of stone necessary to resist the anticipated flows.

- a. **Pipes Flowing Full:** The appropriate figure is entered along the x-axis at the design discharge. A vertical line is projected to the curve for the appropriate pipe diameter in the lower set of curves. From this point, a horizontal projection is made to the right, and the minimum d_{50} diameter is read.
- b. **Partially Full Pipes and Box Culverts:** Using the depth of flow and velocity at the outlet, the intersection of d and v in the lower portion of the appropriate figure is found. From this point, a horizontal projection is made to the right, and the minimum d_{50} diameter is read.

Most crushed stone used for outlet protection is specified by weight, not by diameter. The following table lists the standard SUDAS and Iowa DOT revetment and erosion stone weights and corresponding d_{50} diameters. These gradations are also shown on Figures 7E-10.03 and 7E-10.04. Alternative gradations may be selected and specified if available from local aggregate suppliers.

Table 7E-10.01: Standard Revetment and Erosion Stone Properties

Standard Classification	d_{50} Weight (lbs)	Average d_{50} Diameter ¹ (feet)	Maximum Weight (lbs)	Avg. max. Diameter ¹ (feet)
Class A Revetment Stone	125 ²	1.1 ²	400	1.7
Class B Revetment Stone	275	1.5	650	2.0
Class D & E Revetment Stone	90	1.0	250	1.4
Erosion Stone	---	0.5	---	0.75

¹ Diameters based upon an assumed specific gravity of 2.65.

² Approximate values for design purposes. Actual d_{50} value is not specified. ($d_{75} = 75$ lbs).

3. **Apron Length:** A sufficient length of protection must be provided in order to reduce the velocity and energy of the flow to the level anticipated in the downstream channel. This length is dependent on the volume and velocity of the flow at the discharge point. It is also dependent on the tailwater condition of the downstream channel. The length, L_a , is found from Figure 7E-10.03 or 7E-10.04 for the appropriate tailwater condition.

From the intersection of discharge and pipe diameter, or for velocity and flow depth found in the previous step, a vertical line is projected to the appropriate discharge depth/pipe diameter in the upper set of curves. From this intersection, a horizontal line is projected to the left to determine the minimum length of rock protection required.

4. **Apron Width:** For pipes that discharge into a well-defined channel, the width of the apron should extend to the top of the bank, or at least 1-foot above the maximum tailwater depth, whichever is less, along the entire length of the apron.

For outlets that discharge onto flat areas, the width of the apron at the upstream end of the culvert should be three times the diameter of the pipe, or equal to the width of the concrete pipe apron if one is provided. The width of the apron at the downstream end should be equal to the length of the apron, L_a , plus the diameter of the pipe, D .

5. **Apron Depth:** The depth of the apron should be equal to one and one-half times the maximum stone diameter (see Table 7E-10.01 for maximum diameter).

The channel downstream of the rock apron must be analyzed to ensure that existing or proposed channel liner is sufficient and that it will not be eroded under the anticipated flow depths. Methods for analyzing channel liners can be found in [Section 7E-23](#).

C. Application

Outlet protection should be considered at all pipe and culvert outlets. Rip rap is an easily constructed method of protection and is sufficient for many situations.

D. Maintenance

After installation, rock aprons should be inspected regularly. Special attention should be paid to the end of the apron, as it transitions to a natural channel. If scour or erosion is occurring at this junction, the apron should be extended, and additional stabilization methods may be required.

Figure 7E-10.01: Rip Rap Apron for Pipe Outlet into Channel
 (SUDAS Specifications Figure 9040.111)

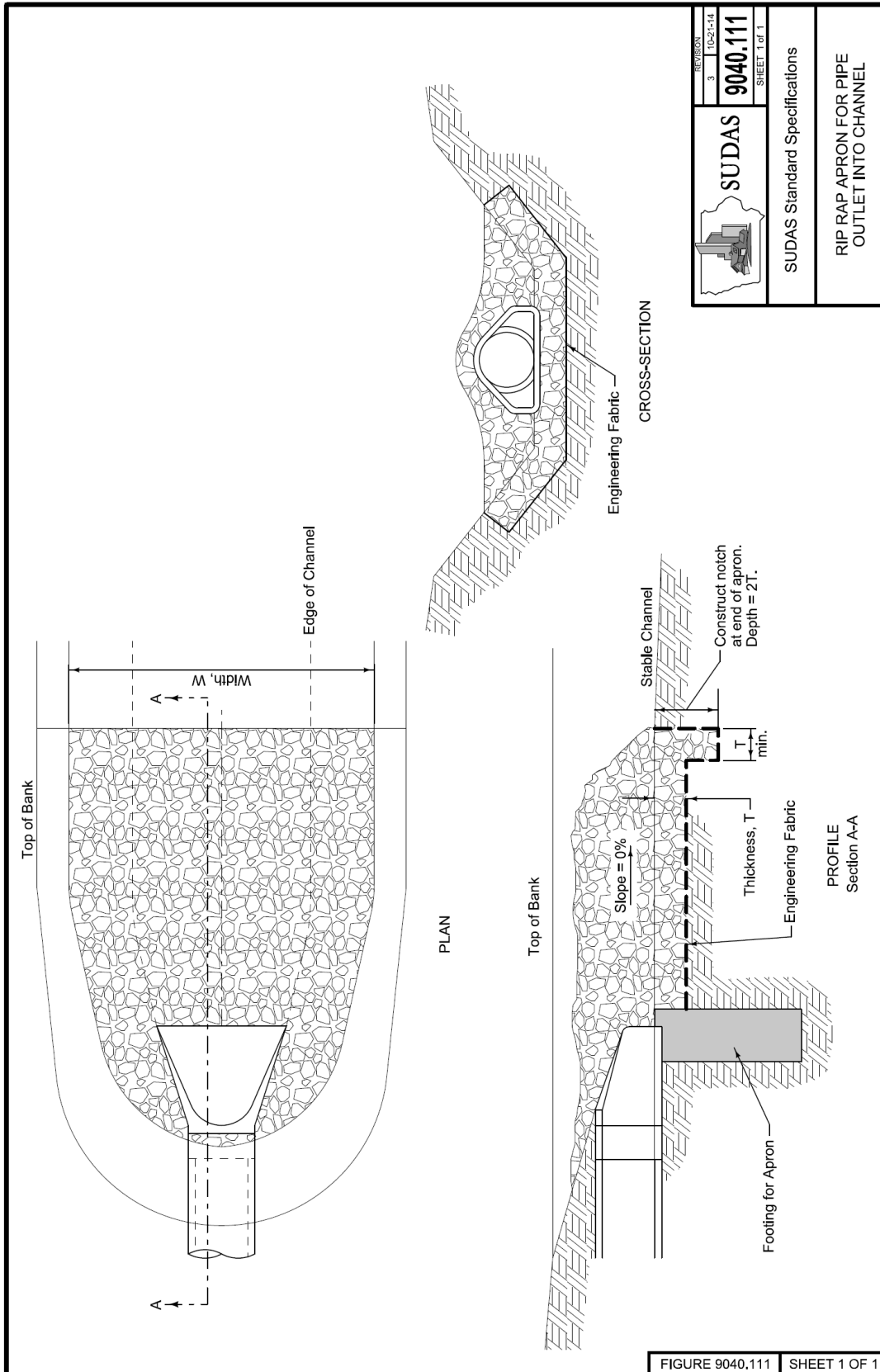

Figure 7E-10.02: Rip Rap Apron for Pipe Outlet onto Flat Ground
 (SUDAS Specifications Figure 9040.110)

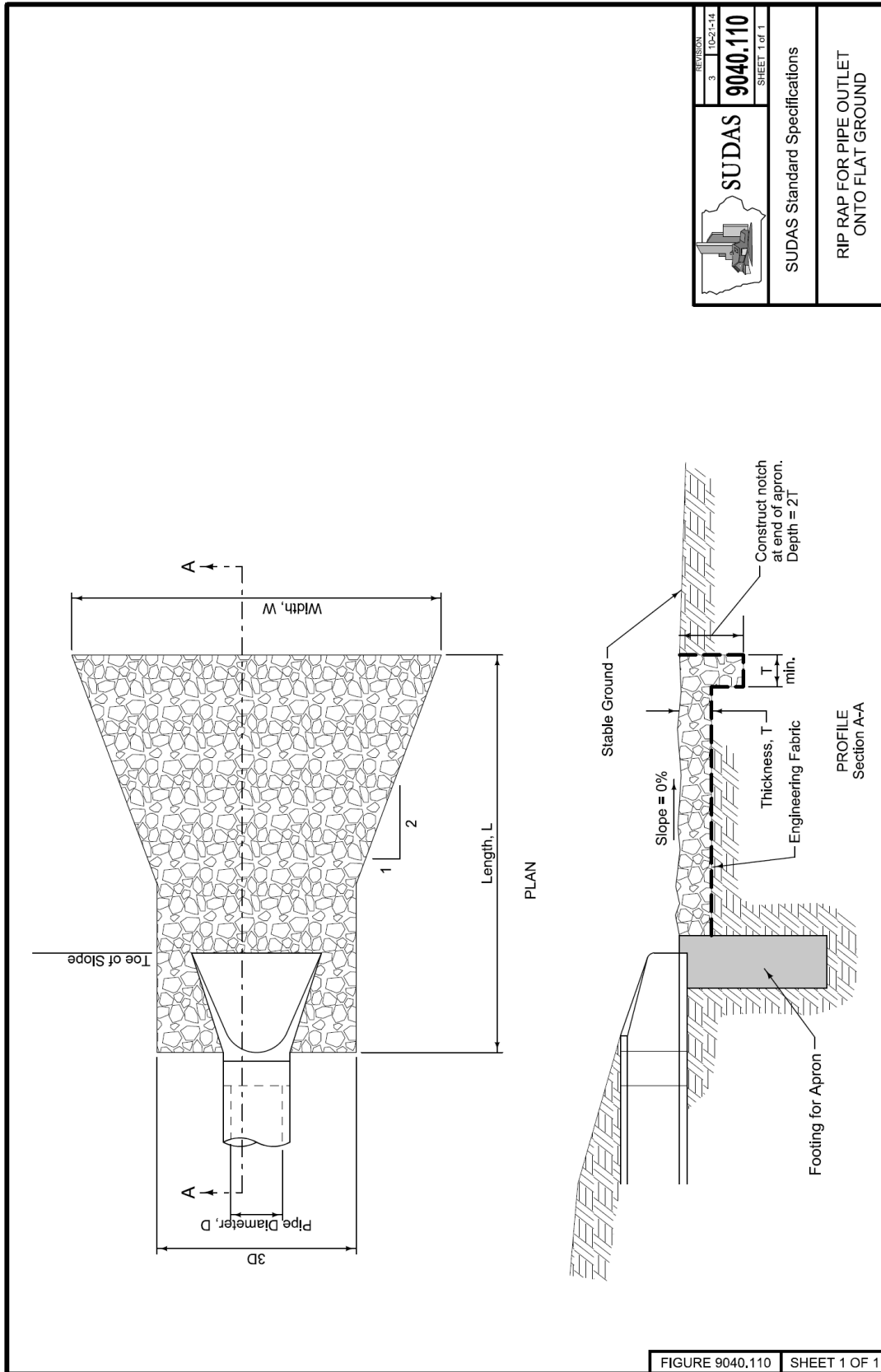
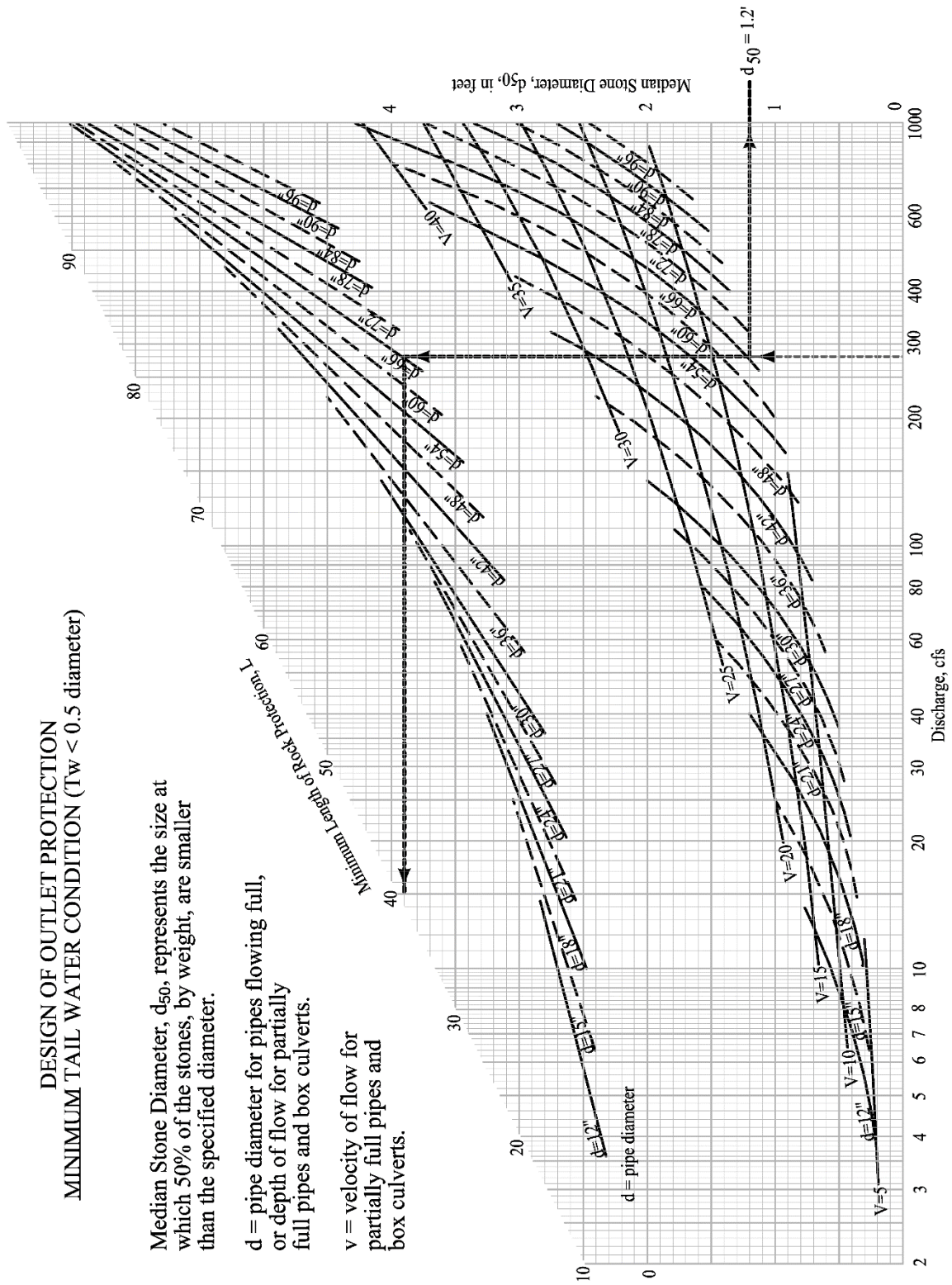
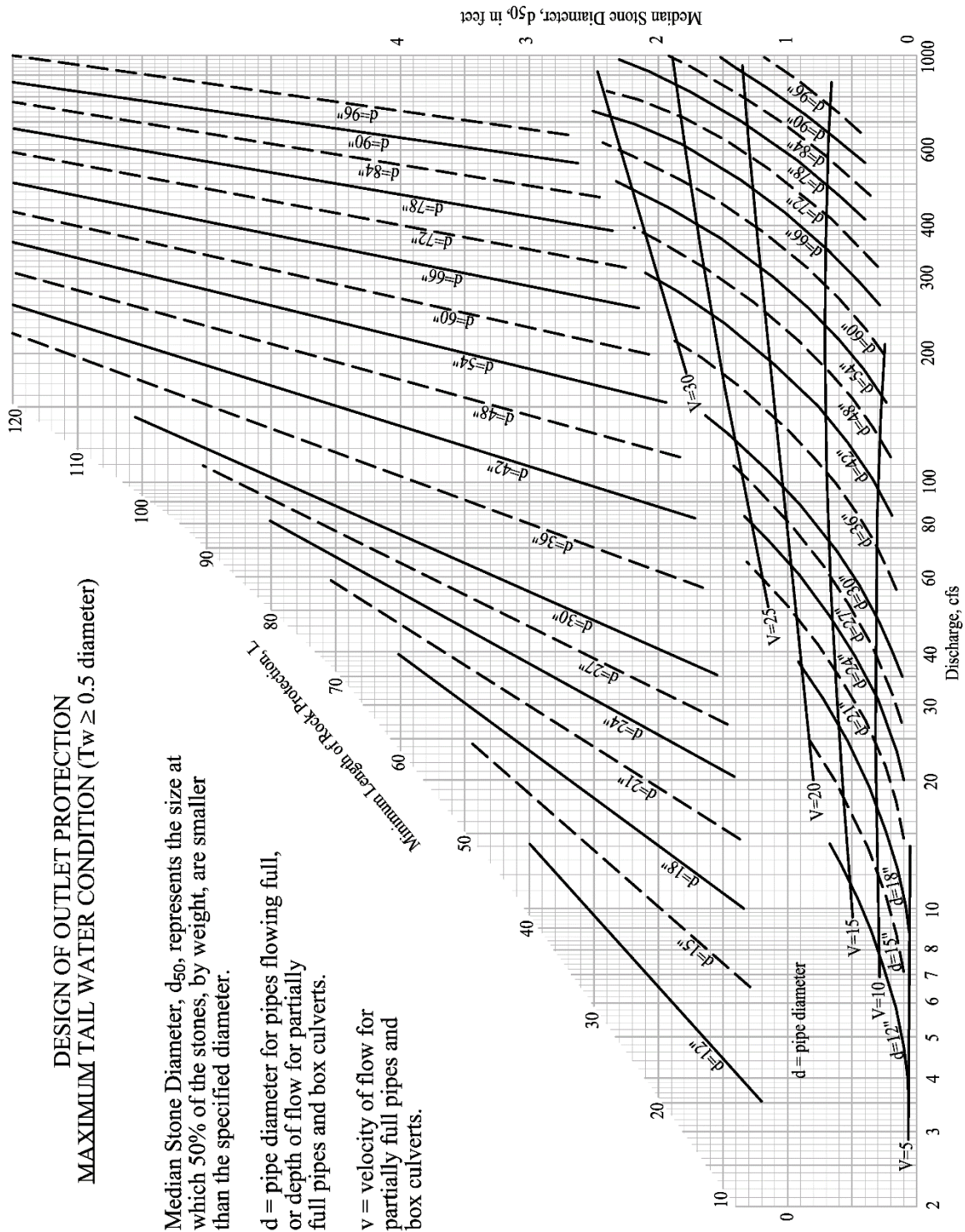

Figure 7E-10.03: Design of Outlet Protection, Minimum Tailwater Condition



Source: USDA NRCS, 2004

Figure 7E-10.04: Design of Outlet Protection, Maximum Tailwater Condition



Source: USDA NRCS, 2004

Temporary Pipe Slope Drains



<u>BENEFITS</u>			
	L	M	H
Flow Control	<input type="checkbox"/>	<input type="checkbox"/>	<input type="checkbox"/>
Erosion Control	<input type="checkbox"/>	<input type="checkbox"/>	<input type="checkbox"/>
Sediment Control	<input type="checkbox"/>	<input type="checkbox"/>	<input type="checkbox"/>
Runoff Reduction	<input type="checkbox"/>	<input type="checkbox"/>	<input type="checkbox"/>
Flow Diversion			

Description: Temporary slope drains consist of a pipe or tubing, installed from the top to the bottom of a disturbed slope. The drain transports concentrated runoff down the slope to a stabilized outlet, reducing the potential for erosion caused by runoff flowing over the disturbed slope.

Typical Uses: Used to transport concentrated runoff collected by a diversion structure, down a slope to a stable outlet or channel.

Advantages:

- Highly effective method for transporting runoff down a disturbed slope with minimal erosion.
- Easily constructed.
- Materials may be reused.

Limitations:

- Area around drain inlet must be carefully constructed to prevent water from flowing along the pipe, and breaching the diversion.
- The drain outlet must be discharged to a stable area, or outlet protection must be provided.

Longevity: Temporary, until vegetation is established

SUDAS Specifications: Refer to [Section 9040, 2.10](#) and [3.14](#)

A. Description/Uses

Temporary slope drains are constructed of flexible pipe or tubing, running from the top to the bottom of a disturbed slope. Slope drains provide a means of transporting collected runoff from the top of the slope to the bottom of the slope and prevent the erosive potential created by concentrated runoff flowing over the face of a disturbed slope.

Slope drains are commonly used in conjunction with diversion structures. A diversion structure at the top of the slope collects upland runoff and transports it to the desired outlet point. The slope drain provides an outlet for the diversion structure, safely carrying the collected runoff down the slope.

After grading, slopes are highly susceptible to erosion caused by sheet and concentrated flows from upland areas. Stabilizing the slope by seeding can be difficult as runoff over the slope may wash away seed and seedlings. Slope drains are used as a temporary measure to transport runoff down a slope, until the slope can be permanently stabilized. Eliminating flows over the face of a slope reduces erosion and provides newly planted seed an opportunity to establish itself without being washed away.

B. Design Considerations

Temporary slope drains should be sized to carry a two-year storm event. Table 7E-11.01 provides a summary of recommended pipe diameters based upon the contributing drainage area.

Table 7E-11.01: Slope Drain Diameters by Drainage Area

Maximum Drainage Area (acre)	Minimum Pipe Diameter (inches)
0.5	8
1.0	10
1.5	12
2.5	15
4	18
5	21
> 5	Special Design Required

Note: Values assumed a 2 year storm, 15 minute T_c , and a runoff coefficient of 0.5

Slope drains are normally installed in conjunction with diversion structures. The diversion structure should have a height or depth at the pipe inlet of at least 18 inches, or 6 inches greater than the pipe diameter, whichever is larger. The soil under and around the inlet of the pipe should have a low permeability, and be carefully compacted to ensure that seepage does not occur along the pipe-soil interface. The area around the inlet should be graded to ensure that flows are directed toward the pipe inlet.

The slope drain should have a minimum grade of 3%. A metal or flexible apron should be provided at the inlet of the pipe. If the area draining to the diversion and slope drain is disturbed, the slope drain should outlet to a sediment trap or sediment basin. If the upland area is undisturbed, the pipe outlet should bypass any sediment basins or traps, and drain to a stabilized area.

Unless the pipe drains to a stable outlet, protection such as rip rap or a rolled erosion control product may be required at the outlet.

Figure 7E-11.01: Temporary Pipe Slope Drain
 (SUDAS Specifications Figure 9040.112)

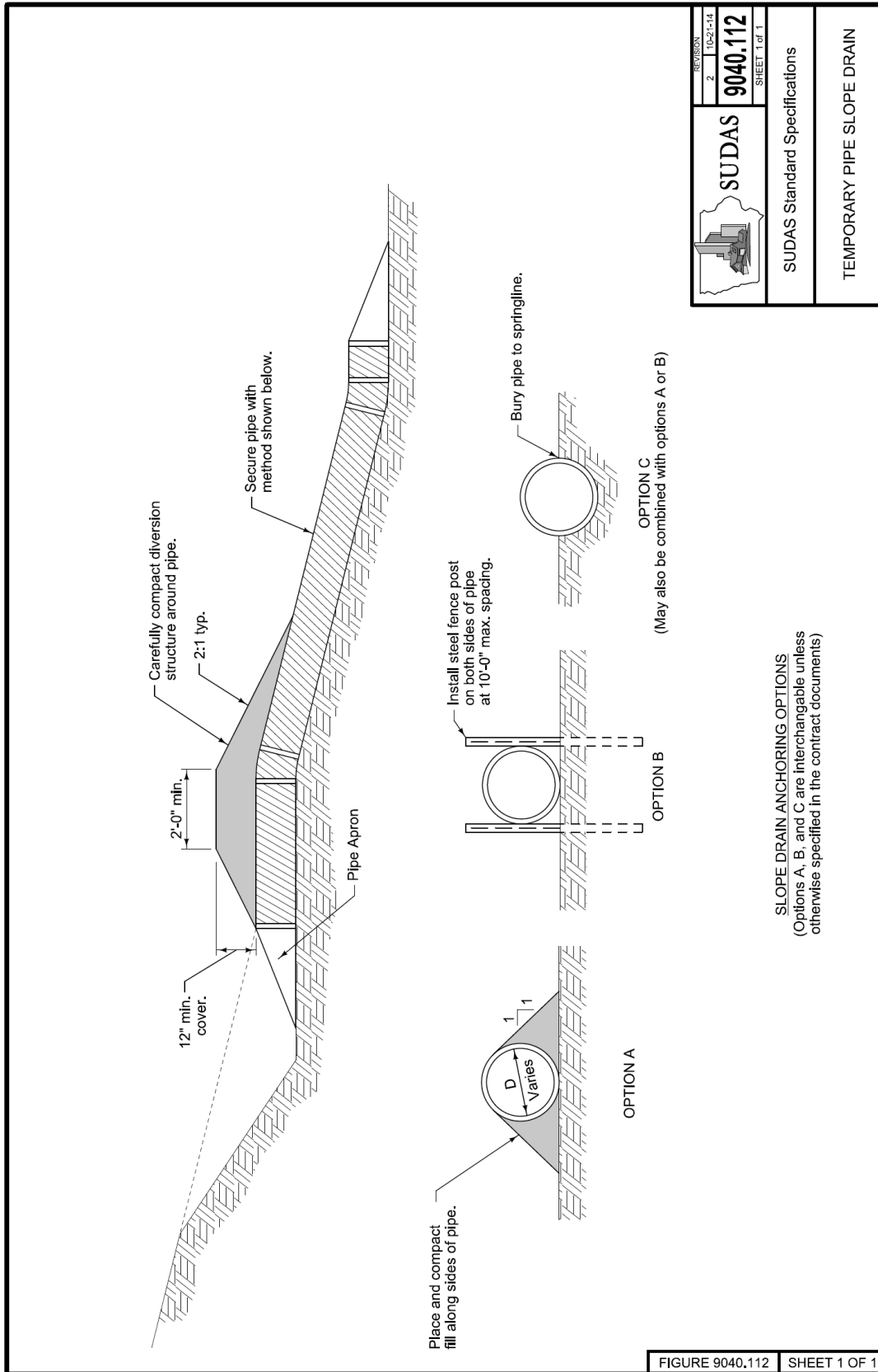

C. Application

Slope drains should be considered whenever a diversion structure is constructed on a disturbed slope steeper than 3%. When properly incorporated, diversion structures with slope drains provide a method to separate runoff from disturbed and stabilized areas, reducing the size requirements for sediment basins or traps.

D. Maintenance

The slope drain should be inspected for signs of leaking joints, pipe movement, erosion at the inlet and outlet, and seepage through the berm at the inlet.

E. Design Example

Assume the runoff from 7.5 acres of bare ground is intercepted by a diversion structure and carried to the location of a proposed slope drain. Determine the required diameter of the slope drain.

Using the techniques described in Chapter 2 - Stormwater, the following information is determined:

Time of Concentration, $T_c = 15$ minutes

Rainfall Intensity, $I = 3.48$ (Region 7)

Runoff Coefficient for bare ground, $C = 0.5$.

Using this information, the peak runoff is found to be 13.1 cfs by the Rational Method.

The minimum pipe diameter is found with the orifice equation (assume head to top of pipe).

$$Q = (0.6)(A)\sqrt{2gh}$$

Where:

- Q = Runoff volume, cfs
- A = Area of pipe opening
- g = Acceleration of gravity, 32.2 ft/s²
- h = Head pressure (h=D/2 for head to top of pipe)

$$13.1 = (0.6)\left(\frac{\pi \times D^2}{4}\right)\sqrt{2 \times 32.2 \times \frac{D}{2}}, \text{ Solving for } D \text{ yields a diameter of } 1.9' \text{ or } 23 \text{ inches.}$$

Conclusion: Based upon the analysis, a 24 inch diameter pipe would be selected.

Sediment Basin



<u>BENEFITS</u>			
	L	M	H
Flow Control			
Erosion Control			
Sediment Control			
Runoff Reduction			
Flow Diversion			

Description: Sediment basins, like sediment traps, are temporary structures that are used to detain sediment-laden runoff long enough to allow a majority of sediment to settle out. Sediment basins are larger than sediment traps, serving drainage areas between 5 and 100 acres.

Sediment basins use a release structure to control the discharge, and normally have an emergency spillway to release the flow from larger storms. If properly planned, the basins may also serve as permanent stormwater management facilities, such as detention basins or permanent sediment removal structures.

Typical Uses: Used below disturbed areas where the contributing drainage area is greater than 5 acres. Basins require significant space and the appropriate topography for construction.

Advantages:

- Can greatly improve the quality of runoff being released from a site by removing suspended sediment on a large-scale basis.
- May be designed as a permanent structure to provide future detention, or for long-term water quality enhancement.

Limitations:

- Large in both area and volume.
- Use is somewhat dependent on the topography of the land.
- Must be carefully designed to account for large storm events.
- Not to be located within live streams.
- May require protective fencing.

Longevity: 18 months; may be converted to a permanent feature

SUDAS Specifications: Refer to [Section 9040, 2.11](#) and [3.15](#)

A. Description/Uses

Sediment basins, like sediment traps, are temporary structures used to detain runoff so sediment will settle before it is released. Sediment basins are much larger than sediment traps, serving drainage areas up to 100 acres. If properly planned and designed, sediment basins can be converted to permanent stormwater management facilities upon completion of construction.

B. Design Considerations

Adequate storage volume is critical to the performance of the basin. Sediment basins that are undersized will perform at much lower removal efficiency rates. Sediment basin volumes and dimensions should be sized according to the criteria in [Section 7D-1](#).

A sediment basin consists of several components for releasing flows: a principal spillway, a dewatering device, and an emergency spillway. The principal spillway is a structure which passes a given design storm. It also contains a de-watering device that slowly releases the water contained in the temporary dry storage. An emergency spillway may also be provided to safely pass storms larger than the design storm.

- 1. Principal Spillway:** The principal spillway consists of a vertical riser pipe connected at the base to a horizontal outlet pipe. The outlet pipe carries water through the embankment and discharges beyond the downstream toe of the embankment.

The first step in designing a principal spillway is to set the overflow elevation of the riser pipe. The top of the riser should be set at an elevation corresponding to a storage volume of 3,600 cubic feet per acre of disturbed ground. When an emergency spillway is provided, this elevation should be a minimum of 1 foot below the crest of the emergency spillway. If no emergency spillway is used, the top of the riser should be set at least 3 feet below the top of the embankment.

The next step is to determine the size of the riser and outlet pipes required. These pipes are sized to carry the peak inflow, Q_p , for the design storm. If an emergency spillway will be included, the principal spillway should be designed to handle the peak inflow for a 2 year, 24 hour storm, without exceeding the elevation of the emergency spillway. If an emergency spillway is not included, the principal spillway must be designed to pass the 25 year storm, with at least 2 feet of clearance between the high-water elevation and the top of the embankment. Peak inflow flow rates should be determined according to the methods described in [Chapter 2 - Stormwater](#). The peak rate should account for the lack of vegetation and high runoff potential that is likely to occur during construction.

The riser size can be determined using the following equations. The flow through the riser should be checked for both weir and orifice flow. The equation, which yields the lowest flow for a given head, is the controlling situation.

$$\begin{array}{ll} \text{Weir Flow} & \text{Orifice Flow} \\ Q = 10.5 \times d \times h^{\frac{3}{2}} & Q = 0.6 \times A \times \sqrt{2gh} \end{array} \quad \text{Equations 7E-12.01 and 7E-12.02}$$

Where:

- Q = Inlet capacity of riser, cfs
- d = Riser diameter, ft
- h = Allowable head above top of riser, ft
- A = Open area of the orifice, ft²
- g = Acceleration of gravity, (32.2 ft/s²)

The allowable head is measured from the top of the riser to the crest of the emergency spillway or to the crest of the embankment if no emergency spillway is provided.

Figure 7E-12.01: Sediment Basin Without Emergency Spillway
 (SUDAS Specifications Figure 9040.113)

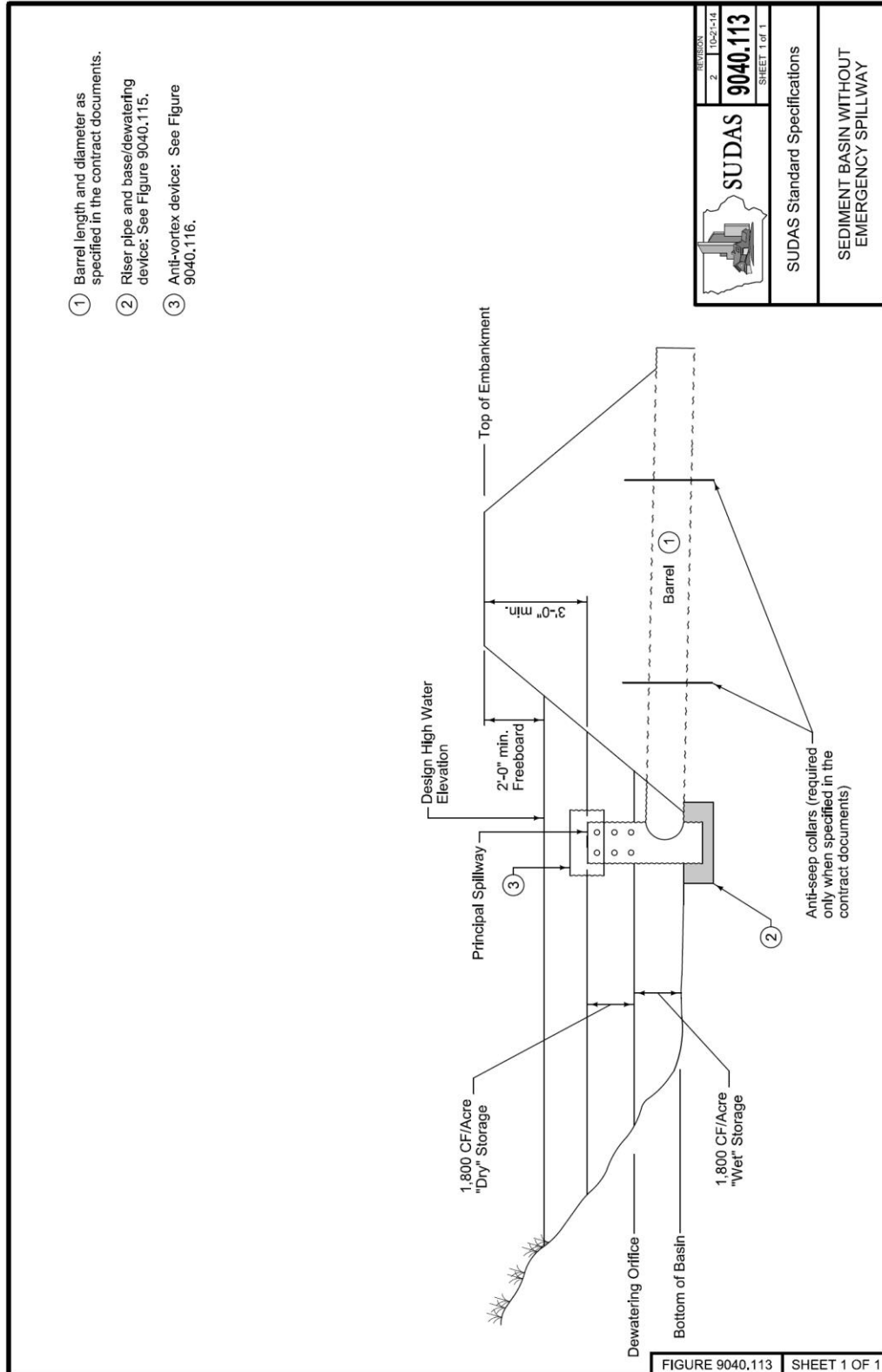
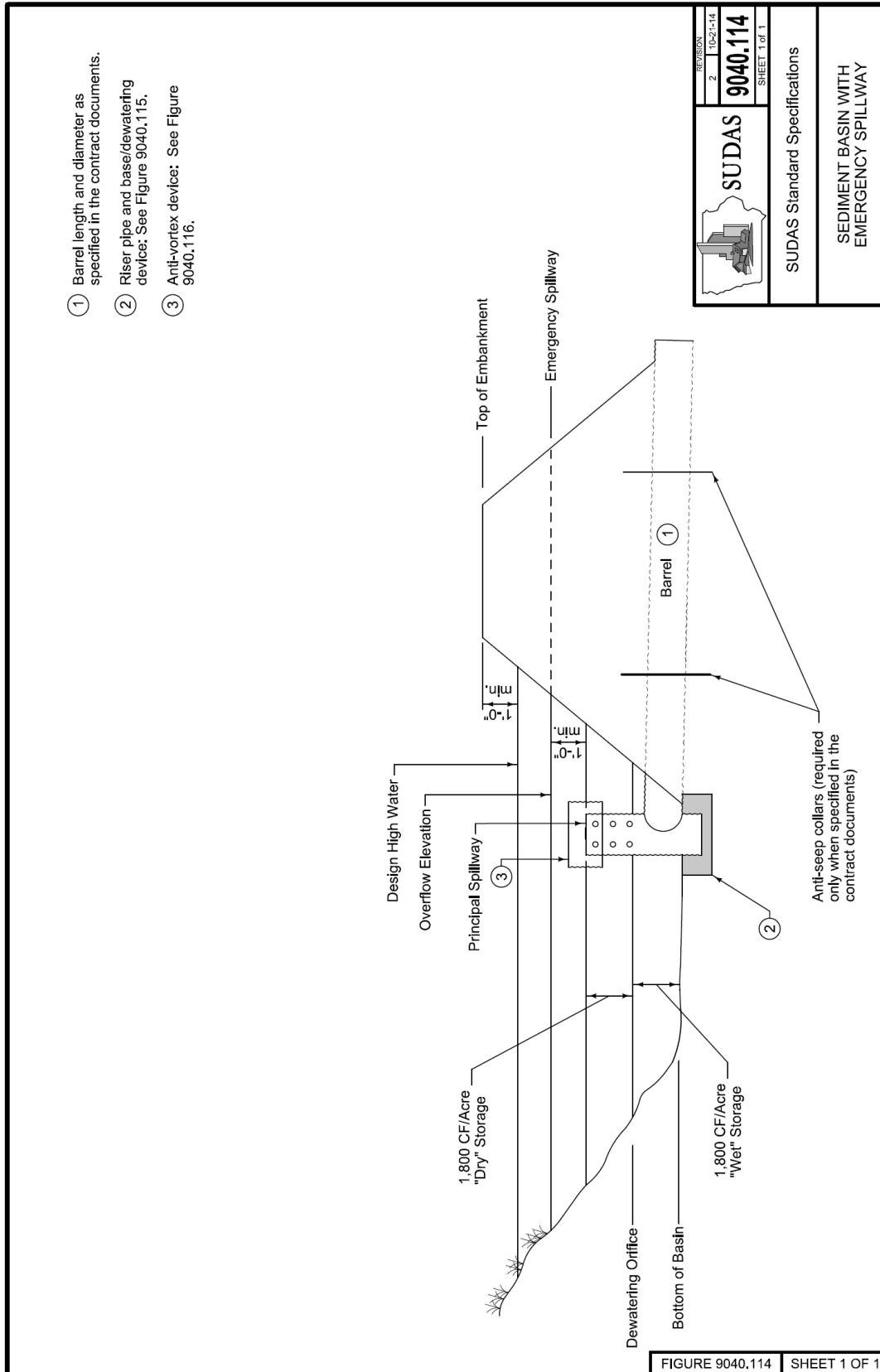

Figure 7E-12.02: Sediment Basin With Emergency Spillway
 (SUDAS Specifications Figure 9040.114)



2. **Outlet Barrel:** The size of the outlet barrel is a function of its length and the total head acting on the barrel. This head is the difference in elevation of the centerline of the outlet of the barrel and maximum elevation of the water (design high water). The size of the outlet barrel can be determined using [Chapter 2 - Stormwater](#) for culvert design.
3. **Anti-vortex Device:** An anti-vortex device should be installed on top of the riser section to improve flow characteristics of water into the principal spillway, and prevent floating debris from blocking the spillway.

There are numerous ways to provide protection for concrete pipe including various hoods, grates, and rebar configurations that are part of the project-specific design, and will frequently be part of a permanent structure.

The design information provided in the following detail and table are for corrugated metal riser pipes.

Figure 7E-12.03: Example Anti-vortex Device
 (SUDAS Specifications Figure 9040.116, sheet 1)

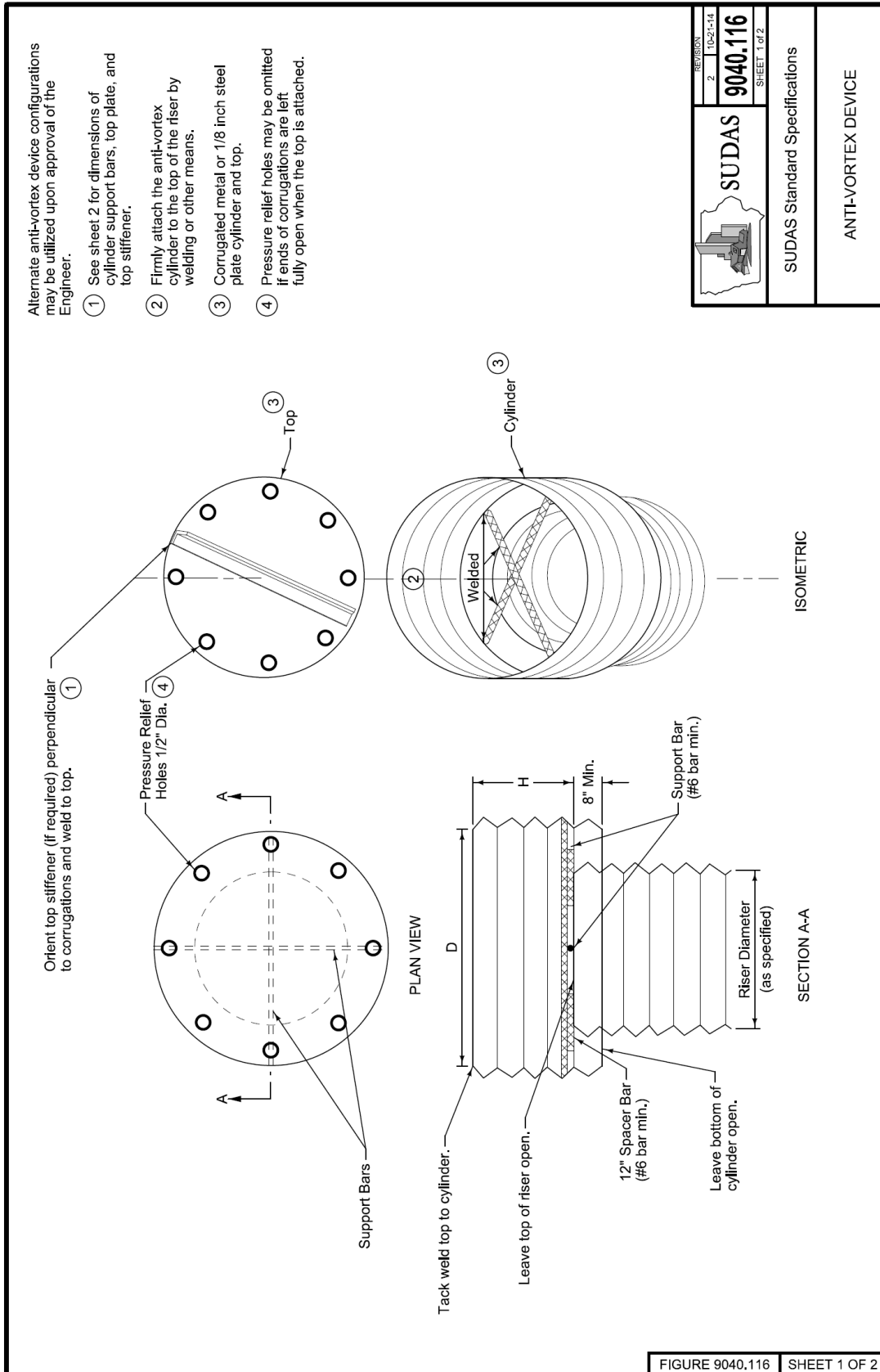

	REVISION	2	10-21-14
	9040.116 SHEET 1 of 2		
SUDAS Standard Specifications			
ANTI-VORTEX DEVICE			

Table 7E-12.01: Design Information for Anti-vortex and Trash Rack Device
([SUDAS Specifications Figure 9040.116, sheet 2](#))

RISER Diameter (in.)	CYLINDER				MINIMUM TOP	
	Diameter (in.)	Thickness (gage)	Height (H) (in.)	Minimum Size Support Bar	Thickness	Stiffener
12	18	16	6	#6 rebar or 1 1/2" X 3/16" angle	16 ga F & C	---
15	21	16	7	#6 rebar or 1 1/2" X 3/16" angle	16 ga F & C	---
18	27	16	8	#6 rebar or 1 1/2" X 3/16" angle	16 ga F & C	---
21	30	16	11	#6 rebar or 1 1/2" X 3/16" angle	16 ga (C), 14 ga (F)	---
24	36	16	13	#6 rebar or 1 1/2" X 3/16" angle	16 ga (C), 14 ga (F)	---
27	42	16	15	#6 rebar or 1 1/2" X 3/16" angle	16 ga (C), 14 ga (F)	---
36	54	16	17	#8 rebar	14 ga (C), 12 ga (F)	---
42	60	16	19	#8 rebar	14 ga (C), 12 ga (F)	---
48	72	16	21	1 1/4" pipe or 1 1/4" X 1 1/4" X 1/4" angle	14 ga (C), 10 ga (F)	---
54	78	16	25	1 1/4" pipe or 1 1/4" X 1 1/4" X 1/4" angle	14 ga (C), 10 ga (F)	---
60	90	14	29	1 1/2" pipe or 1 1/2" X 1 1/2" X 1/4" angle	12 ga (C), 8 ga (F)	---
66	96	14	33	2" pipe or 2" X 2" X 1/4" angle	12 ga (C), 8 ga (F)	2" X 2" X 1/4" angle
72	102	14	36	2" pipe or 2" X 2" X 1/4" angle	12 ga (C), 8 ga (F)	2 1/2" X 2 1/2" X 1/4" angle
78	114	14	39	2 1/2" pipe or 2" X 2" X 1/4" angle	12 ga (C), 8 ga (F)	2 1/2" X 2 1/2" X 1/4" angle
84	120	12	42	2 1/2" pipe or 2" X 2" X 1/4" angle	12 ga (C), 8 ga (F)	2 1/2" X 2 1/2" X 5/16" angle

Notes:

- The criterion for sizing the cylinder is that the area between the inside of the cylinder and the outside of the riser is equal to or greater than the area inside the riser. Therefore, the above table is invalid for use with concrete pipe risers.
- C - Corrugated F - Flat.

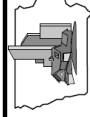
The riser pipe needs to be firmly attached to a base that has sufficient weight to prevent flotation of the riser. The weight of the base should be designed to be at least 1.25 times greater than the buoyant forces acting on the riser at the design high water elevation.

A base typically consists of a poured concrete footing with embedded anchors to attach to the riser pipe to anchor it in place.

- Dewatering Device:** The purpose of the dewatering device is to release the impounded runoff in the dry storage volume of the basin over an extended period of time. This slow dewatering process detains the heavily sediment-laden runoff in the basin for an extended time, allowing sediment to settle out. The dewatering device should be designed to drawdown the runoff in the basin from the crest of the riser to the wet pool elevation over a period of at least 6 hours.

Figure 7E-12.04: Theoretical Discharge Orifice for Design of Perforated Risers
(SUDAS Specifications Figure 9040.115)

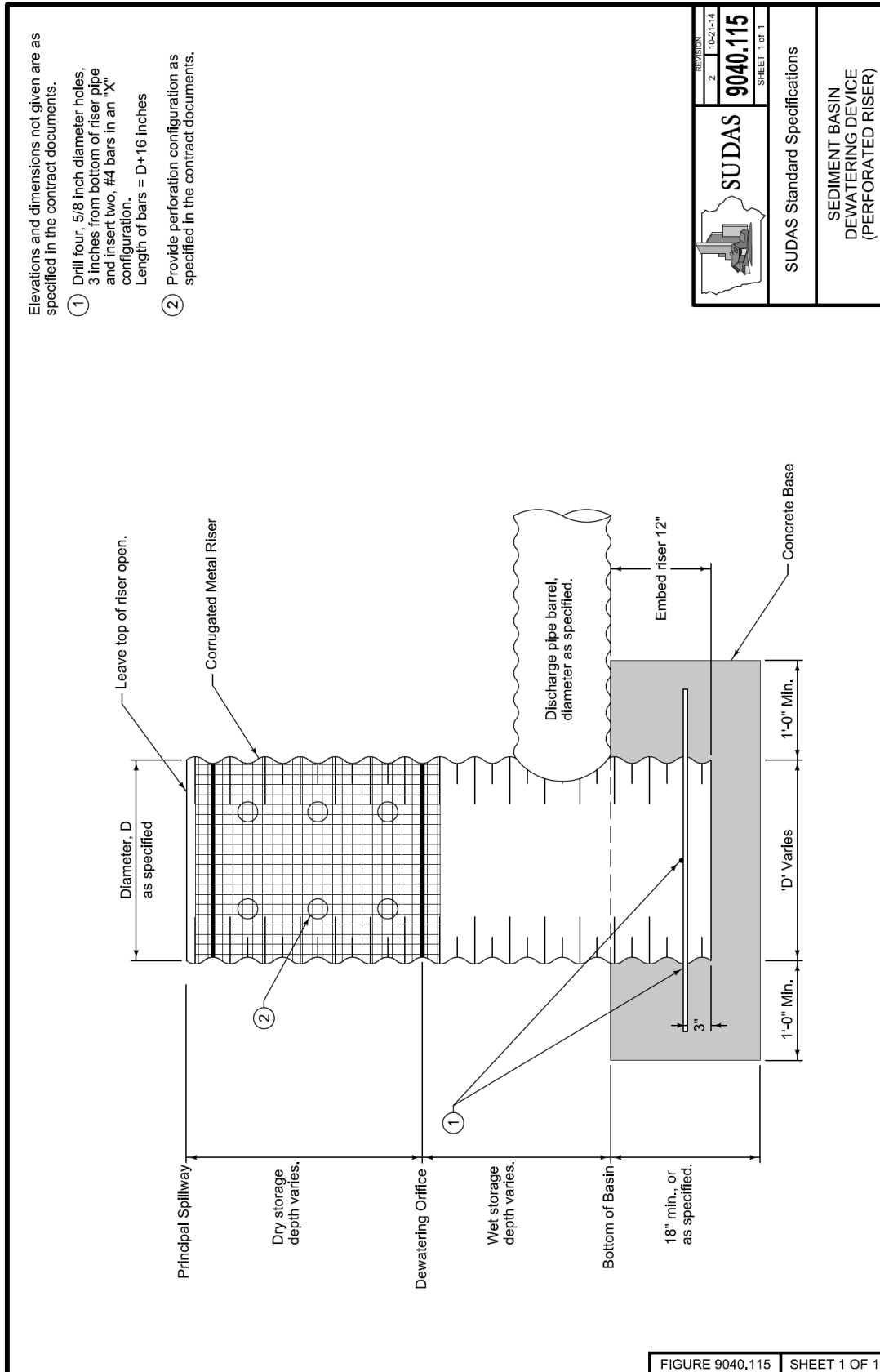

One common method of dewatering a sediment basin is to perforate the riser section to achieve the desired draw-down of the dry storage volume. Riser pipes with customized perforations to meet individual project requirements can be easily fabricated from a section of corrugated metal pipe. The contractor or supplier can drill holes of the size, quantity, and configuration specified on the plans. The lower row of perforations should be located at the permanent pool elevation (top of the wet storage volume). The upper row should be located a minimum of 3 inches from the top of the pipe (principal spillway elevation).

Dewatering device design begins by determining the average flow rate for a 6 hour drawdown time. Once the average discharge is known, the number and size of perforations required can be determined. To calculate the area of the perforations, a single rectangular orifice that extends from the wet pool elevation to the proposed elevation of the top row of holes (a minimum of 3 inches below the principal spillway) is assumed.

Next, the average head acting on the rectangular orifice as the basin is dewatered is determined. This average head is approximated by the following equation:

$$h_a = \frac{(h_p - h_c)}{2} \quad \text{Equation 7E-12.03}$$

Where:

- h_a = Average head during dewatering
- h_p = Maximum head (between the wet pool and principal spillway)
- h_c = Distance between the wet pool elevation and the centroid of the orifice, ft

Figure 7E-12.05: Theoretical Discharge Orifice for Design of Perforated Risers

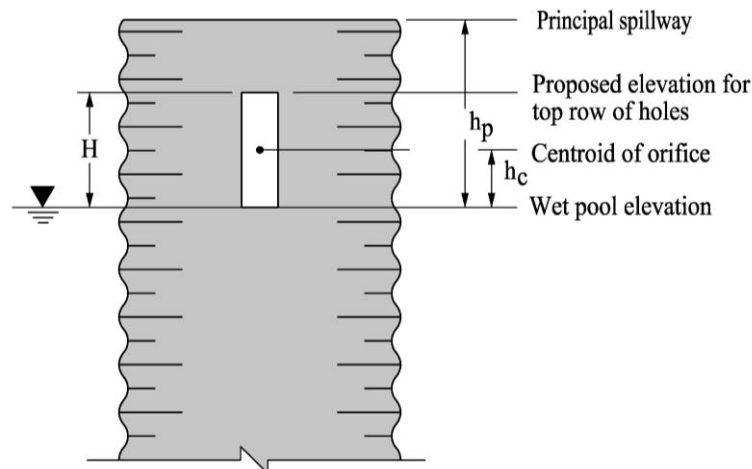

Once the average head is known, the area of the rectangular orifice is sized according to Equation 7E-12.04 to provide the average flow rate for the 6 hour drawdown. Providing evenly spaced perforations that have a combined open area equal to that of the calculated rectangular orifice, will provide the desired discharge rate for a 6 hour drawdown.

$$A = \frac{Q_a}{0.6 \times (2g \times h_a)^{1/2}}$$

Equation 7E-12.04

Where:

- A = Total area of the orifices, sf
- h_a = Average head acting on the orifice (Equation 7E-12.03)
- Q_a = Average flow rate required for 6-hour drawdown, cfs
- Q = S/21,600 sec. (6 hour drawdown only)
- S = Dry storage volume required, cf

The number and diameter of the holes is variable. The diameter selected should be a minimum of 1 inch to minimize clogging, and should be a multiple of 1/4 of an inch. The perforation configuration should consist of a minimum of three horizontal rows and two vertical columns of evenly spaced perforations. Selecting a combination of hole diameter and number of holes is a trial and error process. Once the configuration is determined, the required information should be specified on the plans.

An alternative to the traditional riser is to provide a skimmer device that floats on the surface of the water in the basin. The skimmer is made of a straight section of PVC pipe equipped with a float and attached with a flexible coupling to an outlet at the base of the riser. Because the skimmer floats, it rises and falls with the level of the water in the basin and drains only the cleanest top layer of runoff. Sediment removal rates from basins equipped with skimmers have been shown to be significantly more effective than with a perforated riser or orifice.

Skimming devices are normally proprietary. Discharge information should be obtained from the manufacturer.

Figure 7E-12.06: Example Skimmer for Drawdown of Wet Storage

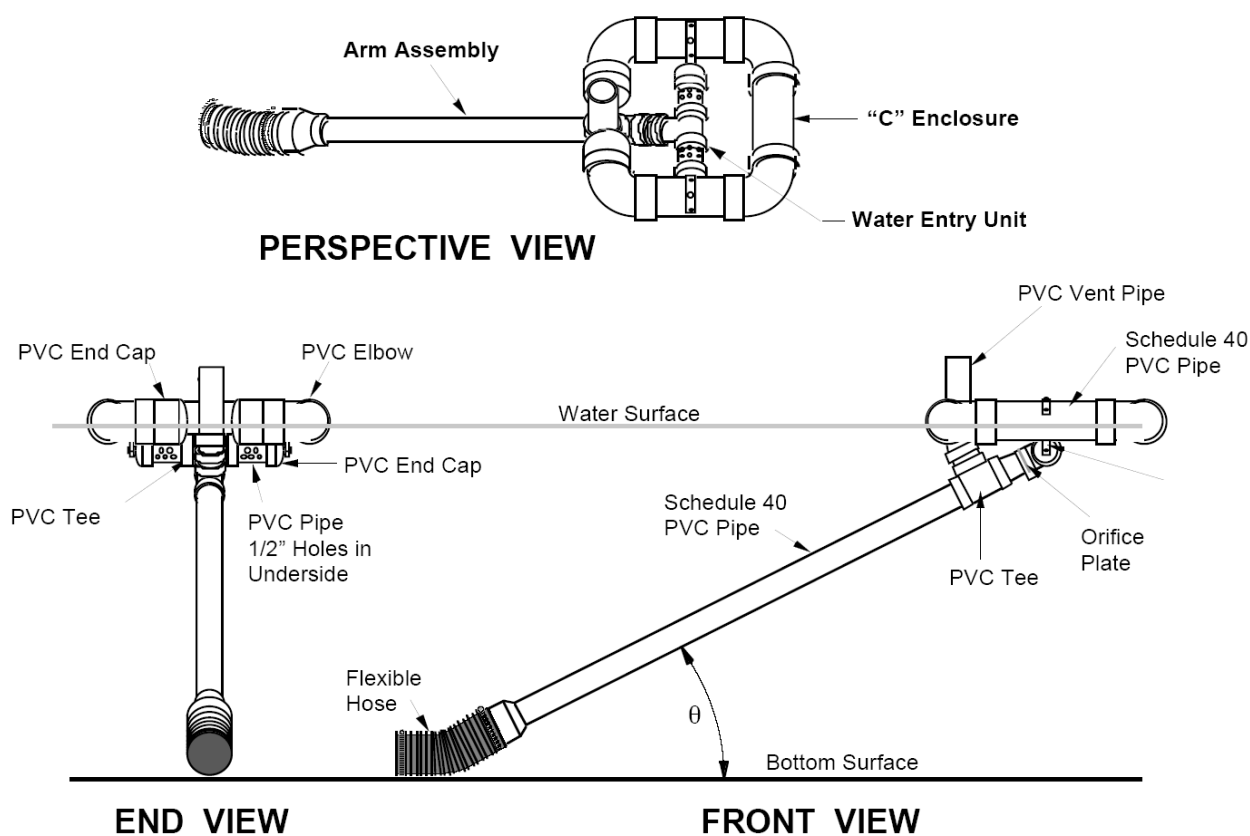

Source: Penn State University

- Emergency Spillway:** An emergency spillway acts as an overflow device for a sediment basin by safely passing the large, less frequent storms through the basin without damage to the embankment. It also acts in case of an emergency such as excessive sedimentation or damage to the riser that prevents flow through the principal spillway. The emergency spillway should consist of an open channel constructed adjacent to the embankment over undisturbed material, not fill. This channel should be stabilized with matting, seeding, or sodding.

Where conditions will not allow the construction of an emergency spillway on undisturbed material, the spillway may be constructed on top of the embankment and protected with non-erodible material such as erosion stone.

An evaluation of site and downstream conditions must be made to determine the feasibility of, and justification for, the incorporation of an emergency spillway. In some cases, the site topography does not allow a spillway to be constructed in undisturbed material, and the temporary nature of the facility may not warrant the cost of disturbing more acreage to construct and armor an emergency spillway. The principal spillway should then be sized to convey a 25 year storm event, providing 2 feet of freeboard between the design high water elevation and the top of the embankment. If the facility is designed to be permanent, the added expense of constructing and armoring an emergency spillway may be justified.

When an emergency spillway is required, it should be designed to safely pass the 25 year design storm with a minimum of one-foot clearance between the high water elevation and the top of the

basin embankment. Since the principal spillway is only designed to carry the 2 year event, the emergency spillway must carry the remainder of the 25 year event.

$$Q_e = Q_{25} - Q_p \qquad \text{Equation 7E-12.05}$$

Where:

- Q_e = Required emergency spillway capacity, cfs
- Q_{25} = 25-year, 24 hour peak flow, cfs
- Q_p = Principal spillway capacity at high water elevation, cfs

Based upon the flow requirements, Table 7E-12.01 can be used to determine the minimum width of the emergency spillway (b), the minimum slope of the exit channel (S), and the minimum length of the exist channel (X).

A control section at least 20 feet in length should be provided in order to determine the hydraulic characteristics of the spillway, according to Table 7E-12.01. The control section should be a level portion of the spillway channel at the highest elevation in the channel. If the length and slope of the exit channel indicated in Table 7E-12.01 cannot be provided, alternative methods of evaluating the spillway must be conducted.

Figure 7E-12.07: Typical Sediment Basin Emergency Spillway

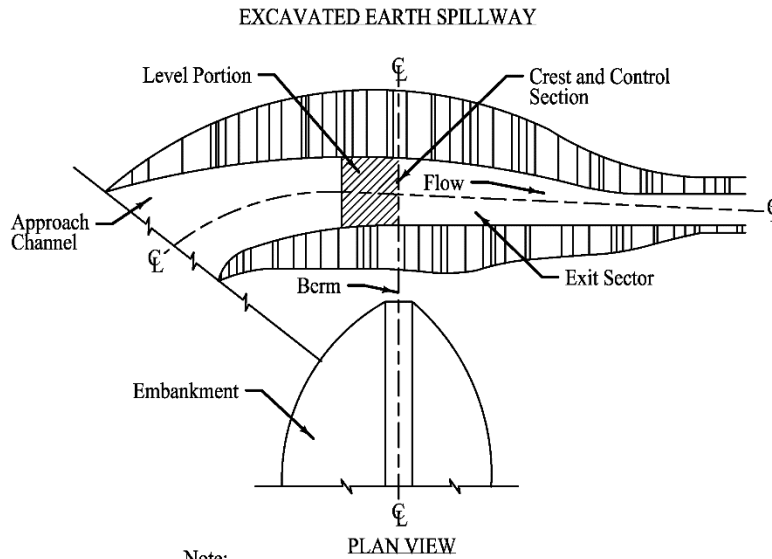

Note:

Neither the location nor alignment of the control section has to coincide with the centerline of the dam.

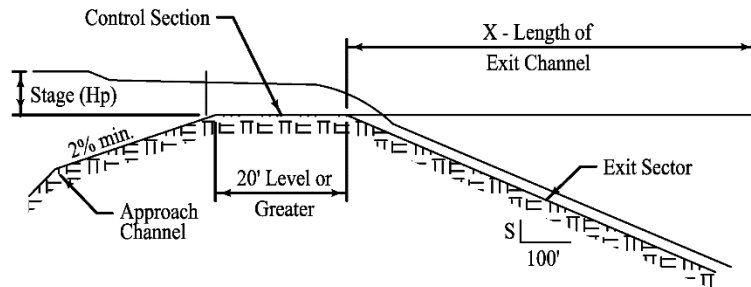

PROFILE ALONG CENTERLINE

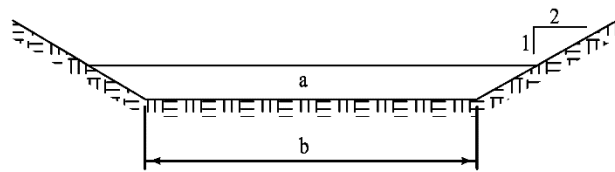

CROSS-SECTION

Source: Roberts, 1995

In addition to checking the capacity of the spillway, the discharge velocity should also be considered. The allowable velocity for vegetated channels or channels lined with a turf reinforcement mat should be carefully analyzed. See [Section 7E-23](#) and [7E-18](#) for information on permissible velocities. For non-erodible linings such as concrete or rip rap, design velocities may be increased.

- 5. Anti-seep Collars:** Anti-seep collars help prevent water from flowing along the interface between the outlet barrel and the embankment. This movement of water can, over time, destabilize the embankment, causing it to wash out or burst.

Anti-seep collars are not normally required for sediment basins. However, when the height of the embankment exceeds 10 feet, or the embankment material has a low silt-clay content, anti-seep collars should be used. Anti-seep collars should be used on all structures that may be converted to permanent features.

The first step in designing anti-seep collars is to determine the length of the barrel within the saturated zone. The length of the saturated zone is determined with the following:

$$L_s = Y(Z + 4) \left(1 + \frac{S}{0.25 - S} \right) \quad \text{Equation 7E-12.06}$$

Where:

- L_s = Length of the barrel within saturated zone, ft
 Y = Depth of water at principal spillway crest, ft
 Z = Slope of upstream face of embankment, Z ft H: 1 ft V.
 S = Slope of the barrel in ft per ft

An increase in the seepage length along the barrel of 10% should be provided. Determine the length required to achieve this by multiplying L_s by 10% ($0.10L_s$). This increase in length represents the total collar projection. This can be provided for by one or multiple collars.

Choose a collar size that is at least 4 feet larger than the barrel diameter (2 feet in all directions). Calculate the collar projection by subtracting the pipe diameter from the collar size. Then determine the number of collars required by dividing the seepage length increase ($0.10L_s$) by the collar projection. To reduce the number of collars required, the collar size can be increased. Alternatively, providing more collars can decrease the collar size.

Collars should be placed at a maximum spacing of 14 times the minimum projection above the pipe, and a minimum spacing of 5 times the minimum projection. All collars should be located within the saturated zone. If spacing will not allow this, at least one collar should be located within the saturated zone.

Alternative methods of controlling seepage, such as a filter diaphragm may also be acceptable. A filter diaphragm consists of a layer of porous material running perpendicular to the outlet barrel which intercepts and controls water movement and fines migration within the embankment.

Figure 7E-12.08: Anti-seep Collar
 (SUDAS Specifications Figure 9040.117)

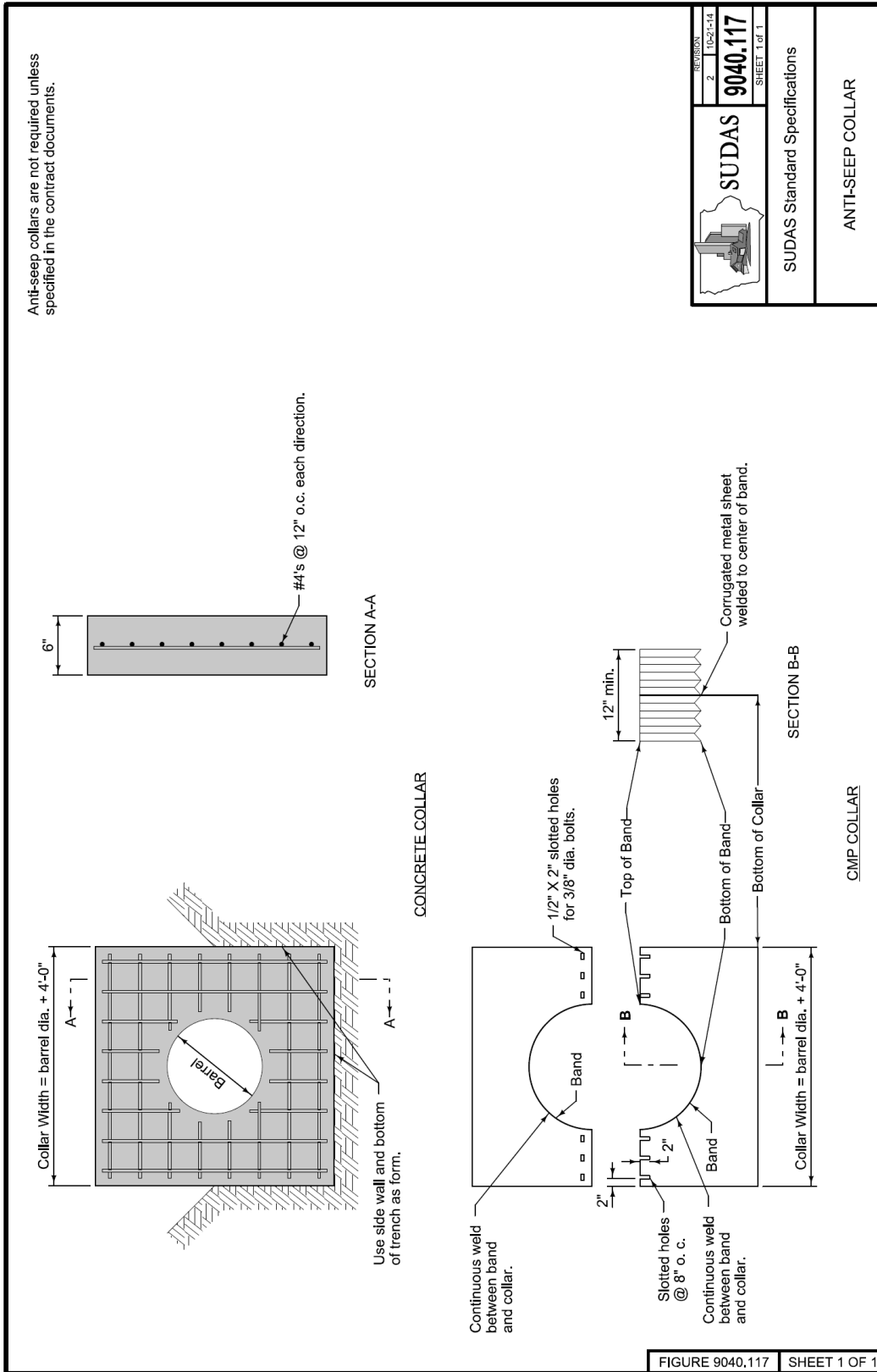

Source: Adapted from Virginia DCR, 1999

7. **Safety Fence:** Depending on the depth, location, and local ordinances, a safety fence and appropriate signing may be required around the sediment basin.
8. **Additional Considerations:** Sediment basins which are more than 10 feet high, or which have storage capacities in excess of 10 acre-feet may require review and approval from the Iowa DNR per IAC 567-71.3. A vast majority of temporary sediment basins will not fall under these regulations. Basins that are intended to become permanent features are more likely to require this review.

C. Application

Sediment basin volumes and dimensions should be sized according to the criteria in [Section 7D-1](#). Sediment basins are normally required for disturbed drainage areas of 10 acres or greater.

D. Maintenance

Maintenance and cleanout frequencies for sediment basins depend greatly on the amount of precipitation and sediment load arriving at the basin. During inspections, the embankment should be reviewed for signs of seepage, settlement, or slumping. These problems should be repaired immediately. Sediment should be removed from the basin when it accumulates to one-half of the wet storage volume.

During sediment cleanout, trash should be removed from the basin, and the dewatering device and riser pipe should be checked and cleared of any accumulated debris.

E. Design Example

Assume a construction site has 12 acres of disturbed ground which drains to a common location. In addition, 8 acres of off-site area drains through the construction site. Due to site restrictions, the 8 acres of off-site drainage cannot be routed around the site. Design a temporary sediment basin, with an emergency spillway, to handle and treat the runoff from the 20 acre site.

Solution:

1. **Basin Volume:** The Iowa DNR NPDES General Permit No. 2 requires a minimum storage volume of 3,600 cubic feet of storage per acre drained.

Therefore: 20 acres x 3,600 cf = 72,000 cf.

According to [Section 7D-1, D, 3](#), this volume should be split equally between wet and dry storage (36,000 cf each).

For the remaining calculations, assume that a basin has been sized and laid out to provide the following elevations:

Elevation A (Bottom of Basin) = 100
Elevation B (Wet Storage) = 103.0
Elevation C (Dry Storage) = 105.0
Elevation D (Invert of emergency spillway) = 106.5
Elevation E (Top of embankment) = 108.5

2. **Size the Principal Spillway (Riser):** From TR-55, using the methods described in [Chapter 2 - Stormwater](#), assume the peak inflow from the 2 year, 24 hour storm is 41 cfs.

In order to determine the required diameter of the principal spillway, the available head elevation above the spillway must be determined. From the elevation information provided above, the principal spillway is at elevation 105.0, and the invert of the emergency spillway is at elevation 106.5. Based upon this, the allowable head is 1.5 feet (106.5-105.0).

The diameter of principal spillway (riser) is found by trial and error process, with the weir and orifice equations:

Try a 24 inch diameter riser: (d=2 ft, A=3.14 ft²)

Weir Flow

$$Q = 10.5 \times d \times h^{\frac{3}{2}}$$

$$Q = 10.5 \times 2 \times 1.5^{\frac{3}{2}} = 39 \text{ cfs}$$

Orifice Flow

$$Q = 0.6 \times A \times \sqrt{2gh}$$

$$Q = 0.6 \times 3.14 \times \sqrt{2 \times 32.2 \times 1.5} = 19 \text{ cfs}$$

The lower flow rate (orifice) controls at 19 cfs. The design flow rate was 41 cfs; therefore, the proposed 24 inch riser is too small. Try a larger diameter.

Try a 36 inch diameter riser. (d=3', A=7.1 ft²)

Weir Flow

$$Q = 10.5 \times 3 \times 1.5^{\frac{3}{2}} = 58 \text{ cfs}$$

Orifice Flow

$$Q = 0.6 \times 7.1 \times \sqrt{2 \times 32.2 \times 1.5} = 42 \text{ cfs}$$

The lower flow rate (orifice) controls at 42 cfs. This is greater than the design flow. Select a 36 inch diameter riser pipe for the principal spillway.

3. **Size the Dewatering Orifice:** To dewater 36,000 cubic feet, the average discharge, Q_a , is found as follows:

$$Q_a = \frac{36,000}{6 \times 60 \times 60} = 1.7 \text{ cfs.}$$

Next, determine the average head acting on the perforations during dewatering. Assume a rectangular orifice extends from the lowest set of perforations at the wet storage elevation (103.0), up to the upper row of perforations, 3 inches below the principal spillway (105.0-0.25 = 104.75). Based upon this, the maximum head, h_p , is 2 feet (105-103) and the distance to the centroid of the orifice is 0.875 feet [(104.75-103)/2].

From Equation 7E-12.03, the average head acting on the openings is:

$$h_a = \frac{(h_p - h_c)}{2} = \frac{(2 - 0.875)}{2} = 0.56 \text{ feet}$$

Once the average head and average discharge are known, the total orifice area can be calculated from Equation 7E-12.04:

$$A = \frac{Q_a}{0.6 \times (2g \times h_a)^{1/2}} = \frac{1.7}{0.6 \times (2 \times 32.2 \times 0.56)^{1/2}} = 0.47 \text{ sf}$$

Several perforation configurations could provide this area. One feasible selection would be to provide 18, 2 1/4 inch holes in three rows (6 holes per row).

- 4. Size the Emergency Spillway:** Since this basin will have an emergency spillway, the principal spillway (riser) was only designed only to carry the 2 year storm. Larger storms, which exceed the capacity of the principal spillway, will be carried by the emergency spillway. The emergency spillway will be designed to carry the 25 year storm event.

From TR-55, using the methods described in [Chapter 2 - Stormwater](#), assume the inflow from the 25 year storm is 99 cfs.

During high flow events, both the principal spillway and the emergency spillway will be bypassing flow from the basin. From step 2, the capacity of the principal spillway is 42 cfs. Therefore, from Equation 7E-12.05, the required capacity of the emergency spillway is as follows:

$$Q_e = Q_{25} - Q_p = 99 - 42 = 57 \text{ cfs}$$

The capacity of the emergency spillway must be at least 57 cfs. From the assumptions above, the difference in elevation between the invert of the emergency spillway, and the top of the embankment is 2 feet. Since a minimum of 1 foot must be provided between the design high-water elevation and the top of the embankment, 1 foot of head is available for discharge across the spillway.

From Table 7E-12.01, find the discharge (Q) that equals or exceeds the design value of 57 cfs. From the table, for 1-foot of head, move horizontally to the discharge value of 61 cfs. Moving vertically in the table, the corresponding width for a discharge of 61 cfs is 26 feet.

5. Design Example Summary:

Basin Volume: 72,000 cubic feet (split equally between wet and dry storage)

Principal Spillway Diameter: 36 inches

Dewatering Device: 18, 2 1/4 inch holes in 3 rows (6 holes per row)

Emergency Spillway Width: 26 feet

Sediment Traps



<u>BENEFITS</u>			
	L	M	H
Flow Control	██████████		
Erosion Control	□	□	□
Sediment Control	██████████		
Runoff Reduction	██	□	□
Flow Diversion	□	□	□

Description: A sediment trap is a temporary structure that is used to detain sediment-laden runoff from small drainage areas (less than 5 acres) long enough to allow sediment to settle out. These devices are constructed by excavating a temporary pond to a pre-determined shape and volume. A stone weir or spillway most commonly controls flow from the structure.

Typical Uses: Used to remove suspended soil particles prior to releasing runoff from a construction site. Normally located at the lowest point of a construction site.

Advantages:

- One of the most useful and cost-effective measures for treating sediment-laden runoff.
- Helps control overall stormwater runoff for small storms, thus protecting streams and rivers.
- Relatively easy and cost-effective to construct.

Limitations:

- May be large and require a substantial amount of site area.
- Sediment traps may need to be eliminated prior to final stabilization on high-density sites because the occupied area is planned for development. This may make it difficult to keep the sediment trap functioning during the entire construction phase.
- Sediment traps are fairly ineffective at removing fine silts or clay particles.
- Not designed to treat runoff during intense rainfall events, which can re-suspend sediment within the trap.

Longevity: 18 months

SUDAS Specifications: Refer to [Section 9040.2.12](#) and [3.17](#)

A. Description/Uses

Sediment traps are temporary sediment control structures or ponds, having a simple outlet structure stabilized with engineering fabric and rip rap. They are typically installed in a drainage way or other point of discharge downstream from a disturbed area.

Sediment traps are one of the most reliable measures for treating sediment-laden runoff from small construction sites and may be considered the primary method of sediment removal for many sites.

Sediment traps are highly effective at treating runoff from disturbed sites up to 5 acres. For larger sites, multiple traps are recommended. For disturbed areas greater than 10 acres, a sediment basin may be required (see [Section 7E-12](#)).

B. Design Considerations

Sediment trap volumes and dimensions should be sized according to the criteria in [Section 7D-1](#). A storage volume of 3,600 cf should be provided for every acre of disturbed ground. This storage volume should be divided equally between wet storage and dry storage.

Sediment traps should be constructed at a low point, or at the point where concentrated flows leave the site. The location should be reviewed to ensure that the trap can be easily accessed for cleanout and maintenance, and that a failure of the sediment trap will not cause a loss of life or property. Sediment traps are often constructed in ditches or swales by excavating a small area to create a depression.

Construction phasing must be considered when locating sediment traps. As construction progresses, the sediment trap may need to be removed in order to complete the proposed improvements. Select a location which will allow the sediment trap to remain in service as long as possible. If construction phasing does not allow a sediment trap to remain in service until final stabilization, the trap may need to be relocated.

The outlet for a sediment trap normally consists of a stone embankment, through which the runoff flows. The embankment slows the rate and velocity of the runoff, creating a temporary pond, which allows sediment to settle out. Equations for calculating the flow through a porous medium, which would allow for exact sizing of the outlet, are available. However, these equations require that the porosity of the stone be known. In addition, an adjustment would need to be made to account for clogging of the voids over time. These criteria are difficult to determine, therefore, it is recommended that the width of the embankment be based upon the drainage area as indicated in the following table:

Table 7E-13.01: Embankment Widths for Sediment Traps

Contributing Drainage Area (acre)	Embankment Width (feet)
1	4
2	6
3	8
4	10
5	12

Source: Roberts, 1995 (FHWA)

The stone embankment should be located at the low point of the basin. The bottom of the stone embankment should equal the elevation of the top of the wet storage portion of the trap. The stone embankment serves two purposes. The porous nature of the crushed stone allows water to seep through the embankment, providing a means to dewater the dry storage volume of the trap after each rainfall event. The top of the embankment serves as an overflow spillway to control the outlet of flows during large storm events.

Construction of the stone embankment should begin by placing a layer of engineering fabric down to protect the underlying soils and help prevent them from being washed away. Next, erosion stone, or a similarly-sized material, is placed over the filter fabric to create an embankment of the height and width required.

C. Application

Sediment traps, in conjunction with other erosion control features, should be considered whenever more than 2 acres are disturbed. If more than 5 acres are disturbed, a sediment basin should be considered. If less than 2 acres are disturbed, sediment laden runoff may be controlled by other means such as silt fence or filtering products.

Sediment trap volumes and dimensions should be sized according to the criteria in [Section 7D-1](#). 3,600 cf of storage should be provided for every acre of disturbed ground. This storage volume should be divided equally between wet storage and dry storage.

D. Maintenance

Sediment traps must be cleaned out as sediment accumulates within the trap. It is recommended to clean out the trap when it has lost one-half of the wet storage volume. Upon completion of the project, the trap area should be backfilled and stabilized. Alternatively, the trap may be converted to a permanent sediment basin or detention basin.

Figure 7E-13.01: Typical Sediment Trap with a Stone Outlet
 (SUDAS Specifications Figure 9040.118)

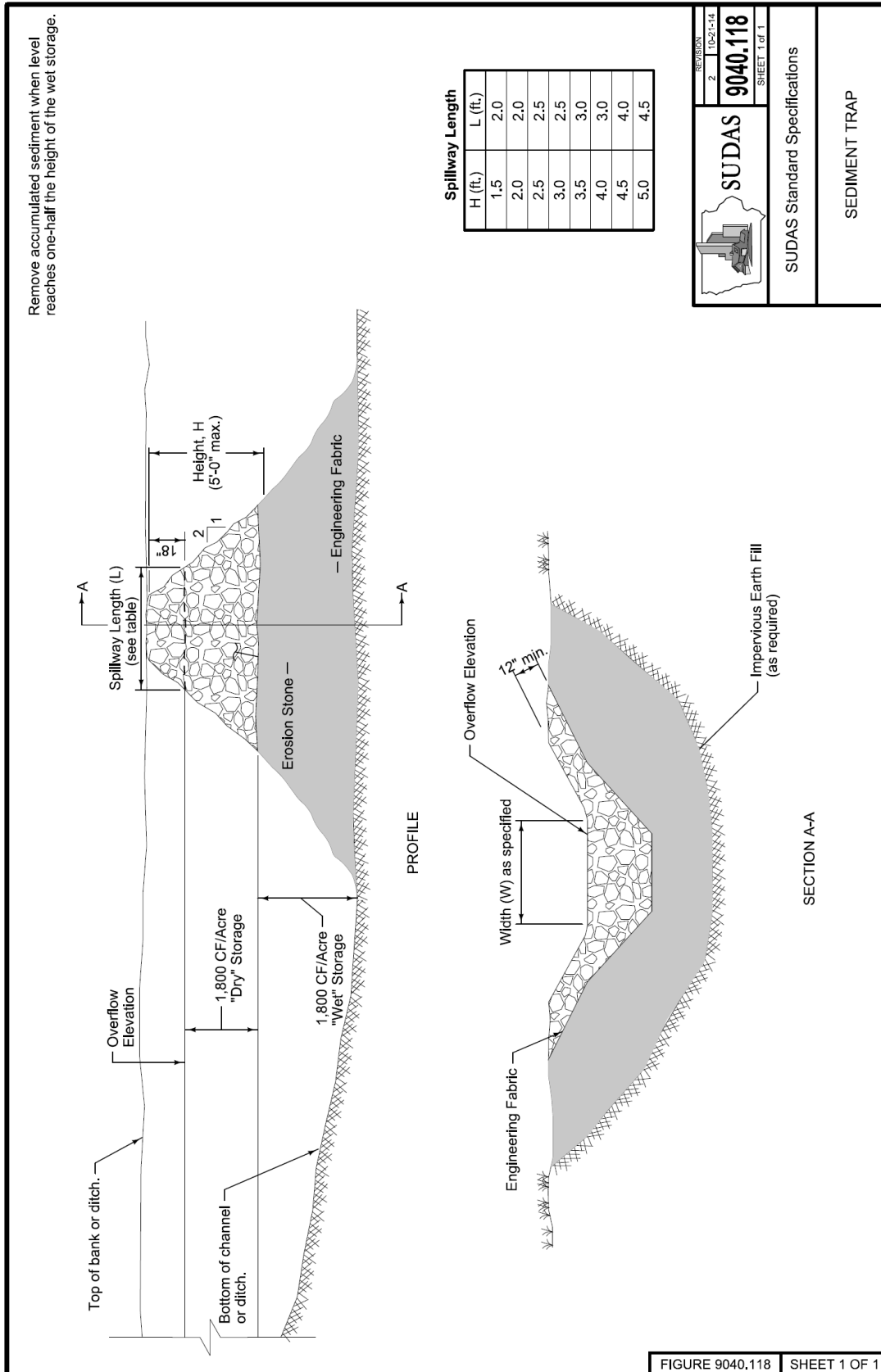

Silt Fences



<u>BENEFITS</u>			
	L	M	H
Flow Control	<input checked="" type="checkbox"/>	<input type="checkbox"/>	<input type="checkbox"/>
Erosion Control	<input type="checkbox"/>	<input type="checkbox"/>	<input type="checkbox"/>
Sediment Control	<input checked="" type="checkbox"/>	<input checked="" type="checkbox"/>	<input type="checkbox"/>
Runoff Reduction	<input type="checkbox"/>	<input type="checkbox"/>	<input type="checkbox"/>
Flow Diversion	<input checked="" type="checkbox"/>	<input type="checkbox"/>	<input type="checkbox"/>

Description: Silt fence is a temporary sediment barrier of geotextile fabric that is anchored into the ground and supported by posts on the downstream side of the fabric. Silt fences temporarily impound runoff and retain sediment onsite. They are most effective when designed to provide comprehensive water and sediment control throughout a construction site and if used in conjunction with erosion control practices.

Typical Uses: Used to control sheet flow runoff from disturbed land. May also be used to create a sediment trap for removal of suspended particles from low volume concentrated flows.

Advantages:

- Widely used BMP due to ease of installation and availability of materials.
- Relatively low cost.

Limitations:

- Ineffective against high flows.
- Must be removed after final stabilization.
- Could involve frequent maintenance related to removing accumulated silt behind the silt fence.

Longevity: Until sediment accumulates to one-half the height of the fence

SUDAS Specifications: Refer to [Section 9040, 2.13](#) and [3.18](#)

A. Description/Uses

Silt fence is a temporary barrier used to remove sediment from runoff. The fence works by intercepting sheet flow from slopes, causing the runoff to pond behind the fence, thereby promoting deposition of sediment on the uphill side of the fence.

Silt fence consists of a geotextile fabric that is trenched or sliced into the ground. The bottom of the fence is anchored into the ground by compacting the disturbed soil along both sides of the trench or slice. The top of the fence is attached to steel posts for support, creating a barrier to the flow of contaminated stormwater runoff.

Silt fence is one of the most commonly used sediment control practices. As such, it is often used improperly, or installed incorrectly. It should be placed at regular intervals on slopes to impound water. Silt fence can also be used in ditches and swales to create a small sediment containment system or ditch check. However, use as a ditch check should be limited to minor ditches and swales due to the potential for blow-out or undermining of the silt fence by high flows.

A common misconception among many designers is that the silt fence actually “filters” suspended particles from runoff. The effectiveness of silt fence is primarily derived from its ability to pond water behind the fence. This ponding action allows suspended particles to settle out on the uphill side of the fence. Particles are not removed by filtering the runoff through the fabric.

B. Design Considerations

1. Overland Flow:

- a. **General Guidelines:** Silt fence for sediment and slope control should be installed along the contour of the slope (i.e. the entire length should be at the same elevation). At each end of the silt fence a 20 foot segment should be turned uphill (“J”-hook) to prevent ponded water from flowing around the ends of the silt fence. Individual sections of silt fence should be limited to 200 foot lengths. This limits the impact if a failure occurs, and prevents large volumes of water from accumulating and flowing to one end of the installation, which may cause damage to the fence.
- b. **Sediment Control:** When used for sediment control, silt fence should be located to maximize the storage volume created behind the fence. Larger storage volumes increase the sediment removal efficiency of the silt fence, and decrease the required replacement/clean-out intervals.

A common location to place silt fence for sediment control is at the toe of a slope. When used for this application, the silt fence should be located as far away from the toe of the slope as practical to ensure that a large storage volume is available for runoff and sediment.

- c. **Slope Control:** Silt fence can be installed on a slope to reduce the effective slope length and limit the velocity of runoff flowing down the slope. Silt fence also helps prevent concentrated flows from developing, which can cause rill and gully erosion. As a secondary benefit, silt fence installed on slopes can remove suspended sediment from runoff that results from any erosion that has occurred. For slopes that receive runoff from above, a silt fence should be placed at the top of the slope to control the velocity of the flow running onto the slope, and to spread the runoff out into sheet flow.

- d. **Perimeter Control:** Silt fence is commonly used as a perimeter control along streets or adjacent to water bodies to prevent polluted water from leaving the site. When a diversion or perimeter control silt fence is installed in the direction of a slope, a 20 foot length of fence should be turned in, across the slope, at regular intervals (100 feet) to create a “J”-hook. These “J”-hooks act as check dams, controlling the velocity of the diverted runoff as it travels along the fence.
- 2. **Concentrated Flow:** For concentrated flows in swales or ditches, the silt fence is installed at right angles to the flow of water with the end posts turned uphill to prevent water from flowing around the edges. The 2 year discharge in the ditch should be checked to ensure that it does not exceed 1 cfs. For ditch or swale applications greater than 1 cfs, alternative methods of sediment removal and velocity control within the ditch, such as rock or manufactured ditch checks and sediment traps, are required.
- 3. **Diversion:** Silt fence can also be utilized as a synthetic diversion structure to redirect clean water around a site and intercept sediment-laden runoff and transport it to a sediment removal practice.

C. Application

For sediment control applications, the maximum contributing area should not exceed 1/4 acre per 100 feet of fence. If the contributing area exceeds this value, additional silt fence should be installed to break up the runoff into multiple storage areas.

When used as a velocity control measure for sheet flow on long slopes of disturbed ground, silt fence should be placed at the spacing interval stated in the table below:

Table 7E-14.01: Silt Fence Spacing on Slopes

Slope	Placement Interval (feet)
≤ 10:1 (10%)	100
5:1 (20%)	60
4:1 (25%)	50
3:1 (33%)	40

When silt fence is used under concentrated flow, as a ditch check to intercept soil and debris from water flowing through ditches or swales, the following spacing guidelines should be used:

Figure 7E-14.01: Typical Ditch Check Spacing

Ditch Grade (%)	Spacing (feet)
1 to 2	150
2 to 4	75
4 to 6	40
> 6	25

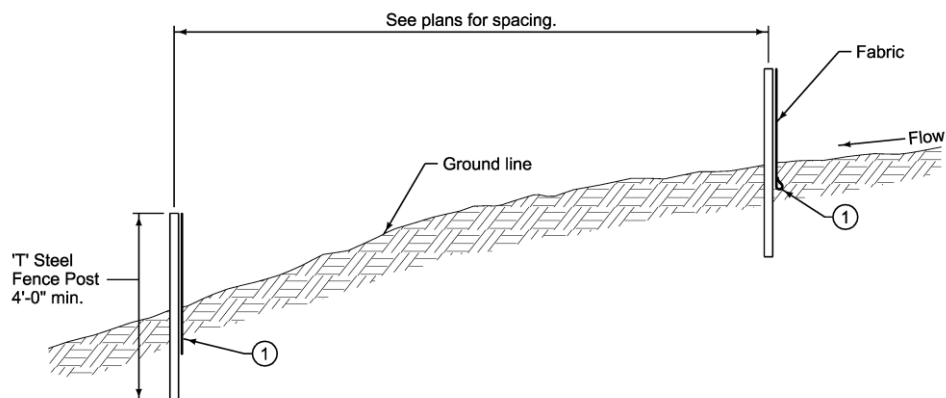

D. Maintenance

When accumulated sediment reaches approximately one-half of the fence height, new silt fence should be installed, leaving the existing fence in place, and locating the new silt fence a sufficient distance away from it to provide area for sediment accumulation. When site conditions require that the silt fence be cleaned out, rather than replaced, extreme care must be taken to ensure that the silt fence is not damaged. Removed sediment should be spread out and stabilized. Any areas of damaged silt fence should be replaced immediately.

Upon project completion, fence fabric, posts, and accumulated sediment should be removed. Any areas disturbed by the removal of the silt fence or sediment should be stabilized.

E. Time of Year

Silt fences are effective on a year-round basis. Installation may not be possible when there is frost in the ground due to the requirement to trench or slice the fence below the ground surface.

Stabilized Construction Entrance



<u>BENEFITS</u>			
	L	M	H
Flow Control	<input type="checkbox"/>	<input type="checkbox"/>	<input type="checkbox"/>
Erosion Control	<input type="checkbox"/>	<input type="checkbox"/>	<input type="checkbox"/>
Sediment Control	<input checked="" type="checkbox"/>	<input type="checkbox"/>	<input type="checkbox"/>
Runoff Reduction	<input type="checkbox"/>	<input type="checkbox"/>	<input type="checkbox"/>
Flow Diversion	<input type="checkbox"/>	<input type="checkbox"/>	<input type="checkbox"/>

Description: A stabilized construction entrance is a temporary, stabilized layer of large aggregate that is located at any point where traffic enters or leaves a construction site and enters a public road or other paved areas. Effectiveness depends on length, depth of rock, frequency of use, and maintenance of temporary rock entrance.

Typical Uses: Used where construction vehicles leave a construction site and enter onto a public street. The purpose of the rock entrance is to prevent mud from being tracked out onto the roadway, where it can cause plugging of storm sewers and fugitive dust problems.

Advantages:

- Low cost (based on stone availability) and easily installed.
- Helps prevent tracking of mud onto public streets, reducing fugitive dust and clogged storm sewers.
- Provides stable exit/entrance for construction traffic.

Limitations:

- Rock must be replaced once the voids become plugged with mud.
- May not remove all soil from vehicles, especially on muddy sites.
- Rock and sediment must be disposed of upon completion.

Longevity: Varies, based upon site conditions and volume of traffic

SUDAS Specifications: Refer to [Section 9040, 2.14](#) and [3.19](#)

A. Description/Uses

A stabilized construction entrance consists of a pad of large aggregate, often underlain with engineering fabric. Rock entrances should be located at any point where traffic will be leaving a construction site and entering a public roadway. The stabilized construction entrance reduces the amount of sediment (dust, mud, etc.) tracked offsite by construction equipment, especially if a wash-rack is incorporated for removing caked sediment.

B. Design Considerations

The entrance from a construction site is a significant source for offsite sediment deposition. Entrance and parking areas are continuously disturbed, leaving no opportunity for vegetation stabilization. During wet weather, these areas often become muddy, and construction vehicles track this mud off of the site and deposit it onto the public roadway where it clogs storm sewers and creates fugitive dust problems.

A stabilized construction entrance can reduce the amount of sediment that is tracked into the street by construction traffic. A rock entrance stabilizes the access to the site, and helps remove mud and clay from vehicle tires before they leave the site. A stabilized construction entrance should be constructed on every construction site, prior to the mobilization of construction equipment.

- 1. Location:** A stabilized construction entrance should be located at every point where construction traffic leaves a construction site. Vehicles leaving the site should travel over the entire length of the rock entrance. When possible, the entrance should be located on level ground, at a location with appropriate sight distance. Construction vehicles should be prohibited from leaving the site at locations other than the stabilized construction entrance. Fence should be constructed if necessary. If additional access to the site is required, additional rock entrances should be constructed
- 2. Site Preparation:** The area of the entrance should be excavated to the proposed thickness of the stone, stripping any topsoil, vegetation, and soft soils as necessary to provide a stable subgrade. When soft soil conditions exist, or when earthmoving or other heavy equipment will use the entrance, a subgrade stabilization fabric should be placed over the entire length and width of the entrance prior to placing the rock.
- 3. Drainage:** Slopes should not exceed 15% and should be carefully graded to drain transversely to prevent runoff from the entrance from flowing into the street. All surface water flowing off of the construction entrance should be directed to a sediment removal device (sediment basin or trap, silt fence, filter sock, etc.).
- 4. Tire Washing or “Wash-rack”:** A properly constructed rock entrance should not be relied upon to remove all the mud from construction traffic. In some cases, the action of tires moving over a gravel pad may not adequately clean tires. If conditions on the site are such that the majority of the mud is not removed by the vehicles traveling over the rock, then the tires of the vehicles should be washed before entering the public road. Manual washing of the tires should be provided, or automated wash racks should be installed. Wash water must be carried away from the entrance to a sediment removal device (sediment basin or trap, silt fence, filter tube, etc.). All sediment shall be prevented from entering storm drains, ditches, or watercourses.

C. Application

1. **Length:** Minimum of 50 feet with an exception for single family residential lots which should be 30 feet. For sites that will be utilizing the entrance to haul a large volume of earth, the length of the entrance should be increased.
2. **Width:** Minimum of 20 feet wide. Busy entrances will need the capability of handling a lane of traffic each way, typically 30 feet wide. Flare the entrance where it meets the existing road to provide a turning radius.
3. **Geotextile:** If soft soil conditions exist, or when earthmoving or other heavy equipment will utilize the entrance, a layer of subgrade stabilization fabric should be placed over the prepared subgrade prior to placement of the rock to minimize migration of stone into the underlying soil by heavy vehicle loads. The barrier created by the fabric also aids in removal of the stone upon completion of the project, or as required for maintenance.
4. **Stone:** The rock for the entrance should consist of a nominal 2 to 3 inch clean crushed stone or recycled concrete. A 6 to 12-inch thick layer of stone, depending on anticipated traffic, should be placed over the entire length and width of the construction entrance. Rock with smaller aggregate does not adequately remove mud and clay from vehicles, and may be picked up by vehicle tires and carried out into the street.

D. Maintenance

Construction entrances should be inspected daily to ensure that mud and dirt are not being tracked onto roadways. All sediment deposited on paved roadways should be removed, not washed into the stormwater system or into waterways, at the end of each workday.

Rock entrances may require that additional stone be placed if the existing material becomes buried or if the subgrade is soft or becomes saturated.

Upon completion of the project the rock entrance, engineering fabric and any accumulated sediment should be removed and disposed.

Dust Control



Source: Jerico Services, Inc.

<u>BENEFITS</u>			
	L	M	H
Flow Control	<input type="checkbox"/>	<input type="checkbox"/>	<input type="checkbox"/>
Erosion Control	<input checked="" type="checkbox"/>	<input type="checkbox"/>	<input type="checkbox"/>
Sediment Control	<input type="checkbox"/>	<input type="checkbox"/>	<input type="checkbox"/>
Runoff Reduction	<input type="checkbox"/>	<input type="checkbox"/>	<input type="checkbox"/>
Flow Diversion	<input type="checkbox"/>	<input type="checkbox"/>	<input type="checkbox"/>

Description: Dust control is the practice of controlling fugitive dust that results from grading, demolition, hauling, and traffic on construction sites. Fugitive dust may cause offsite damage, health hazards, and traffic problems if preventive measures are not taken.

Typical Uses: Used in open, windy areas such as the tops of hills and on construction sites with exposed soil in open areas. Also used in locations where construction traffic is high, such as the entrance to the site. Dust control may also be applied to soil stockpiles.

Advantages:

- Low visibility conditions caused by airborne dust are minimized.
- Dust control methods are widely applicable.
- Most dust control methods are inexpensive and promote the growth of stabilizing vegetation.
- Most dust control methods are easy to install/apply and maintain.

Limitations:

- Some temporary dust controls must be reapplied or replenished on a regular basis.
- Some controls are expensive (e.g., chemical treatment), may be ineffective under certain conditions, or have their own associated impacts.
- If chemical dust control treatment is over-applied, excess chemicals could potentially cause both surface and groundwater contamination.
- Petroleum products should not be used for dust control as there is potential for stormwater pollution and groundwater contamination.

Longevity: Usually short term; actual time varies by method and weather conditions

SUDAS Specifications: Refer to [Section 9040, 2.15](#) and [3.20](#)

A. Description/Uses

Earth-moving activities comprise the major source of construction dust emissions, but traffic and general disturbance of the soil also generate significant dust emissions. Therefore, dust control should be used when open dry areas of soil are anticipated on the site.

Dust control measures include minimization of soil disturbance, spray-on adhesives, tillage, chemical treatment and water spraying, and ensuring trucks are tarped upon leaving the construction site. In many cases, measures incorporated into the project to prevent soil erosion by water will indirectly prevent wind erosion.

While there are a number of temporary alternatives for dust control, one option is to permanently modify the site to eliminate dust generation. Modifications could include measures such as covering exposed areas with vegetation, mulch, stone or concrete. For the purpose of this standard, the focus is on temporary dust control measures.

B. Design Considerations

While several different products and practices are available for dust prevention, the most important tool is proper planning. During the design phase, the site should be analyzed for potential dust problems and the work coordinated to minimize dust problems.

The first step is to identify construction entrances and haul roads and provide a stable surface by paving, providing rock, or by chemical stabilization. Construction traffic on unstabilized haul roads should be limited as much as possible. When necessary, construction traffic on unstabilized ground should be limited to low speed operations (15 mph or less).

Existing vegetation or crop residue should be left in place as long as possible. When possible, existing tree lines should be left in place to act as a windbreak.

When dust problems are anticipated or are occurring during construction, there are a number of methods and products available to temporarily stabilize the surface and suppress the dust. Selection of these products or practices depends on several factors, including soil type, climate, and the necessary duration of treatment.

- 1. Watering:** Spraying the surface of the ground with water is a readily available and highly effective method of suppressing dust, though very a short term one. Water trucks can provide onsite control of fugitive dust on haul roads and disturbed surfaces on an as-needed basis. The frequency of watering depends on several factors, including weather, soil type, and construction traffic. Water treatment is typically only effective for one-half hour to 12 hours. Water should be applied at a rate so that the soil surface is wet, but not saturated or muddy. If watering is to be employed at a construction site, it should be used in conjunction with a temporary gravel rock entrance, created to prevent mud from being spread on local streets.
- 2. Tillage:** (See [Section 7E-19 - Surface Roughening](#)). Large, open, disturbed areas should be deep plowed to bring dirt clods to the surface. As the wind blows across smooth disturbed ground, the entire surface is exposed to the wind, creating a high potential for suspending dust particles. When the surface is roughened, only the peaks of the surface are exposed to the wind. In addition, the clods lying on top of the ground help stabilize the surface. This is a temporary emergency measure that can be used as soon as dust generation starts. Plowing should begin on the windward side of the site and leave 6-inch furrows, preferably perpendicular to the prevailing wind direction, to gain the greatest reduction in wind erosion. Tillage is only applicable to flat areas.

- 3. Soil Stabilizers and Dust Suppressants:** These are chemicals applied on or mixed into the soil surface that maintain the moisture levels in exposed soils, or chemically bind the surface material to reduce fugitive dust emissions from the site. These products include:
- a. Calcium Chloride:** Maintains water levels in the surface layer by absorbing humidity out of the air. May be applied by mechanical spreader as loose, dry granules or flakes, or as a liquid solution. Generally requires one or two treatments per season. Calcium chloride treated soils can inhibit the growth of vegetation and runoff from these areas can pollute water bodies. Therefore, calcium chloride should not be applied to large areas for site-wide dust control. When used, calcium chloride applications should be restricted to haul roads, and small areas.
 - b. Lignosulfonate:** Derived from wood pulp, lignosulfonate is a byproduct of the paper industry and is often referred to as “tree sap.” It is applied as a liquid to the ground surface, and binds the surface particles together. Generally requires one or two treatments per season.
 - c. Soybean Oil (Soapstock):** Acidulated soybean oil soapstock is a by-product of the refining process of soybean oil. It is applied as an undiluted liquid to the ground surface and binds the surface particles together. Proper storage and transportation of soybean oil require that the material be kept at a constant temperature of 155 degrees Fahrenheit and continuously agitated. Application of the material may require special pumping equipment. These restrictions may limit the use of soybean oil for dust control. Generally requires one treatment per season.
- 4. Track-out Control:** (See [Section 7E-15 - Stabilized Construction Entrance](#)). Soil tracked out onto streets by construction vehicles eventually dries and creates a fugitive dust. A stabilized construction entrance should be provided to aid in removing soil from vehicles before they enter the roadway.

C. Application

Apply chemical controls at the manufacturer's specified rates and according to all federal, state, and local regulations governing their use. If a chemical dust control treatment is over-applied, excess chemicals could potentially cause both surface and groundwater contamination. Recommended application rates are listed in the table below. Chemical products must be stored, handled, and disposed of according to all applicable local, state, and federal regulations.

Table 7E-16.01: Recommended Application Rates for Dust Suppression Products

Product	Mixture	Application Rate ¹
Calcium chloride	Dry flake or liquid solution	1 lb/SY on anhydrous basis
Lignosulfonate	Diluted with water to 25% solids	1 gal/SY
Soybean oil (soapstock)	Undiluted	0.70 gal/SY

¹Application rates are approximate and may need to be adjusted based upon site conditions

Source: Bolander, 1999 and Morgan, 2005

D. Maintenance

All dust control methods are temporary and require periodic maintenance. Wetting the ground surface with water may be necessary several times a day during hot and dry weather. Other methods provide longer effectiveness, and may only need to be applied once or twice per year.

Erosion Control Mulching



<u>BENEFITS</u>			
	L	M	H
Flow Control	<input checked="" type="checkbox"/>	<input type="checkbox"/>	<input type="checkbox"/>
Erosion Control	<input checked="" type="checkbox"/>	<input checked="" type="checkbox"/>	<input type="checkbox"/>
Sediment Control	<input checked="" type="checkbox"/>	<input type="checkbox"/>	<input type="checkbox"/>
Runoff Reduction	<input checked="" type="checkbox"/>	<input type="checkbox"/>	<input type="checkbox"/>
Flow Diversion	<input type="checkbox"/>	<input type="checkbox"/>	<input type="checkbox"/>

Description: Mulching is the application of organic material over soil that is bare or immediately over soil that has been seeded. Mulch prevents erosion by preventing the detachment of soil particles, slows runoff velocity, and retains moisture to improve germination and establishment of vegetative cover.

Typical Uses: This practice may be applied on exposed soils as a temporary control where soil grading or landscaping has taken place or in conjunction with temporary or permanent seeding. When time constraints prevent the establishment of vegetation (seeding), mulch such as wood chips, straw, or compost can be used independently as a temporary soil stabilization practice that protects the soil surface until vegetation establishment can be completed.

Advantages:

- Provides immediate surface protection.
- Suppresses weed growth.
- Conserves soil moisture.
- Acts as a thermal layer for seed.
- If used in conjunction with seed, allows seed growth through the mulch.
- Useful for dust control.

Limitations:

- If applied too thick, it may inhibit seed germination.
- Can blow or wash away if not anchored properly.

Longevity: Varies by material (three months to one year)

SUDAS Specifications: Refer to [Section 9040, 2.16](#) and [3.21](#)

A. Description/Uses

Used alone or applied over seed, mulch provides immediate erosion protection. Mulching without seeding may be considered for very short-term protection. Mulch protects the disturbed soil surface by absorbing the impact of raindrops, thereby preventing detachment of the soil particles. It also retains and absorbs water, slowing runoff. These properties allow for greater infiltration of water into soil; help to retain seeds, fertilizer and lime in place; and improve soil moisture and temperature conditions for seed germination. Mulch is essential in establishing good stands of grasses and legumes. In order to prevent movement by wind or water, it is important that the mulch be anchored to the soil.

B. Design Considerations

The plans and specifications should address the type of mulch used, application rate, timing of the application, method of anchoring, and schedule for installation, inspection, and maintenance.

1. **Site Preparation:** The soil surface shall be prepared prior to the application of mulch in order to achieve the desired purpose and to ensure optimum contact between soil and mulch.
2. **Material Considerations:**
 - a. **General:**
 - 1) Mulching should not be performed during periods of excessively high winds that would preclude the proper placement of mulch.
 - 2) Concentrated flows should be diverted around areas where mulch is applied.
 - 3) If ground is seeded, mulching should be completed during or immediately after seeding.
 - 4) Depending on the seeding period, a heavier application of mulch may be needed to prevent seedlings from being damaged by frost.
 - 5) In areas where lawn-type turf will be established, the use of tackifiers is the preferred anchoring method. Crimping tends to leave an uneven surface and netting can become displaced and entangled in mowing equipment.
 - 6) The use of mulch behind curb and gutter may not be desirable unless anchored by netting, because air turbulence from nearby traffic can displace mulch. Consider the use of erosion mat or sod as an alternative.
 - 7) The product longevity should match the length of time the soil will remain bare or until vegetation occurs.
 - b. **Straw:**
 - 1) Straw mulch should be applied in conjunction with temporary or permanent seeding, except when applied for short-term (less than three months) stabilization prior to the allowable seeding date.
 - 2) To prevent straw from being wind blown, it is anchored to the soil surface using tackifiers, nets, or a mulch-crimping machine. Mechanical anchoring or crimping is recommended only for slopes flatter than 2:1. Mulch on slopes steeper than 2:1 should be anchored to the soil with netting, or other alternatives, such as a rolled erosion control product considered.
 - 3) Only use straw free from all noxious weeds, seed bearing stalks, or roots
 - 4) Expected longevity is less than three months.

- c. Wood Chips/Grindings:**
- 1) Do not use wood chips/grindings over newly seeded areas.
 - 2) Chips may be produced from vegetation removed from site.
 - 3) Chips are effective on slopes up to 3:1.
 - 4) Wood chips decompose over an extended period of time. This process may take nitrogen from the soil. To prevent nitrogen deficiency in the soil, the wood mulch should be treated with a nitrogen rich fertilizer.
 - 5) Do not use in areas where fine turf will be established.
 - 6) Expected longevity is less than 12 months.
- d. Hydromulch:** Hydromulching is normally conducted in conjunction with hydroseeding, but can also be applied as a stand-alone practice. Several different types of hydromulch are available, and each has different material properties and typical uses:
- 1) Wood Cellulose Fiber Hydromulch:**
 - a) Produced from wood pulp and recycled paper
 - b) Most commonly used hydromulch
 - c) Use is limited to slopes 6:1 or flatter.
 - d) Typically require 24 hours to dry before rainfall occurs in order to be effective against erosion.
 - e) Expected longevity is 3 to 12 months.
 - 2) Bonded Fiber Matrix (BFM) Hydromulch:**
 - a) Produced from strands of elongated wood fibers and a binding agent
 - b) May be used on slopes up to and including 2:1.
 - c) Typically requires 24 hours to dry before rainfall occurs in order to be effective against erosion.
 - d) Expected longevity is 3 to 12 months.
 - e) Provides significantly superior erosion protection than straw mulch or wood cellulose hydromulch.
 - 3) Mechanically Bonded Fiber Matrix (MBFM) Hydromulch:**
 - a) Produced from strands of elongated wood fibers and crimped synthetic fibers to create an interlocking mechanism between the fibers. Material is combined with additional binding agents.
 - b) May be used on slopes up to and including 2:1.
 - c) Provides immediate protections against erosion. No cure time is required to develop surface protection.
 - d) Expected longevity is 12 months or greater.
 - e) Provides significantly superior erosion protection than straw mulch or wood cellulose hydromulch.
- e. Compost:**
- 1) Compost may be used as mulch, either with or without seeding for erosion protection. See [Section 7E-2 - Compost Blanket](#).
 - 2) Expected longevity is less than 12 months.

C. Application

- 1. Mulching without Seeding:** Wood mulch and compost applied without seed, should be applied to a uniform depth of 1 to 3 inches depending on slope. Straw mulch should be applied at a rate of 2 tons per acre to achieve the specified coverage rate. Wood cellulose fiber hydromulch should be applied at a rate of 2,600 pounds per acre. BFM and MBFM hydromulch should be applied at a rate of 3,600 pounds per acre.

2. **Mulching for Seeding:** Straw mulch over newly seeded areas should be applied at a rate of 1 1/2 tons per acre. This application provides some protection of the surface, while allowing some sunlight to penetrate and air to circulate thereby promoting seed germination. When compost is used as mulch over newly seeded areas, a minimum thickness of 1 inch should be spread evenly over flat surfaces. For compost used as mulch on slopes, see compost blankets in [Section 7E-2](#). Hydromulch products applied with seeding (hydroseeding) are applied at the same rate as without seeding (see paragraph above).

The NPDES General Permit No. 2 requires that all disturbed areas where no construction activities are scheduled for a period of 21 calendar days or more, be stabilized within 14 days of the final construction activity. Mulching is one way to meet this requirement.

D. Maintenance

Inspect mulched areas for signs of thin or bare spots. Add mulch as required to maintain the thickness of the cover. Areas that show signs of erosion should be repaired, and may require additional protection with an erosion control blanket or other method.

E. Time of Year

Mulch applications for establishing vegetation should be done when weather and soil conditions are favorable. Mulch can be applied over bare frozen ground that has not been seeded to help prevent erosion until such time as vegetation can be established.

Turf Reinforcement Mats (TRM)



<u>BENEFITS</u>			
	L	M	H
Flow Control	■	□	□
Erosion Control	■	■	■
Sediment Control	□	□	□
Runoff Reduction	□	□	□
Flow Diversion	□	□	□

Description: Turf reinforcement mats (TRMs) are composed of non-degradable synthetic fibers, filaments, nets, wire meshes, and/or other elements, processed into a permanent, three dimensional matrix. TRMs are designed to impart immediate erosion protection, enhance vegetation establishment, and permanently reinforce vegetation during and after maturation.

Typical Uses: TRMs are typically used on steep slopes and in hydraulic applications such as high flow ditches and channels, stream banks, shorelines, and inlet/outlet structures. TRMs are used where erosive forces may exceed the limits of natural, unreinforced, vegetation, or in areas where limited vegetation establishment is anticipated.

Advantages:

- Can withstand high hydraulic shear stresses and velocities.
- Provides permanent, long-term reinforcement of vegetation. Does not degrade over time like RECPs.
- Ability to be vegetated creates a more aesthetically pleasing appearance than rip rap, concrete, or other “hard armor” techniques.
- Can stabilize ground where vegetation is difficult to establish.
- Normally a less expensive alternative to “hard armor” techniques.

Limitations:

- Performance is dependent upon proper product selection and installation
- Can only withstand a limited amount of flow before hard armoring is required.

Longevity: Permanent

SUDAS Specifications: Refer to [Section 9040.2.17](#) and [3.22](#)

A. Description/Uses

Turf reinforcement mats (TRMs) are a three dimensional product, constructed of synthetic, non-degradable (though some products are a composite of degradable and non-degradable materials) materials. The non-degradable matting creates a permanent reinforcing system for vegetation. The resulting reinforced vegetation is able to withstand significantly greater erosive forces than normal vegetation.

Traditionally, hard-armor erosion control techniques, such as rip rap and reinforced paving systems, have been employed to prevent soil erosion in highly erosive areas. Although these permanent measures can withstand substantial hydraulic forces, they are costly, and they do not provide the pollutant removal capabilities of vegetated systems.

TRMs enhance the natural ability of vegetation to permanently protect soil from erosion. In addition to providing scour protection, TRMs are designed to encourage vegetative root and stem development. By protecting the soil from scouring forces and enhancing vegetative growth, TRMs can raise the threshold of natural vegetation to withstand higher hydraulic forces on slopes, in streambanks and channels, and at inlet/outlet structures.

TRMs, unlike temporary erosion control products, are designed to remain in place permanently to protect seeds and soils, improve germination, and reinforce established vegetation. Some TRMs incorporate natural, degradable fiber material to assist in the initial establishment of vegetation; however, the permanent reinforcement structure of TRMs is composed entirely of non-degradable materials.

In addition to providing permanent reinforcement of vegetation, TRMs also protect disturbed surfaces immediately after installation (prior to establishment of vegetation). This benefit is important for preventing soil loss and protecting newly seeded areas.

B. Design Considerations

TRMs are produced by a number of manufacturers, and are available in a wide variety of configurations. The following steps should be considered when designing and specifying an appropriate TRM.

- 1. Hydraulic Stresses:** TRMs in channels should be designed based upon the calculated shear stress. The shear stress imposed on the TRM in the channel should be evaluated under two conditions: temporary (unvegetated) and permanent (vegetated). The temporary condition represents the unvegetated conditions immediately after installation of the TRM. The permanent condition represents the long-term protection provided by the TRM in its fully vegetated state.

A TRM in a permanent vegetated state should be designed to withstand a 10 year storm event. In a fully vegetated channel, the TRM is located well below the top of the exposed vegetation. As a result, it has little impact on the level of shear created by the flow and its presence can be ignored. In doing this, the shear stress in the fully vegetated channel is determined in the same manner as described in [Section 7E-23 - Grass Channel](#).

The TRM should also be analyzed for an unvegetated state. Since this condition is temporary, the unvegetated TRM can be evaluated for a 2 year storm (rather than the 10 year). This analysis also follows the method described in [Section 7E-23 - Grass Channel](#), but since there is no vegetation, the Manning coefficient is constant. The Manning coefficient of a TRM is normally provided in the manufacturer's literature.

Many TRM manufacturers have software available to aid in the calculation of shear stress. This software may be available through the manufacturer's website or local product representative.

Once the anticipated shear stresses are known, a TRM can be selected. Most TRM manufacturers report the permissible shear stresses that their products can withstand in both the vegetated and unvegetated conditions. These values are typically determined from full-scale, third party hydraulic flume testing. Commonly accepted facilities for conducting these tests include the Texas Transportation Institute (TTI), Colorado State University, and Utah State University. The designer should select a product with a greater permissible shear stress than the actual calculated hydraulic shear stress of the system. Note: for TRMs containing degradable components, the reported permissible values must represent only the permanent, synthetic portions of the TRM to satisfy the long-term design and performance requirements.

- 2. Non-hydraulic Stresses:** In addition to the hydraulic stress (shear), consideration must also be given to non-hydraulic stresses. Examples of non-hydraulic stresses include heavy mowing equipment, occasional vehicular traffic, and heavy debris in the channel, or on a slope.

The materials that most TRMs are constructed from are not intended to withstand these non-hydraulic stresses. This type of loading can cause the material to tear, creating the potential for failure of the entire system.

For installations that will be exposed to these types of stresses, a high tensile strength material should be specified. These high tensile strength materials are commonly called high survivability or high performance TRMs. These high strength TRMs will provide long-term structural integrity, even when exposed to potentially damaging non-hydraulic stresses.

Table 7E-18.01: TRM Material Requirements and Acceptable Applications

	Property ¹	Test Method	Type 1	Type 2	Type 3	Type 4
Material	Thickness	ASTM D 6525	0.25 in	0.25 in	0.25 in	0.25 in
	Tensile Strength ²	ASTM D 6818	125 lb/ft	240 lb/ft	750 lb/ft	3,000
	UV Resistance ³	ASTM D 4355	80% @ 500 hrs	80% @ 1,000 hrs	80% @ 1,000 hrs	90% @ 3,000 hrs
Performance	Maximum Shear Stress ⁴ (Channel Applications)	ASTM D 6460	7 lb/ft ²	10 lb/ft ²	12 lb/ft ²	15 lb/ft ²
	Maximum Slope Gradient (Slope Applications)	N/A	1:1 (H:V) or flatter	1:1 (H:V) or flatter	1:1 (H:V) or greater	1:1 (H:V) or greater

¹ For TRMs containing degradable components, all values must be obtained on the non-degradable portion of the matting.

² Minimum Average Roll Values, machine direction only.

³ Tensile strength of structural components retained after UV exposure.

⁴ Minimum shear stress that fully-vegetated TRM can sustain without physical damage or excess erosion (0.5 in soil loss) during a 30 minute flow event in large scale testing. Acceptable large scale testing protocol includes ASTM D 6460 or independent testing conducted by the Texas Transportation Institute, Colorado State University, Utah State University, or other approved testing facility. Bench scale testing is not acceptable.

C. Application

Turf reinforcement mats should be selected and used in locations where vegetation alone cannot withstand the anticipated flow velocities and shear stresses, and where hard armor (concrete and rip rap) is not necessary or is visually unappealing, or where stormwater quality and sediment/pollutant removal is desirable.

D. Maintenance

Once installed, there is little maintenance that needs to be done to TRMs. If the TRM is to be vegetated, the vegetation should be watered as needed (refer to [Section 7E-24 - Permanent Seeding](#)). Until the vegetation is fully established, the ground surface should be inspected for signs of rill or gully erosion below the matting. Any signs of erosion, tearing of the matting, or areas where the matting is no longer anchored firmly to the ground should be repaired.

E. Design Example

Assume a channel with a 4 foot bottom, 3:1 side slopes, and a slope of 3% is designed to carry 265 cfs. Lining the channel with a TRM is being proposed. Determine if a selected vegetated TRM, with Class C vegetation is adequate. Also analyze the TRM for the unvegetated condition to ensure that it will provide sufficient protection until vegetation is established. The manufacturer of the TRMs provided the following information on the TRM's properties:

Permissible shear stress, vegetated - 8 lbs/ft²
 Permissible shear stress, unvegetated - 4.55 lbs/ft²
 Manning's n Coefficient - 0.026

Solution:

First determine the shear stress for the vegetated condition. Using Manning's equation, find the depth of flow. This can be done through a trial and error process, or by using various tables and charts.

Trial 1 - Assume a depth of 2 feet.

$$\text{Area of Flow, } A = (b + Z \times d) \times d = (4 + 3 \times 2) \times 2 = 20 \text{ ft}^2$$

$$\text{Wetted Perimeter, } P = b + 2 \times \sqrt{d^2 + (Zd)^2} = 4 + 2 \times \sqrt{2^2 + (2 \times 3)^2} = 16.6 \text{ ft}$$

$$\text{Hydraulic Radius, } R = A/P = 20/16.6 = 1.2$$

Manning coefficient (from [Equation 7E-23.01, Section 7E-23 - Grass Channel](#)):

$$n = \frac{0.1.2^{1/6}}{19.97(\log(44.8 \times 0.66^{0.6} \times 1.2^{-0.4}) + \log(0.1.2^{1.4} \times .03^{0.4}))} = 0.051$$

$$\text{Solving Manning's yields: } Q = 1.49 / n \times A R^{2/3} S^{1/2} = (1.49 / 0.051)(20)(1.2)^{2/3}(0.03)^{1/2} = 114 \text{ cfs}$$

Since 114 cfs is less than the design value of 265 cfs, a larger depth should be assumed.

Trial 2 - Assume a depth of 3 feet.

Following the procedure for Trial 1 – A = 39; P=23; R=1.7; n=0.045; Q= 318 cfs. Q is too large.

Trial 3 - Assume a depth of 2.8 feet

A=34.7; P=21.7; R=1.6; n=.046; Q=266 – Say 265 cfs OK.

Now that the depth is known for the vegetated condition, the shear stress can be determined by [Equation 7E-23.02 from Section 7E-23 - Grass Channel](#).

$$\tau_{\max} = \gamma \times d \times S = 62.4 \times 2.8 \times 0.03 = 5.2 \text{ lbs/ft}^2$$

Since the maximum shear stress of 5.2 lbs/ft² is less than the capacity of the vegetated TRM (8.0 lbs/ft²), the design is acceptable.

Now analyze for the unvegetated condition to ensure that an adequate level of protection will be provided until the vegetation is established.

Following the same procedure as the previous example, the channel properties are calculated. Note that for the unvegetated condition, a constant Manning coefficient (in this case 0.026) can be assumed.

Assuming a depth of 2.1

A=21.6; P=17.3; R=1.25; Q=249. Q is too low. Select a larger depth.

Assuming a depth of 2.16

A=22.6; P=17.7; R=1.28; Q=265. Assume 266 cfs. OK

Calculate Shear stress on the unlined channel.

$$\tau_{\max} = \gamma \times d \times S = 62.4 \times 2.16 \times 0.03 = 4.04 \text{ lbs/ft}^2$$

Since the maximum shear stress of 4.04 lbs/ft² is less than the capacity of the unvegetated TRM (4.55 lbs/ft²), the design is acceptable.

Surface Roughening



Source: Clackamas County, 2000

<u>BENEFITS</u>			
	L	M	H
Flow Control	■	□	□
Erosion Control	■	□	□
Sediment Control	□	□	□
Runoff Reduction	■	□	□
Flow Diversion	□	□	□

Description: Surface roughening is a temporary practice incorporated during grading, that reduces soil loss by reducing the flow velocity of runoff. Surface roughening may also be used as a method of reducing dust (See [Section 7E-16 - Dust Control](#)).

Typical Uses: For slopes where additional grading is anticipated prior to permanent/temporary stabilization. To reduce runoff velocity, trap sediment, increase infiltration, and aid in the establishment of vegetative cover. Typically performed as an end-of-day practice.

Advantages:

- Simple and cost-effective.
- Immediate, short-term control.
- Reduces both wind and water erosion.

Limitations:

- Could increase soil compaction, requiring additional seedbed preparation.
- Not a stand-alone practice - it must be used in conjunction with other erosion and sediment control measures.

Longevity: Short-term, depends on precipitation

SUDAS Specifications: Refer to [Section 9040, 3.23](#)

A. Description/Uses

Disturbed, non-vegetated areas that are graded smooth and have compacted soil cause increased runoff and reduce the ability of vegetation to be re-established, resulting in erosion. Surface roughening abrades the soil surface with horizontal ridges and depressions across the disturbed area. The use of this practice helps lessen erosion and sediment transport during grading operations.

B. Design Considerations

Surface roughening is not a stand-alone measure, and should always be used in conjunction with other erosion and sediment control practices. Surface roughening may be applied after grading activities cease (temporarily), but will be resumed again within 21 days. Surface roughening might also be employed on an actively graded slope, prior to an impending storm, to provide some level of erosion protection.

Roughening methods include creating furrows across the slopes and tracking up and down the slope. The type of roughening depends on the steepness of the slope and the soil type.

- 1. Directional Tracking:** Tracking uses the depressions formed by the tracks from bulldozers and other construction vehicles. The vehicle is driven up and down the slope, leaving behind horizontal depressions in the soil. These depressions interrupt the runoff's flow, reducing its velocity and erosive capacity.

Directional tracking is the least effective, but likely most convenient, method of surface roughening. Directional tracking should only be performed on slopes that are 3:1 or flatter, as its use on steeper slopes may not prevent concentrated flow from developing. For slopes steeper than 3:1, grooving/furrowing should be used (see information below).

Directional tracking is ideally suited for sandy soils, as they do not compact as severely. Its use on clay-based soils should be limited, unless no other alternatives are available. As few passes of the machinery should be made as possible in order to limit compaction.

It is imperative that the equipment track perpendicular to the contour, creating groves that are parallel to the contour. Tracking along the contour will create vertical grooves and ridges for the runoff to follow, actually increasing the erosion potential.

- 2. Grooving:** Grooving is a method of surface roughening that creates a series of ridges and depressions along the contour of the slope. Grooving may be accomplished with rippers, disks, spring harrows, chisel plows, or any equipment capable of operating safely on the slope. The grooves created should be no more than 15 inches apart and should not measure less than three inches in depth. Grooving is more effective erosion control practice than vehicle tracking and may be used with all soils types and all slopes.

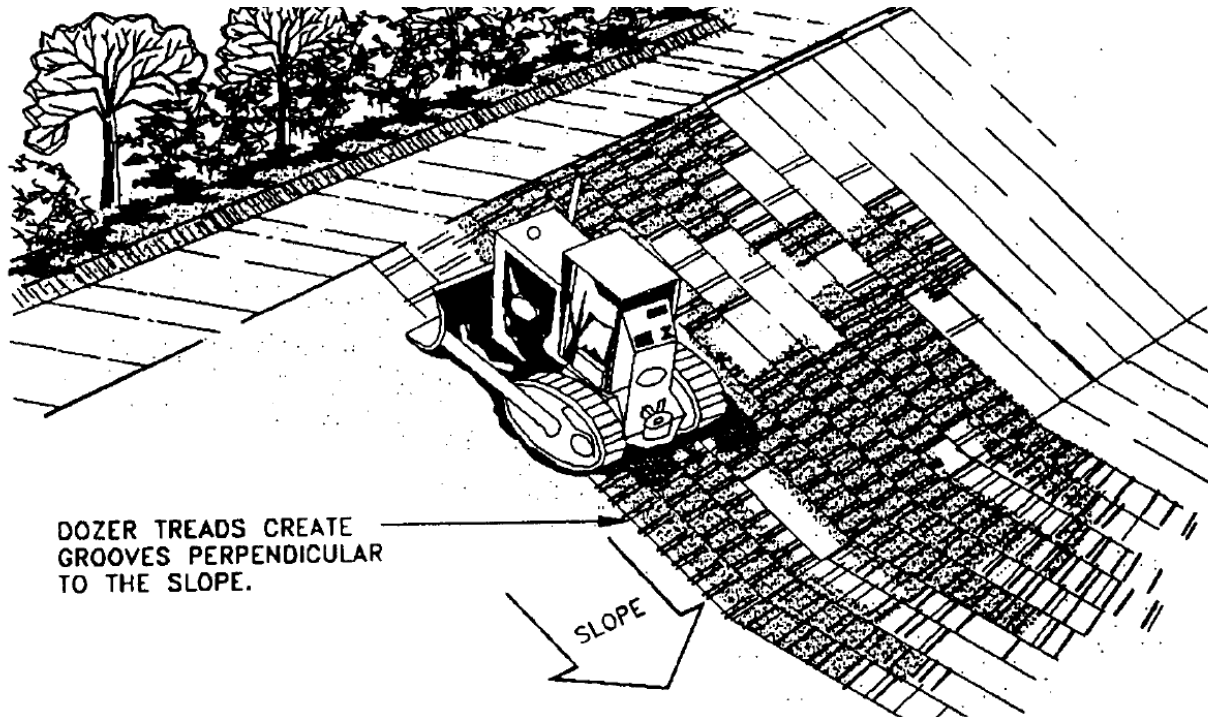
Figure 7E-19.01: Typical Directional Tracking on a Bare Slope

Source: US Army Corps of Engineers, 1997

Regardless of the method used, after the disturbed area has been roughened it should be protected from vehicular traffic as it may greatly reduce the efficiency of the roughening and require the practice to be repeated. At no time should slopes be bladed or scraped to produce a smooth, hard surface.

C. Application

Surface roughening is a simple method of providing at least a minimal level of short-term erosion protection for slopes which are still under construction, but on which work is being halted for a short period of time. Surface roughening should be provided on all slopes at the end of the workday. It can also be done, in conjunction with mulching, after the fall seeding period has passed to stabilize a site and carry it through the winter months.

D. Maintenance

Surface roughening is a short-term practice that needs to be reapplied whenever the roughened surface is removed by re-grading or weather conditions. Typically, surface roughening on a slope will need to be reestablished after each rain event, regardless of intensity.

Inlet Protection



Source: Soil Tek

BENEFITS

	L	M	H
Flow Control	<input type="checkbox"/>	<input type="checkbox"/>	<input type="checkbox"/>
Erosion Control	<input type="checkbox"/>	<input type="checkbox"/>	<input type="checkbox"/>
Sediment Control	<input checked="" type="checkbox"/>	<input type="checkbox"/>	<input type="checkbox"/>
Runoff Reduction	<input type="checkbox"/>	<input type="checkbox"/>	<input type="checkbox"/>
Flow Diversion	<input type="checkbox"/>	<input type="checkbox"/>	<input type="checkbox"/>

Description: Inlet protection devices consist of a variety of manufactured sediment barriers and products, which are used to filter runoff before it enters the storm sewer system.

Typical Uses: Inlet protection is considered the last line of protection against releasing sediment into the stormwater system or a water body. Inlet protection should be considered around all stormwater intakes and culverts that accept runoff from disturbed areas.

Advantages:

- Provide one last opportunity to remove suspended particles from stormwater runoff.
- Areas requiring protection are easy to identify during both planning and construction.

Limitations:

- Available practices are not effective at removing fine particles.
- May be used improperly as the sole method of erosion and sediment control.
- Require high level of maintenance.
- Limited to treating runoff from areas of 1 acre or less.

Longevity: Varies by product; until sediment accumulates and clean out is required

SUDAS Specifications: Refer to [Section 9040, 2.18](#) and [3.24](#)

A. Description/Uses

Inlet protection can be provided by a variety of methods. A number of new manufactured products are currently available which claim to adequately filter runoff before it enters the storm sewer intake. The effectiveness of these products has yet to be determined.

The traditional method of providing inlet protection is to construct a filter at the opening. The filter is constructed from wire mesh or a steel plate, filter fabric, and crushed stone.

B. Design Considerations

Most inlet protection devices rely on filtering techniques or on ponding small volumes of water to remove suspended particles. In general, the only way to remove fine particles from suspension is to detain the runoff for an extended period of time. Because inlet protection devices do not have the ability to pond and store large volumes of water, they are generally considered ineffective at removing fine particles from suspension in runoff. However, they are the last line of protection against releasing sediment-laden runoff into a stormwater system or water body. In addition, they may provide some benefit by trapping a portion of the larger suspended particles.

Because of their relative inefficiency compared to other techniques, inlet protection devices should not be used on a project as the sole method of sediment removal.

The traditional method for providing inlet protection was to construct a filter at the opening. The filter was constructed from wire mesh, filter fabric, and crushed stone. Runoff flowing to the intake would percolate through the stone and filter fabric before entering the intake. This stone medium slowed the flow of water and filtered larger sediment particles from the water. Today, these methods have been replaced with alternative techniques and materials.

Figure 7E-20.01: Filter Tubes Used for Inlet Protection

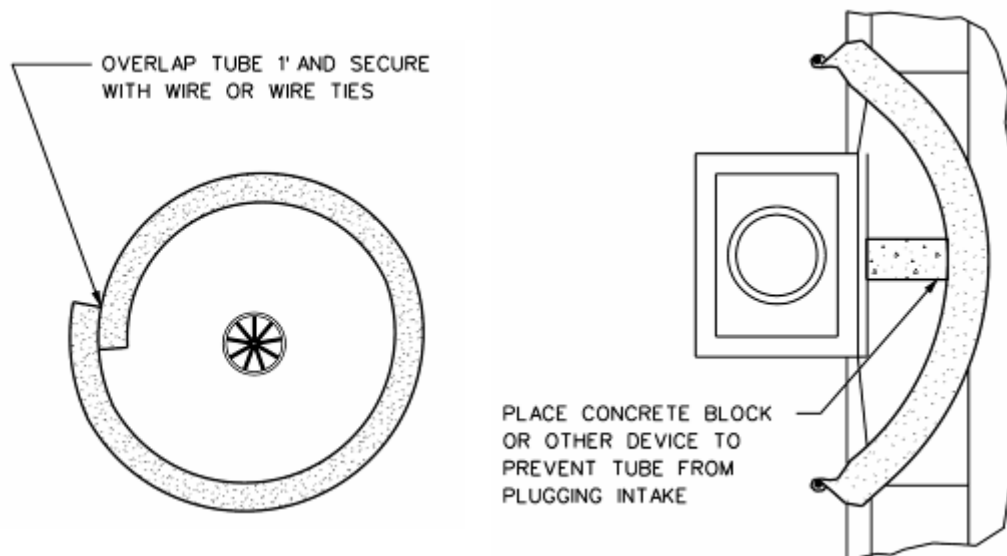

Silt fence, placed around the perimeter of an area intake, can also serve as an inlet protection device. Silt fence used around an intake should be reinforced with 6 by 6 inch welded wire fabric, placed on the inside of the silt fence and securely attached to the posts. Silt fence should not be placed where concentrated flows are expected.

Filter socks may be used around the perimeter of an area intake, or in locations where silt fence cannot be installed, such as paved areas. Refer to [Section 7E-4 - Filter Socks](#) for additional information on using filter socks around intakes.

A variety of manufactured products are available including storm intake filter socks, synthetic filter tubes for open throat curb intakes, intake inserts, pop-up filters for area intakes, and many others. These products should be used and installed according to the manufacturer's recommendations.

Using any inlet protection device that restricts the flow into the intake should be avoided for intakes that are on-grade. Because of the flow restriction, a majority of the flow to an on-grade intake will be bypassed to the downstream intake. This creates the potential for flooding problems downstream. To limit the potential for flooding, the drainage area to a protected inlet should be limited to 1 acre. For drainage areas larger than 1 acre, temporary sediment traps, flow diversion, or other methods should be considered.

C. Application

Inlet protection devices should be considered for inlets that are to receive runoff from small disturbed areas (less than 1 acre). These devices are used as a last line of defense against releasing sediment into the storm sewer or a water body.

D. Maintenance

Inlet protection devices are easily plugged, and may require a high level of maintenance. The devices should be cleaned out or replaced when standing water is still evident 48 hours after a rain event.

Flow Transition Mats



Source: ScourStop, 2006

<u>BENEFITS</u>			
	L	M	H
Flow Control			
Erosion Control			
Sediment Control			
Runoff Reduction			
Flow Diversion			

Description: Transition mats are a synthetic alternative to using rip rap.

Typical Uses: Used to dissipate energy and prevent scour at the transition from highly concentrate flow outlets to channel flow.

Advantages:

- Vegetated condition is more aesthetically pleasing than rip rap.
- Installation can be mowed with conventional equipment.
- May be utilized as a temporary measure.
- May be more economical than other “hard-armor” methods.
- Installation does not require any heavy equipment.

Limitations:

- Continuous flow channels may not support vegetation.
- Not appropriate for high velocity discharges (>16 fps).

Longevity: Permanent

SUDAS Specifications: Refer to [Section 9040, 2.19](#) and [3.25](#)

A. Description/Uses

A transition mat is a HDPE, UV stabilized, plastic sheet approximately 4 feet by 4 feet by 1/2 inch thick, comprised of multiple voids which allow vegetation to grow through, or small gravel and pebbles to accumulate and stabilize the area. The mat protects the area at pipe outlets from scour until the water spreading out in the channel diminishes the turbulent forces. The channel downstream of the outlet, where flow becomes uniform, must still be evaluated to ensure that the channel lining can withstand the anticipated shear stress.

B. Design Considerations

Generally, vegetation alone and a vegetated turf reinforcement mat (TRM) ([Section 7E-18](#)) can carry significant storm water shear, but cannot withstand the turbulence and concentrated flow generated by a hard surface such as storm sewers, culverts, or parking lots. At these locations, additional measures are usually required to prevent scour. Transition mats are one option for protecting that critical area.

Transition mats can be installed in several different configurations to meet the particular site requirements.

Transition mats installed over sod are good applications for parking lot outlets or pipe outlets conveying storm water through residential developments. The installation can be mowed with standard equipment and unsightly rock rip rap is avoided.

Installing sod and a Type 1 TRM under the transition mat adds a strong supporting element to the system. Vegetated TRMs already have proven shear force resistance of 12 pounds per feet. The sod eliminates the germination issue of a plain TRM installation, even though it adds a slight cost of material and labor, as well as potential short-term irrigation needs. Appropriate uses for a transition mat over a Type 1 TRM and sod would be 24 to 48 inch storm water pipes.

Transition mats may also be used without sod. A transition mat with a Type 1 TRMs over bare soil might be used in situations where turfgrass is not desired, such as a rural area, or as a temporary installation. When used without sod, the flows should be slow and the area fairly flat to encourage sediment accumulation in the voids, where vegetation could also start. Pipe sizes should be limited to 24 inches.

Higher flow installations without sod can be accommodated using a higher class, Type 3 TRM over the bare soil. This type of installation may be applicable for temporary, pre-vegetation erosion control use (temporary meaning remove and reinstall when vegetation can be established), or as a permanent installation requiring substantial soil protection and vegetation growth over time. This installation could also be used in a streambed, where the mats would collect small gravel and sediment in the voids and appear naturally stabilized.

Installations with continuous low flows, such as irrigation over charge, should utilize a sub-surface drainage system directly downstream of the outlet to drain that low flow from the surface, thus allowing vegetation to properly establish. Of course, adequate slope is required for a subdrain system. In some instances, marsh plants could be planted into a transition mat and TRM combination as another solution.

For installations where the slope of the discharge area or channel is greater than the outlet, but not a waterfall situation, transition mats should perform as specified. When the slope of the discharge area or channel is flatter than the outlet, and the grade break between the two exceeds 8%, the flow velocities and vector forces directed into the transition mat should be considered to determine if a flow transition mat is appropriate for the situation.

A temporary installation, for example the outlet of a temporary slope drain, can be readily achieved with a transition mat and TRM combination. Vegetation would generally not be necessary or desired, but scour protection would be quickly achieved, and the materials could be easily picked up and moved to another area on demand.

Transition mats do not dissipate energy by impact like rip rap, but generally rely on the expansion area downstream to dissipate scour forces. The expansion area should be as wide and flat as possible. Channel side slopes that restrict expansion require protection with either a TRM or other means.

In addition to the potential scour area at the outlet, the channel downstream of the transition mat should be evaluated to ensure that it can carry the anticipated flows without eroding the streambank. Additional information on evaluating channel linings can be found in [Section 7E-23 - Grass Channel](#) and [7E-18 - Turf Reinforcement Mats](#).

C. Application

Outlet protection should be designed to withstand the 10 year storm event. The following table lists the recommended dimensions for transition mat and TRM (if used) installations based upon pipe diameter.

Table 7E-21.01: Flow Transition Mat Application

Pipe Diameter (inches)	Discharge ¹ (cfs)	Transition Mats		TRM
		Width (ft) x Length (ft)	Quantity	Width (ft) x Length (ft)
12	8	4 x 4	1	6 x 8
24	30	4 x 8	2	11 x 12
36	75	8 x 12	6	17 x 16
48	100	12 x 16	12	23 x 20

¹ If the design discharge exceeds that for the diameter shown, alternative methods of outlet protection should be provided.

D. Maintenance

Transition mats are generally permanent installations, and maintenance should not be necessary. Utilized in a temporary installation, the transition mats and TRMs can be picked up and moved when appropriate.

Temporary Erosion Control Seeding



<u>BENEFITS</u>				
	L M H			
Flow Control	<table border="1" style="display: inline-table;"> <tr> <td style="width: 20px; height: 15px; background-color: black;"></td> <td style="width: 20px; height: 15px; background-color: white;"></td> </tr> </table>			
Erosion Control	<table border="1" style="display: inline-table;"> <tr> <td style="width: 20px; height: 15px; background-color: black;"></td> <td style="width: 20px; height: 15px; background-color: black;"></td> </tr> </table>			
Sediment Control	<table border="1" style="display: inline-table;"> <tr> <td style="width: 20px; height: 15px; background-color: black;"></td> <td style="width: 20px; height: 15px; background-color: white;"></td> </tr> </table>			
Runoff Reduction	<table border="1" style="display: inline-table;"> <tr> <td style="width: 20px; height: 15px; background-color: black;"></td> <td style="width: 20px; height: 15px; background-color: white;"></td> <td style="width: 20px; height: 15px; background-color: white;"></td> </tr> </table>			
Flow Diversion	<table border="1" style="display: inline-table;"> <tr> <td style="width: 20px; height: 15px; background-color: white;"></td> <td style="width: 20px; height: 15px; background-color: white;"></td> <td style="width: 20px; height: 15px; background-color: white;"></td> </tr> </table>			

Description: Temporary seeding is a means of growing a short-term (less than one-year) vegetative cover on disturbed areas that may be in danger of erosion. The purpose is to stabilize disturbed areas with existing or expected high rates of soil erosion by water or wind, reduce damage from sediment and runoff to downstream areas, and improve water quality.

Typical Uses: Temporary seeding may be used to stabilize rough-graded disturbed areas that will not have permanent stabilization or further work performed on them for a period of 21 days or more, and which require temporary stabilization for a period of less than one year.

Advantages:

- Relatively low cost.
- Competes with undesirable vegetation such as noxious weeds.
- Reduces flow velocity, thus reducing erosion potential.
- Traps suspended sediment.
- Improves construction site appearance.
- Reduces maintenance and clean out requirements associated with other erosion control structures (i.e. sediment basin cleanout frequency will be reduced if site is stable).
- Effective measure for dust control.

Limitations:

- Requires sufficient time and moisture to establish.
- Planted areas are susceptible to wind and water erosion until vegetation is established.
- Seasonal limitations on planting may not coincide with construction schedule.
- Method is only effective for one growing season.

Longevity: One growing season

SUDAS Specifications: Refer to [Section 9010 \(Seeding\)](#)

A. Description/Uses

Temporary seeding for construction site erosion control consists of planting appropriate rapidly growing vegetation on disturbed/denuded soil areas to reduce soil loss (erosion and sedimentation), decrease stormwater runoff volume, and lessen problems associated with mud and dust production from bare, unprotected soil surfaces. Through seeding, a fibrous root system is established. This holds the soil in place and provides a canopy over the soil, protecting it from raindrop impact. Typical applications for temporary seeding include stabilizing the denuded surface of excavations, slopes, diversions, dams, sediment basins, road embankments, and stockpiles.

The NPDES General Permit No. 2 requires that all disturbed areas where no construction activities are scheduled for a period of 21 calendar days or more, be stabilized within 14 days of the final construction activity. Temporary seeding is one way to meet this requirement.

B. Design Considerations

The following should be considered for all sites that are to be stabilized with either temporary or permanent seeding.

1. **Site Stabilization:** Minimize steep slopes, which increase the erosion hazard, and make seedbed preparation difficult. Concentrated flows should be diverted away from the seeding area.
2. **Sediment and Water Control Devices:** Prior to seeding, necessary control practices such as dikes, swales/waterways, or sediment basins or diversions should be installed.
3. **Seeding Methods:** There are four seeding methods to consider:
 - a. Broadcast seed spreader/cyclone seeder
 - b. Mechanical drill or cultipacker
 - c. Hydroseeder in which the seed is intermixed with mulch and water to creates a slurry.
 - d. Pneumatic seeder in which the seed is intermixed with compost or a compost/soil blend

When hydroseeding and pneumatic seeding are utilized, the surface may be left with a more irregular surface, since these practices will fill small depressions and cover small bumps. These two types of seeding methods can be used in situations where slope and accessibility is a limiting factor and seedbed preparation is not possible, or where the application of seed, mulch and fertilizer (if necessary) in one operation is desirable.

Hand broadcasting seed may be utilized for small or inaccessible areas; however, it is not recommended for larger areas because of the difficulty in achieving a uniform distribution.

4. **Seedbed Preparation:** Seedbed preparation is essential for the vegetation's ability to germinate and grow. Seedbed preparations considerations include:
 - a. Topsoiling is not necessary for temporary seeding, though it may improve the chances of vegetation establishment. When the area is crusted or hardened, the soil surface should be loosened by disking, raking, harrowing, or other acceptable means to a depth of approximately 2 inches. If the area has been recently loosened, no further roughening is required.

- b. Soil compaction severely hinders seeding success rate and increases runoff rates. If the area has been compacted by heavy equipment, the surface to be seeded should be chisel plowed to a depth of 6 to 12 inches once heavy equipment has been removed from the area.
 - c. The soil pH should have a range of 5.5 to 7.5. Where soils are known to be highly acidic (pH 6.0 and lower), lime should be applied at the rate recommended by the soil-testing laboratory.
 - d. Fertilizer application is required for temporary seeding.
5. **Seed Mixture:** Unless a specific seed mixture is required, the seed mixtures described in [SUDAS Specifications Section 9010](#) may be utilized. These are annual seed mixtures and are only intended to provide protection for one growing season (6 to 8 months). For applications requiring protection longer than one growing season, reseeding in the spring or dormant seeding in the fall may be required. Alternatively, areas which will not be disturbed for a period greater than can be protected by a temporary seed mixture, should have permanent seeding applied (refer to [Section 7E-24](#))

Table 7E-22.01: Temporary Erosion Control Mixes

Seed Mixture	Allowable Seeding Dates
Spring Mix	March 1 - May 20
Summer Mix	May 21 - August 14
Fall Mix	August 15 - September 30

Source: [SUDAS Specifications Section 9010](#)

- 6. **Weather:** When seeding, be aware of the weather. Do not seed when heavy rainfall is predicted, during windy weather or on wet/frozen ground (hydroseeding and pneumatic seeding may be an exception to seeding on wet/frozen ground).
- 7. **Matting:** A rolled erosion control product is recommended for slopes steeper than 3:1. RECPs may also be required for flatter slopes greater than 100 feet in length, to hold the seed in place and protect new vegetation from runoff until it becomes established. Refer to [Section 7E-5 - Temporary Rolled Erosion Control Products](#).
- 8. **Mulching:** For temporary seeding, mulching is advised when seeding in the summer or during excessively hot or dry weather to maintain moisture levels; in the fall for winter cover; on slopes steeper than 3:1; and on adverse soils (shallow, rocky, or high in clay or sand). Mulching is not advised in concentrated flow situations. Refer to [Section 7E-17 - Erosion Control Mulching](#).
- 9. **Moisture:** If normal rainfall is insufficient to ensure vegetation establishment, mulching, matting, or controlled watering should be completed to keep seeded areas adequately moist.

C. Application

In order to achieve the appropriate vegetation density, temporary seed mixtures and fertilizer should be applied at the rates specified in the SUDAS Specifications.

D. Maintenance

Once the area is seeded, it should not be disturbed and should be protected from traffic. Newly seeded areas should be inspected weekly as part of the overall erosion control inspection, to ensure that grass is growing satisfactorily. Areas that have bare spots or where erosion has occurred, should be re-seeded. Temporary seeding should be maintained until the area is again disturbed by construction, or permanent stabilization is achieved.

E. Time of Year

The temporary seeding mixture used should be based upon the time of year as indicated in Table 7E-22.01. The dates given are approximate and may be adjusted to account for annual weather patterns.

Grass Channel



Source: NRCS photo gallery

<u>BENEFITS</u>			
	L	M	H
Flow Control	■	□	□
Erosion Control	■		
Sediment Control	■	□	□
Runoff Reduction	■	□	□
Flow Diversion	□	□	□

Description: Grass channels consist of ditches, swales, or waterways that are lined with vegetation to stabilize the surface from erosion.

Typical Uses: Used to carry intermittent, low to moderate concentrated flows of surface runoff.

Advantages:

- Low cost method of conveying surface runoff.
- Highly effective for controlling channel erosion for low to moderate flows.
- Aesthetically pleasing.
- Reduces flow velocity and removes sediment.

Limitations:

- Cannot withstand forces from high flows.
- There may be some difficulty establishing vegetation.
- Not suitable for channels that carry constant flows, or that remain submerged for extended periods of time.

Longevity: Permanent

SUDAS Specifications: Refer to [Section 9010 \(Seeding\)](#) or [9020 \(Sodding\)](#)

A. Description/Uses

Grass channels consist of swales, ditches, and waterways that are lined with permanent vegetation. The purpose of the vegetation is to stabilize the surface of the channel and prevent erosion from concentrated stormwater flow.

Because these structures are lined with vegetation, they cannot be used for channels which have constant flow, or which will be submerged for extended periods of time.

Grass channels are the least costly and most aesthetically pleasing option for lining channels.

B. Design Considerations

As water flows through any conduit or channel, the surface of the conduit or channel imparts drag on the flowing water. The amount of drag a particular surface will create is related to the commonly known Manning's "n" coefficient. This drag force not only slows the flow of the water, but also imparts a corresponding force onto the lining of the channel. This force is known as shear stress.

The ability of a channel to withstand shear stress is dependent on the properties of the lining. If the shear stress imposed on the bottom and sides of a channel by the flowing stormwater exceeds the ability of the channel lining to withstand it, the lining will be moved or damaged. Various types of vegetation provide different levels of resistance to shear. Table 7E-23.01 lists the various classifications of vegetation that have been established and analyzed.

Prior to movement of the lining, the underlying soil is protected from the erosive forces of the flowing water. Therefore, the erodibility of the underlying soil has little effect on the permissible shear stress of the lining. However, if the grass lining is moved or damaged, the underlying soil properties become a significant factor in determining the degree of erosion that will occur.

Calculating shear stress in a channel is a two step process. First, the depth of flow in the channel is determined with Manning's equation. For temporary stabilization, the channel liner should be designed to carry a 2 year storm event. For permanent stabilization, the liner should be designed for a 10 year event.

For most channel lining materials, Manning's n value does not vary significantly as the depth of flow varies, and is normally assumed to be constant. For grass channels however, the n value varies greatly with the depth of flow. This variation is caused by the reaction of the grass to the flow. As flow depth increases, the grass is bent over, thereby reducing its height and changing the resistance it imparts on the flow.

The following equations, along with the vegetation data listed in Table 7E-23.02, can be used to calculate the Manning value for a given depth of flow and vegetation type. For vegetated conditions, NRCS has determined that actual Manning's n values range only from 0.02 to 0.5. When calculated values fall outside of this acceptable range, the designer should use the upper or lower limit of the range. If the denominator of Equation 7E-23.01 is zero or less than zero, a Manning's n value of 0.5 should be used.

$$n = \frac{R^{1/6}}{19.97 \left(\log(44.8 \times h^{0.6} \times \text{MEI}^{-0.4}) + \log(R^{1.4} \times S^{0.4}) \right)} \quad \text{Equation 7E-23.01}$$

Where:

- n = Manning's coefficient (dimensionless)
- R = Hydraulic radius (ft.)
- h = Average height of vegetation; from Table 7E-23.01 (ft)
- MEI = Stiffness factor; from Table 7E-23.02 (lb.· ft²)
- S = Channel slope (ft/ft)

Source: Chen & Cotton, 1988 (HEC-15)

Because the Manning coefficient changes with depth, calculating the depth of flow is an iterative process. Once the flow depth is determined, the shear stress on the channel liner is determined by the following equation:

$$\tau_d = \gamma \times d \times S \quad \text{Equation 7E-23.02}$$

Where:

- τ_d = Shear stress in channel at maximum depth (lbs/ft²)
- γ = Unit weight of water (62.4 lbs/ft³)
- d = Depth of flow (ft)
- S = Channel slope (ft/ft)

The shear stress distribution along the wetted perimeter of a channel is not uniform, as indicated in Figure 7E-23.01. In a trapezoidal channel, the peak shear stress in a straight channel occurs at the center of the bottom of the channel. The stress in the corners of the channel approaches zero. The peak shear stress along the sides of a straight channel occur near the bottom third of the channel.

Figure 7E-23.01: Stress Distribution in a Trapezoidal Channel

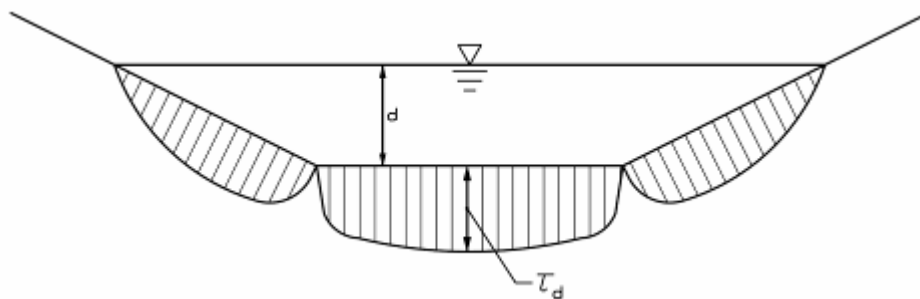

Source: Adapted from Chen & Cotton, 1988 (HEC-15)

If the flow travels around a bend, the current imposes additional forces on the channel as the flow is redirected. These forces result in increased shear stress on the bottom and sides of the channel. The additional shear stress imposed on the channel is related to the ratio of the radius of the bend, R_c , and the bottom width of the channel, b . As the bend becomes sharper, the shear stress increases. The maximum shear stress in the bend is determined by multiplying the calculated shear stress in a straight section of channel by the bend coefficient, K_b (Equation 7E-23.03). K_b is determined from Figure 7E-23.02.

$$\tau_b = K_b \tau_d$$

Equation 7E-23.03

Figure 7E-23.02: Bend Coefficient for Maximum Shear Stress in Channel Bends

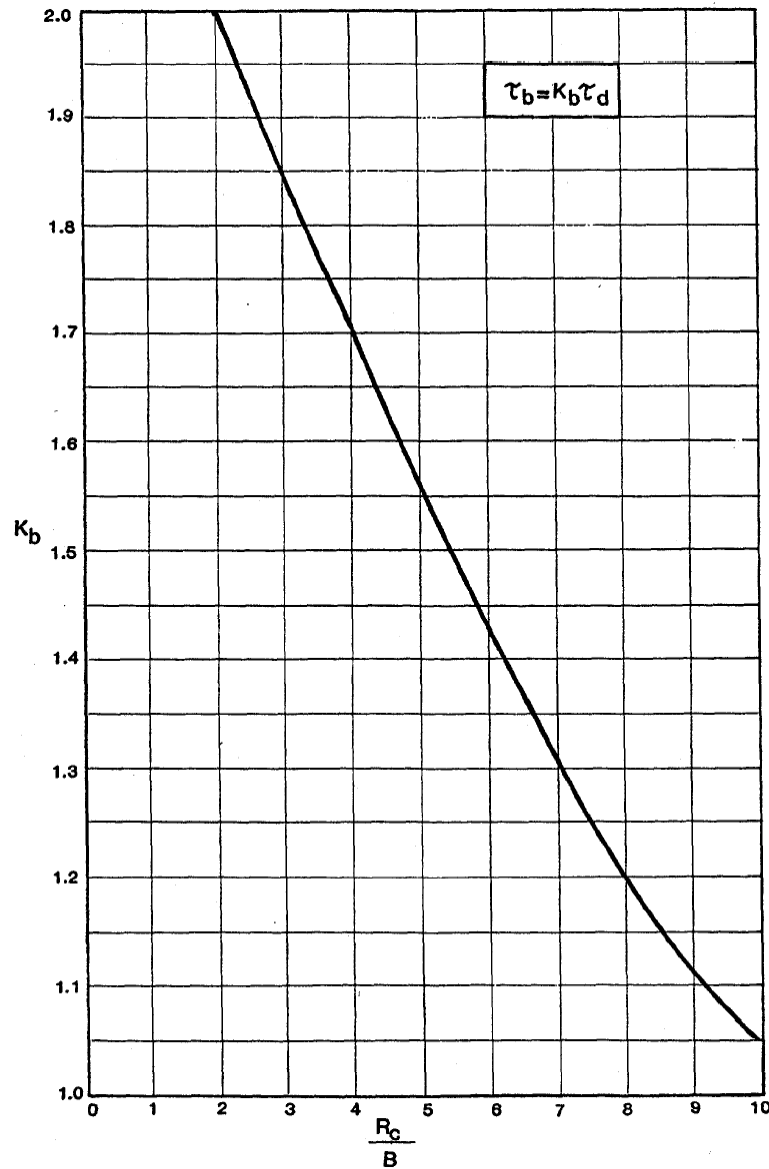

Source: Chen & Cotton, 1988 (HEC-15)

As flow travels around a bend, the increased shear stresses begin along the inside radius and move toward the outside. These increased stresses are also transmitted down the channel for a distance L_p , due to the turbulence created in the flow as it traveled around the bend (see Figure 7E-23.03). This distance can be determined by Equation 7E-23.04. When additional channel protection is provided in the bend, it should also be extended through this length.

$$L_p = 0.604 \frac{R^{7/6}}{n}$$

Equation 7E-23.04

Where:

- L_p = Length of protection required downstream of bend, ft
 R = Hydraulic radius
 n = Manning's coefficient

Figure 7E-23.03: Shear Stress Distribution in a Channel Bend

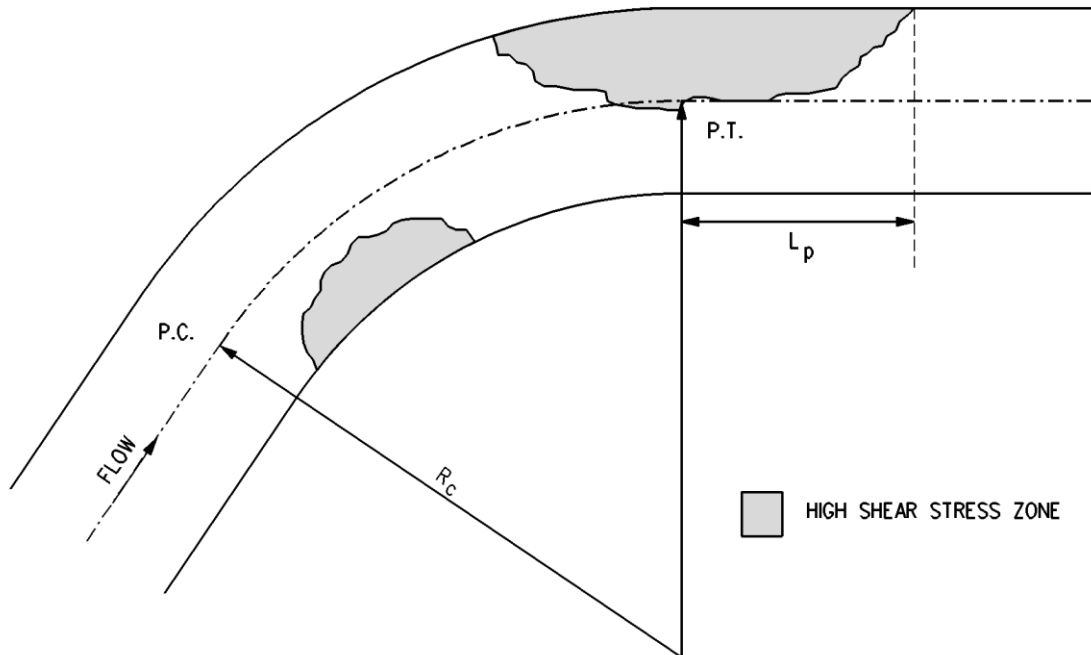

Source: Adapted from Chen & Cotton, 1988 (HEC-15)

Once the anticipated shear stress on the channel liner is determined, it is compared to the allowable shear stress values of the proposed vegetation. If the calculated shear stress value exceeds the allowable shear stress of the liner, additional protection may be required. Depending on the level of shear stress anticipated, additional protection may be provided by an alternate type of vegetation, by reinforcing the vegetation with a turf reinforcement mat, lining the channel with rip rap, or modifying the geometrics of the channel.

For channels where establishment of vegetation may be difficult, a rolled erosion control product may be considered. A complete discussion on RECPs can be found in [Section 7E-5](#).

A more complete discussion on channel stabilization is provided in [Chapter 2 - Stormwater](#).

Table 7E-23.01: Classification of Vegetation

Vegetation Class	Cover	Condition
A	Weeping lovegrass	Excellent stand, tall (average 30")
	Yellow bluestem ischaemum	Excellent stand, tall (average 36")
B	Kudzu	Very dense growth, uncut
	Bermuda grass	Good stand, tall (average 12")
	Native grass mixture (little bluestem , bluestem, blue grama , other long and short Midwest grasses)	Good stand, unmowed
	Weeping lovegrass	Good stand, tall (average 24")
	Lespedeza serices	Good stand, not woody, tall (average 19")
	Alfalfa	Good stand, uncut (average 11")
	Weeping lovegrass	Good stand, unmowed (average 13")
	Kudzu	Dense growth, uncut
	Brome, smooth	Good stand, mowed (average 12" to 15")
	Tall fescue	Good stand, uncut (average 18")
	Tall fescue with birdsfoot trefoil	Good stand, uncut (average 18")
	Grass - Legume mixture - Timothy, Smooth brome grass, or Orchardgrass	Good stand, uncut (average 20")
	Blue grama	Good stand, uncut (average 13")
	C	Crabgrass
Bermuda grass		Good stand, mowed (average 6")
Red top		Good stand, headed (15" to 20")
Common lespedeza		Good stand, uncut (average 11")
Grass-legume mixture - Summer (orchard grass, redtop, Italian ryegrass, and common lespedeza)		Good stand, uncut (6" to 8")
Centipede grass		Very dense cover (average 6")
Kentucky bluegrass		Good stand, headed (6" to 12")
D		Bermuda grass
	Common lespedeza	Excellent stand, uncut (average 4.5")
	Buffalo grass	Good stand, uncut (3" to 6")
	Grass-legume mixture fall, spring (orchard grass, redtop, Italian ryegrass, and common lespedeza)	Good stand, uncut (4" to 5")
	Kentucky bluegrass or Lespedeza sericea	Good stand, cut to 2" height. Very good stand before cutting.
	Red fescue	Good stand (headed (12" to 18"))
E	Bermuda grass	Good stand, cut to 1.5" height
	Bermuda grass	Burned stubble

Note: covers classified have been tested in experimental channels. Covers were green and generally uniform. Items shown in **bold** are seed varieties included in the SUDAS Specifications.

Source: Chen & Cotton, 1988 (HEC-15) and USDA NRCS, 1986

Table 7E-23.02: Vegetation Properties

Vegetation Class	Permissible Shear Stress (lb/ft ²)	Average Height, h (feet)	Stiffness, MEI (lb/ft ²)
A	3.7	3.0	725
B	2.1	2.0	50
C	1.0	0.66	1.2
D	0.6	0.33	0.12
E	0.35	0.13	0.012

Source: Chen & Cotton, 1988 (HEC-15)

C. Application

Grassed channels are an excellent low-cost stabilizing method for swales and ditches that carry intermittent low to moderate concentrated flows.

D. Maintenance

Proper maintenance of the channel is critical. For designs where vegetation is assumed to be unmowed or at a minimum height, it is important to ensure that the vegetation in the channel is maintained in the manner intended. Mowing a channel, which was not designed to be kept at a short height, could result in failure of the grass channel. If there is a possibility that the channel could be mowed, it should be designed as such.

Newly seeded or sodded areas should be maintained and watered as required to ensure establishment of the grass. See [Sections 7E-22 - Temporary Erosion Control Seeding](#) and [7E-25 - Sodding](#).

E. Time of Year

Grass channel liners require the vegetation to be well-established in order to provide maximum protection from erosion. Seeding a channel near the end of the annual seeding window may not allow enough time for the vegetation to develop sufficiently to resist flows from winter snowmelt or spring rains.

F. Design Example

Assume a grass channel with a 3 foot bottom, 4:1 side slopes, and a slope of 1% is designed to carry 24 cfs. Determine if the proposed Class C vegetation is adequate.

Solution:

First, use Manning's equation to find the depth of flow. This can be done through a trial and error process, or by using various tables and charts. For grass channels, Manning's n value varies, and must be calculated based upon the depth of flow. From Table 7E-23.02, the average height, h, for Class C vegetation is 0.66 ft, the stiffness, MEI, is 1.2 lb-ft², and the permissible shear stress is 1.0 lbs/ft².

Trial 1 - Assume a trial depth of 1.2 feet.

$$\text{Area of Flow, } A = (b + Z \times d) \times d = (3 + 4 \times 1.2) \times 1.2 = 9.4 \text{ ft}^2$$

$$\text{Wetted Perimeter, } P = b + 2 \times \sqrt{d^2 + (Zd)^2} = 3 + 2 \times \sqrt{1.2^2 + (4 \times 1.2)^2} = 12.9 \text{ ft}$$

$$\text{Hydraulic Radius, } R = A/P = 9.4/12.9 = 0.73 \text{ ft}$$

Manning coefficient (from Equation 7E-23.01):

$$n = \frac{0.73^{1/6}}{19.97(\log(44.8 \times 0.66^{0.6} \times 1.2^{-0.4}) + \log(0.73^{1.4} \times 0.01^{0.4}))} = 0.092$$

$$\text{Solving Manning's yields: } Q = 1.49/n AR^{2/3} S^{1/2} = (1.49/0.092)(9.4)(0.73)^{2/3}(0.01)^{1/2} = 12.2 \text{ cfs}$$

Since 12.2 cfs is lower than the design value of 24 cfs, a larger depth should be assumed.

Trial 2 - Assume a depth of 1.5 feet.

Following the procedure for Trial 1: $A = 13.5$; $P = 15.4$; $R = .88$; $n = 0.077$; $Q = 24$ cfs

Now that the depth of flow is known, the shear stress on the channel bottom can be determined by Equation 7E-23.02.

$$\tau_{\max} = \gamma \times d \times S = 62.4 \times 1.5 \times 0.01 = 0.94 \text{ lbs/ft}^2$$

Since the maximum shear stress of 0.94 lbs/ft² is less than the capacity of the grass channel liner (1.0 lbs/ft²), the design should be adequate to protect the channel from erosion.

Permanent Seeding



Source: Iowa NRCS, 2004

BENEFITS

	L	M	H
Flow Control	█	█	█
Erosion Control	█	█	█
Sediment Control	█	█	█
Runoff Reduction	█	█	█
Flow Diversion	█	█	█

Description: Permanent seeding is a means of establishing permanent, perennial vegetative cover on disturbed areas. The purpose of permanent seeding is to prevent erosion, remove sediment from runoff, reduce the volume of runoff, and improve water quality.

Typical Uses: Permanent seeding is used to stabilize the ground after grading and land-disturbing activities have been completed, or whenever construction activities will be halted for a time period longer than temporary seeding can provide protection (i.e. one growing season).

Advantages:

- Relatively low cost.
- Most common method of providing permanent stabilization of disturbed ground.
- Highly effective as a stand-alone measure in all but the most extreme situations (i.e. continuously flowing channels, steep slopes, high flows, etc.).
- Competes with undesirable vegetation and noxious weeds.
- Vegetation absorbs water, reducing the volume of stormwater runoff.
- Vegetation filters out sediment and other pollutants, improving water quality.
- Provides an aesthetically pleasing, finished look to the site.

Limitations:

- Does not provide instant protection; requires sufficient time and moisture to establish.
- Difficult to establish in area subjected to concentrated flows.
- Seasonal limitations on planting may not coincide with construction schedule.

Longevity: Permanent

SUDAS Specifications: Refer to [Section 9010 \(Seeding\)](#)

A. Description/Uses

Permanent seeding consists of planting perennial vegetation on disturbed/denuded soil areas. Through seeding, a fibrous root system is established. This holds the soil in place and provides a canopy over the soil, protecting it from raindrop impact. The vegetation slows the velocity of the runoff, protecting the surface from sheet and rill erosion, while allowing suspended sediment to be removed. Vegetation also absorbs water from the soil, reducing the total volume of runoff.

B. Design Considerations

Permanent seeding is the most commonly used method of providing permanent surface stabilization. It is an economical, long-term method of providing highly effective stabilization, and is aesthetically pleasing. However, in order to be effective, the designer must select the proper vegetation and recognize the practical limits of vegetation.

The following should be considered for all sites prior to permanent seeding:

- 1. Site Stabilization:** Steep slopes, which increase the erosion hazard, should be minimized. Vegetation alone is normally an effective method of stabilizing slopes that are 3:1 or flatter. For slopes steeper than 3:1, or for flatter slopes carrying runoff from upland areas, a rolled erosion control product may be required to provide slope stabilization until the vegetation is established.

In addition, slopes that are very steep (2:1 or greater) and areas that receive intermittent concentrated flows may require application of a turf reinforcement mat to provide permanent reinforcement to the vegetation.

- 2. Sediment and Water Control Devices:** Measures should be taken to divert sheet and concentrated flows away from areas that are to be seeded until the vegetation is established.
- 3. Seeding Methods:** There are four seeding methods to consider:
 - a. Broadcast seed spreader/cyclone seeder
 - b. Mechanical drill or cultipacker
 - c. Hydroseeder in which the seed is intermixed with mulch and water to create a slurry
 - d. Pneumatic seeder in which the seed is intermixed with compost or a compost/soil blend

When hydroseeding and pneumatic seeding are utilized, the surface may be left with a more irregular surface, since these practices will fill small depressions and cover small bumps. These two types of seeding methods can be used in situations where slope and accessibility is a limiting factor and seedbed preparation is not possible, or where the application of seed, mulch and fertilizer (if necessary) in one operation is desirable.

Hand broadcasting seed may be utilized for small or inaccessible areas; however it is not recommended for larger areas because of the difficulty in achieving a uniform distribution.

- 4. Seedbed Preparation:** Proper seedbed preparation is essential for the seed to germinate and develop into a dense, healthy stand of vegetation.
 - a. Subsoil Preparation:** Newly graded areas may be severely compacted by the weight of heavy earth-moving and construction equipment. Disking or tilling reduces compaction in

the uppermost layer of the soil, providing an adequate growing bed for the seed; however, the soil below this level may remain severely compacted. This compacted layer acts as an impermeable barrier, slowing or preventing the infiltration of water into the ground. Infiltration of precipitation reduces runoff, and recharges groundwater supplies. Techniques for reducing ground compaction, such as deep tillage, should be investigated.

- b. Topsoil:** In order to provide an adequate growing medium, a minimum of 6 inches of topsoil should be placed over the disturbed area prior to seeding. Deeper topsoil depths (8-12 inches or greater) are desirable as they increase the organic matter available for use by the plants, allow for deeper root penetration and increase the moisture holding ability of the soil. These benefits will increase the drought tolerance and long-term health of the vegetation. Where sufficient topsoil is not available, composted material may be incorporated at the rate of 1 inch of compost for every 3 inches of deficient topsoil. This will increase the organic matter content of the soil, and provide an adequate growing medium for vegetation.
- c. Soil pH:** The soil pH should have a range of 5.5 to 7.5. Where soils are known to be highly acidic (pH 6.0 and lower), lime should be applied at the rate recommended by the soil-testing laboratory.
- d. Soil Fertilization:** Soil fertilization is required for permanent seeding. Fertilizer rates specified in the SUDAS Specifications are recommended for most applications. Sites without sufficient topsoil or low organic matter may require higher fertilizer rates, or fertilizer with a higher nitrogen concentration.

5. Seeding Properties:

- a. General Mixtures:** The SUDAS Specifications provide a number of seed mixes that are acceptable for most general applications. These mixes and a description of their intended usage are shown in Table 7E-24.01.

Table 7E-24.01: SUDAS Seeding Mixtures

Description	Typical Uses	Allowable Seeding Dates
Type 1 - Permanent Lawn Mixture	Used for residential and commercial turf sites. Fertilized; typically mowed.	March 1 - May 31 August 10 - September 30
Type 2 - Permanent Cool - Season Mixture for Slopes and Ditches	Not typically mowed. Reaches maximum heights of 2 to 3 feet; low fertility requirements; grows in spring and fall; can go dormant in summer.	March 1 - May 31 August 10 - September 30
Type 3 - Permanent Warm-Season Slope and Ditch Mixture	Not typically mowed. Reaches heights of 5 to 6 feet; stays green throughout summer; responds well to being burned in spring; do not apply fertilizer.	March 1 - June 30
Type 4 - Temporary Erosion Control Mixture	Short-lived (6 to 8 months) mix for erosion control.	March 1 - September 30 (seeding dates vary by seasonal mix)
Wetland Seeding	Used in areas designated for wetland grass seeding.	April 1 - June 30 August 1 - August 31
Native Grass and Wildflower Seeding	Used in areas designated for native grass and wildflower seeding.	April 1 - June 30

- b. Special Mixtures:** Some sites require specifically designed or selected mixtures to address individual site characteristics. Site characteristics that require special consideration include very shady areas, detention ponds, wet areas, streambanks, severe slopes, and areas with poor soils.
- 6. Weather:** When seeding, be aware of the weather. Do not seed when heavy rainfall is predicted, during windy weather or on wet/frozen ground (hydroseeding and pneumatic seeding may be an exception to seeding on wet/frozen ground).
- 7. Matting:** A rolled erosion control product is recommended for slopes steeper than 3:1. RECPs may also be required for flatter slopes greater than 100 feet in length, to hold the seed in place and protect new vegetation from runoff until it becomes established. Refer to [Section 7E-5 - Temporary Rolled Erosion Control Products](#).
- 8. Mulching:** Mulching is recommended for most permanent seeding applications. Mulch aids in stabilizing the surface until vegetation is established. Mulch also helps retain soil moisture and maintains temperature conditions favorable to germination. Refer to [Section 7E-17 - Erosion Control Mulching](#).
- 9. Moisture:** If normal rainfall is insufficient to ensure vegetation establishment, mulching, matting, or controlled watering should be completed to keep seeded areas adequately moist.

C. Application

In order to achieve a dense, healthy stand of vegetation that will provide long-term surface stabilization, seed mixtures and fertilizer should be applied at the rates specified in the SUDAS Specifications.

D. Maintenance

Once the area is seeded, it should not be disturbed and should be protected from traffic. Newly seeded areas should be inspected weekly as part of the overall erosion control inspection, to ensure that grass is growing satisfactorily. Areas that have bare spots, or where erosion has occurred should be re-seeded.

E. Time of Year

The seed mixtures within the SUDAS Specifications should be placed within the dates specified, or as weather conditions allow and if approved by the Jurisdictional Engineer.

Sodding



Source: Welch, J.

<u>BENEFITS</u>				
	L M H			
Flow Control	<table border="1" style="width: 100%; height: 15px;"> <tr> <td style="width: 33%; background-color: black;"></td> <td style="width: 33%;"></td> <td style="width: 33%;"></td> </tr> </table>			
Erosion Control	<table border="1" style="width: 100%; height: 15px;"> <tr> <td style="width: 100%; background-color: black;"></td> </tr> </table>			
Sediment Control	<table border="1" style="width: 100%; height: 15px;"> <tr> <td style="width: 33%; background-color: black;"></td> <td style="width: 33%;"></td> <td style="width: 33%;"></td> </tr> </table>			
Runoff Reduction	<table border="1" style="width: 100%; height: 15px;"> <tr> <td style="width: 33%; background-color: black;"></td> <td style="width: 33%;"></td> <td style="width: 33%;"></td> </tr> </table>			
Flow Diversion	<table border="1" style="width: 100%; height: 15px;"> <tr> <td style="width: 33%;"></td> <td style="width: 33%;"></td> <td style="width: 33%;"></td> </tr> </table>			

Description: A section of grass-covered surface soil held together by matted roots that is cut in pre-determined sections, transported, and delivered directly to the job site ready to install.

Typical Uses: Sod is placed to prevent erosion and damage from sediment and water by stabilizing the soil surface and to improve the visual quality and utility of the area quickly. Sod is typically used in residential or commercial areas where prompt use or aesthetics are important such as building entrance zones or high activity areas. Sod is also used in areas of intermittent concentrated flow such as waterways and channels. Sod may also be utilized in critical areas such as storm drain inlets, steep slopes, and any area where conditions make seeding impractical or impossible.

Advantages:

- Provides immediate erosion and dust control.
- Provides finished landscape appearance at time of installation.
- Reduces likelihood of weed growth.
- Placement can occur any time soil moisture is adequate and ground is not frozen.
- Rapid stabilization of surfaces for traffic areas, channel linings, or critical areas.

Limitations:

- More costly when compared to seeding and mulching.
- Vegetation selection is limited (typically a cool-season bluegrass based mix).
- Time is necessary for root establishment.
- Watering is required to ensure establishment.

Longevity: Permanent

SUDAS Specifications: Refer to [Section 9020 \(Sodding\)](#)

A. Description/Uses

Sodding consists of transplanting turf-type vegetation to promptly stabilize areas that are subject to erosion. Sod may be field sod or commercial sod, a cultured product utilizing specific grass species. A sodded area provides one of the best methods for preventing soil particles from leaving the site, providing immediate protection against soil erosion from water and wind.

B. Design Considerations

The following should be considered for all sites stabilized with sod.

- 1. Fertilization:** Test soil to determine the exact requirements for lime and fertilizer. Soil tests should be conducted by the state soil testing lab or a reputable commercial laboratory. Information on soil testing and testing services is available from the Iowa State University Extension (<http://www.extension.iastate.edu/>).
- 2. Site Preparation:** In areas where topsoil has been stripped, a sodbed should be constructed by spreading a minimum of 6 inches of topsoil prior to sodding. Deeper topsoil depths (8 to 12 inches or greater) are desirable as they increase the organic matter available for use by the plants, allow for deeper root penetration and increase the moisture holding ability of the soil. These benefits will increase the drought tolerance and long-term health of the vegetation. Where sufficient topsoil is not available, composted material may be incorporated at the rate of 1 inch of compost for every 3 inches of deficient topsoil.

The top of the completed sodbed should contain a minimum soil organic matter content of 5%. In areas where topsoil has not been stripped, and the soil organic content is low, compost may be placed, as required, to increase the soil organic matter content.

The top 3 inches of the sodbed should be prepared by tilling, and the surface cleared of any trash, debris, roots, branches, and stones or clods larger than 3/4 inch in diameter. Any low spots should be filled or leveled to avoid standing water. The fertilizer and any other soil amendments should be uniformly applied and incorporated into the top 1 1/2 inches of the soil by tilling or disking. Complete soil preparation by rolling or cultipacking to firm the soil. Avoid using heavy equipment on the area, particularly when the soil is wet, as this may cause excessive compaction and make it difficult for the sod to take root.

Newly graded areas may be severely compacted by the weight of heavy earth moving and construction equipment. Disking or tilling reduces compaction in the uppermost layer of the soil, providing an adequate growing bed for the sod; however the soil below this level may remain severely compacted. This compacted layer acts as an impermeable barrier, slowing or preventing the infiltration of water into the ground. Infiltration of precipitation reduces runoff and recharges groundwater supplies. Techniques for reducing ground compaction, such as deep tillage, should be investigated.

- 3. Installation Techniques:** Sod should be placed as soon as possible after the ground surface has been graded, to take advantage of the ground moisture, and installed within 36 hours of cutting. The soil should be slightly moist, but firm enough not to leave depressions if walked on. Install sod in a straight line at right angles to the direction of the slope, starting at the base of the area to be sodded and working uphill. Sodding operations should be planned so that sloped areas can be completely protected, from bottom to top, prior to halting operations for the day, or before significant precipitation is expected. The angled ends caused by the automatic sod-cutting machine must be matched correctly.

Figure 7E-25.01: Proper Sod Installation

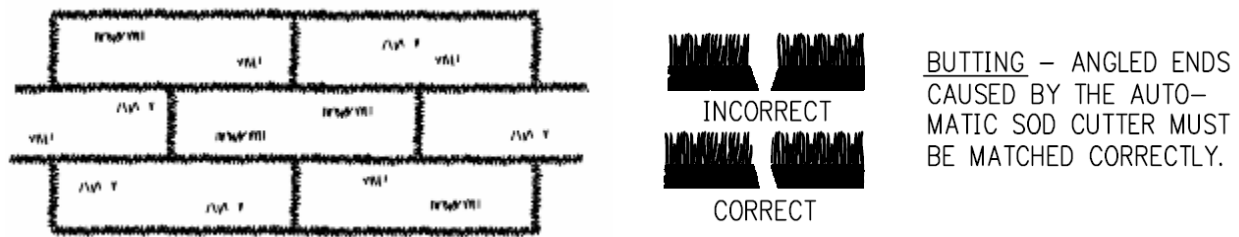

Source: Kansas City APWA, 2003

Place the strips together tightly so that no open joints are left between strips or between the ends of strips. Lateral joints shall be staggered in a brickwork-type pattern to promote uniform growth and strength. Sod should not be overlapped or stretched, and all joints should be butted tightly to prevent voids. Sod should be laid perpendicular to the flow of water on slopes and in waterways. The edges of the sod at the top of the slopes should be slightly tucked under. A layer of soil should be compacted over the edge to conduct surface water over and onto the top of the sod. Fill any spaces between the joints and all sod edges with at least 2 inches of topsoil.

Care shall be taken to prevent voids or over-exposure of the roots, which would cause drying. As sodding of defined areas is completed, sod shall be rolled or tamped to provide firm contact between roots and soil. Seam openings between the mats are a sign the turf is shrinking and that the sod requires more water. Gaps between edges or ends of sod mats should be filled with topsoil and rolled. If sod placement is delayed, it should be kept cool and moist. When placed on slopes steeper than 3:1, or in areas subject to concentrated flow, the sod should be anchored with pins, staples, or other approved methods at the ends and center, or every 3 to 4 feet for longer strips, to prevent movement. Sod should be kept moist until it is firmly rooted which typically takes a minimum of two weeks (see supplemental watering).

4. **Sod Properties:** Sod should be of high quality, which the genetic origin is known, free of noxious weeds, disease, and insect problems consisting of a 3/4 inch mat of vigorous turf. It should appear healthy and vigorous, and conform to the following specifications:
 - a. Sod should be live grass, machine cut at a uniform depth of 1/2 to 2 inches (excluding shoot growth and thatch).
 - b. Sod strips should be cut with smooth, clean edges and square ends to facilitate laying and fitting.
 - c. Sod should not be cut in excessively wet or dry weather.
 - d. Frozen sod should never be placed.
 - e. Sod should not be permitted to dry out.
 - f. Harvested sod pieces can vary from widths of 12 to 48 inches and lengths of 2 to 100 feet, but should be in sections strong enough to support their own weight and retain their size and shape when lifted by one end.

- g. As noted in the installation considerations, harvest, delivery, and installation of sod should take place within a period of 36 hours.
 - h. Sod should be moistened after it is unrolled, which helps to maintain its viability, and stored in the shade if possible, during installation.
5. **Supplemental Water:** After placement is complete, the sod should be irrigated to a depth sufficient that the underside of the sod mat and 4 inches of soil below sod is thoroughly wet. Irrigate at a rate that does not result in runoff. The moisture level can be checked by lifting a corner of a sod roll, and verifying that water is penetrating well into the subsoil.

As a rule of thumb, watering should be scheduled as follows:

- a. **First Week:** The sod soil should be kept moist at all times. During dry spells, the sod should be watered daily, or as often as necessary to maintain moist soil. The sod should be watered during the heat of the day to prevent wilting.
- b. **Second and Subsequent Weeks:** Water sod to maintain adequate moisture in the soil until the grass takes root. This can be determined by gently tugging on the sod. Resistance indicates that rooting has occurred.
- c. **Summer Installations (June through August):** Summer installations require high levels of attention to water application needs, as newly installed sod will dry out rapidly, suffering significant setback or total loss.

C. Application

The NPDES General Permit No. 2 requires that all disturbed areas, where no construction activities are scheduled for a period of 21 calendar days or more, be stabilized within 14 days of the final construction activity. Sodding is one way to meet this requirement.

D. Maintenance

The sodded area should be inspected daily for at least two weeks, or until the sod is established, to ensure that the moisture content is sufficient and that root establishment is proceeding. The sod should not be mowed regularly until it is well established, and the roots have knitted down. The turf should never be mowed shorter than 2 1/2 inches and no shorter than 3 inches during June, July, and August, in order to increase drought tolerance.

E. Time of Year

Sod availability is seasonal, although it can be laid in nearly all weather conditions. Sod laid during the middle of the summer will require significantly more maintenance and watering. If the ground is frozen, sod cannot be cut and should not be laid; however, if it is available, unfrozen, dormant sod can be laid on unfrozen ground, provided there is not a significant layer of snow.

Vegetative Filter Strip



<u>BENEFITS</u>			
	L	M	H
Flow Control	■	□	□
Erosion Control	■	□	□
Sediment Control	■	■	□
Runoff Reduction	■	□	□
Flow Diversion	□	□	□

Description: A filter strip is a natural system that uses plants to filter stormwater runoff. The vegetated filter strip (VFS) serves as a perimeter buffer zone and a last defense between an area needing protection, such as a street or water body (stream, wetland, lake, etc.), and the adjacent property. Its primary purpose is to remove sediment and other pollutants from runoff water by filtration, deposition, infiltration, absorption, and vegetative uptake.

A VFS relies on the use of vegetation to slow runoff velocities and filter out sediment and other pollutants from construction site runoff. There can be a significant reduction in runoff volume for smaller flows that infiltrate pervious soils while contained within the filter strip. Sheet flow must be maintained across the entire filter strip for it to maintain its effectiveness.

Typical Uses: As a sediment control practice, a VFS installed specifically during construction is typically used to prevent sediment from moving into/onto adjacent property. It is intended to keep downstream areas free of sediment.

Advantages:

- Natural measure to remove coarse sediment.
- Reasonably low construction costs.
- Filter strips are a low-maintenance practice, but maintenance increases as sediment volumes increase.
- May be able to utilize existing vegetation as a treatment device.
- Provides an aesthetically pleasing appearance.

Limitations:

- Are not intended to treat concentrated flow.
- The disturbed area draining to the vegetated strip should have slopes of 6% or less.
- Requires more land area than other sediment control practices.

Longevity: Permanent

SUDAS Specifications: Refer to [Section 9010 \(Seeding\)](#) or [9020 \(Sodding\)](#)

A. Description/Uses

Vegetative Filter Strips (VFS) are densely vegetated strips of land (typically installed with sod-forming grasses) with a uniform slope to maintain sheet flow, which are designed to treat runoff and remove pollutants through vegetative filtering and infiltration during the construction phase. A VFS is located along the length of the downslope edge of the entire disturbed area to treat the runoff.

A VFS relies on the use of vegetation to slow runoff velocities and filter out sediment and other pollutants from construction site runoff. There can be a significant reduction in runoff volume for smaller flows that infiltrate pervious soils while contained within the filter strip. To be effective, sheet flow must be maintained across the entire filter strip.

B. Design Considerations

Because of the large area required to provide adequate treatment, filter strips are generally used to treat small drainage areas (less than 5 acres). However, larger sites that have significant undisturbed vegetation or sufficient area for construction of a VFS may be well suited for accommodating a vegetated filter strip.

The size of the filter strip depends on the drainage area and the filter strip slope. Flow must enter the filter strip as sheet flow and spread out over the width of the strip. It is desirable to keep flow depth across the strip below a 1/2 inch in order to maintain sheet flow.

A level spreader may be required at the upstream end of the strip to dissipate concentrated flows and ensure sheet flow across the strip. Level spreaders or filter berms should be constructed perpendicular to the slope every 100 feet for slopes less than 5% and every 50 feet for slopes greater than 5% to prevent concentrated flows from forming.

It should be noted that existing vegetation along a channel or drainage way can be used as a VFS. By simply protecting this vegetation during construction, an inexpensive VFS may be created.

C. Application

There are three different approaches to determining the size of a filter strip:

1. Adjacent to the disturbed ground, a VFS with a minimum width of 25 feet is adequate for treating runoff from disturbed areas up to 125 feet in width. For larger disturbed areas, the width of the VFS should be increased by 1 foot for every 5 feet beyond the 125 foot limit.

Figure 7E-26.01: Vegetated Filter Strip Adjacent to Disturbed Area

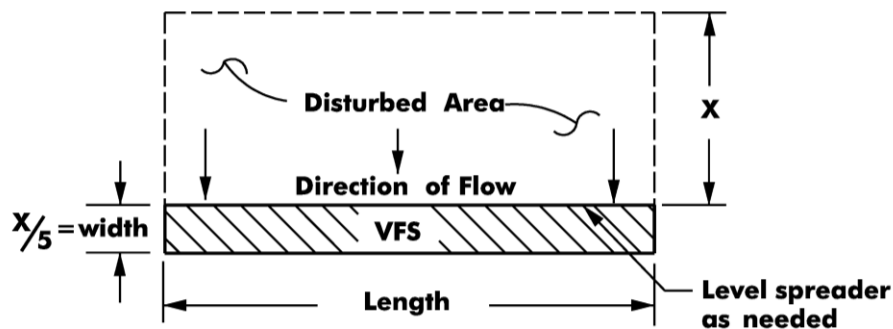

- When the VFS is not completely adjacent to the site, it should be sized to be a minimum of one-half the area of the disturbed ground (i.e. $\text{Length} \times \text{Width} = 1/2 \times \text{Disturbed Area}$). The width of the VFS should be sized according to Manning's equation (refer to [Chapter 2 - Stormwater](#), to limit the flow depth to a 1/2 inch or less (a minimum of width of 25 feet should be provided).

Figure 7E-26.02: Vegetated Filter Strip Downstream of Disturbed Ground

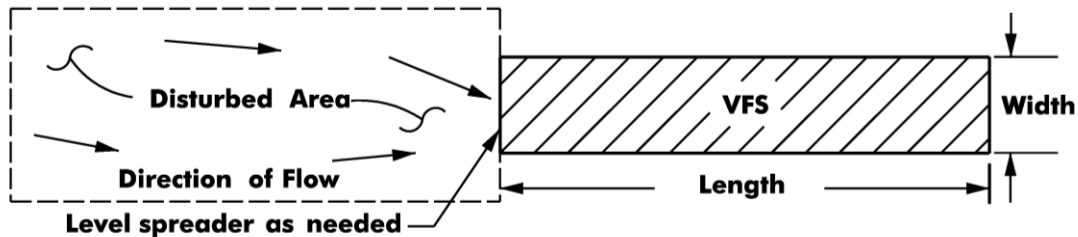

- The VFS may also be designed to provide a 20 minute travel time (contact time) for runoff. This level of contact time with the vegetation is able to achieve 85% removal of Total Suspended Solids (TSS) (US-EPA, 1980).

D. Maintenance

Vegetated filter strips should be protected from vehicular traffic and construction equipment. The stand of vegetation should be maintained at a height of 3 to 6 inches. Unwanted weeds, brush, and trees should be controlled.

Vegetated filter strips require regular inspection to ensure proper distribution of flows, examine for signs of rill formation, and check for and remove accumulated sediment.

Rock Chutes and Flumes



<u>BENEFITS</u>			
	L	M	H
Flow Control	██████████		
Erosion Control	██████████		
Sediment Control	□	□	□
Runoff Reduction	□	□	□
Flow Diversion	□	□	□

Description: Rock chutes and flumes are devices used to convey concentrated flows down an embankment or slope to a lower level without causing erosion.

Typical Uses: Commonly used as a permanent feature at the release point where runoff enters a ditch, stream, or lake. They are also used as a temporary measure to stabilize the inlet slope to a sediment trap or basin.

Advantages:

- Stabilizes slopes and areas where high flow volumes occur.
- Prevents further erosion at entrance to sediment removal devices, reducing the required cleanout frequency.

Limitations:

- May not be considered aesthetically pleasing for permanent installations.
- May be a relatively expensive measure for temporary structures.
- Requires careful construction practices.
- Difficult to maintain level, especially through freeze-thaw cycles.

Longevity: Permanent

SUDAS Specifications: Refer to [Section 9040, 2.09](#) and [3.13](#)

A. Description/Uses

Rock chutes are devices used to stabilize the inlet slopes to sediment traps, sediment basins, rivers, ponds, lakes, and other drainage structures. The chutes consist of a rock-lined channel constructed on a steep slope.

Proper construction of the rock chute is imperative to its performance. The chute must be carefully notched into the ground to the thickness of the rock, to ensure positive drainage into the chute from the edges. If drainage into the chute from the edges is not provided, runoff will flow along the top of the chute, creating the potential for scouring under the chute.

After constructing the chute to the appropriate cross-section, a layer of engineering fabric is usually placed to protect the underlying soils. Crushed stone of the size or weight specified is then placed over the fabric, creating a stable surface to transport large flows down steep grades.

B. Design Considerations

The design of a rock chute is dependent on several factors including: the steepness of the slope; the shape of the channel; the volume and velocity of the water; the size of the rip rap material; and the downstream tailwater.

In order to simplify the process of designing and sizing a rock chute, a spreadsheet has been developed by the Iowa Division of the National Resource Conservation Service (NRCS). This spreadsheet is available on the internet and may be accessed from the following address: <http://www.nrcs.usda.gov/wps/portal/nrcs/main/ia/technical/engineering/>.

For permanent structures, an articulated or modular block system may also be considered. These products may be more aesthetically pleasing than a rock chute. Many can be vegetated to hide or mask the underlying armoring. Design information for these products is available from their respective manufacturers.

Installation of a turf reinforcement mat (TRM) might also be considered as an alternative to a rock chute (see [Section 7E-18](#))

C. Application

Rock chutes should be considered at all locations where an elevation drop may create flow velocities that exceed the ability of the existing ground surface (bare or vegetated) to prevent erosion.

D. Maintenance

If designed and installed properly, maintenance of rock chutes is normally minimal. If the chute is left over a winter, it should be inspected in the spring to ensure that it is level. Any movement caused by freeze-thaw should be corrected.

Flocculents



<u>BENEFITS</u>			
	L	M	H
Flow Control	<input type="checkbox"/>	<input type="checkbox"/>	<input type="checkbox"/>
Erosion Control	<input type="checkbox"/>	<input type="checkbox"/>	<input type="checkbox"/>
Sediment Control			
Runoff Reduction	<input type="checkbox"/>	<input type="checkbox"/>	<input type="checkbox"/>
Flow Diversion	<input type="checkbox"/>	<input type="checkbox"/>	<input type="checkbox"/>

Description: Flocculents are natural materials or a class of chemicals that cause colloidal particles (clay) to coagulate. The coagulated particles group together to form flocs that will settle out of detained stormwater.

Typical Uses: Used in conjunction with sediment basins and sediment traps to remove suspended clay and fine silt particles from stormwater runoff prior to discharge.

Advantages:

- Ability to remove fine particles that would not settle out otherwise.
- Increases the percentage of fines removed during the detention period.
- May be used to remove suspended particles during dewatering operations.

Limitations:

- Requires specific dosing of the appropriate flocculent to achieve proper sedimentation.
- Flocculent must be thoroughly mixed with the stormwater.
- Flocculated particles must still be allowed to settle which takes time.
- Some flocculents are considered chemical pollutants. When these are used, the discharge must be carefully monitored to ensure that flocculent is adequately removed by settling.
- Flocculated material must be removed upon completion of the project for basins that are to be converted into permanent structures.

Longevity: Only effective on the runoff volume they are applied to; no long-term benefits

SUDAS Specifications: Typically, flocculents are only used in special circumstances and therefore have not been included in SUDAS Specifications

A. Description/Uses

Even with the proper sediment controls in place, suspended clay and loess particles are difficult to remove. Water ponded for days, or even weeks, can remain murky due to the suspension of these fine particles. Flocculents aid in removing these fine particles and may be a desirable treatment method for locations with clay or loess soils that are upstream of lakes, ponds, or other sensitive waterways.

B. Design Considerations

Fine soil particles, such as loess and clay particles, are difficult to remove with conventional settling techniques (basins, traps, etc.). The colloidal particles contain a negative electrostatic surface. Particles with like charges repel each other, preventing them from sticking together and settling out. This allows these small particles to remain in suspension indefinitely.

Coagulants are a class of chemicals that may be added to turbid stormwater to aid in the removal of suspended colloidal particles. Negatively-charged soil particles are attracted to the positively-charged coagulant particles. These particles stick together and form a larger, neutrally-charged particle called a floc. Since the colloidal particle forms a neutrally-charged floc, it no longer repels other particles, and can combine with other floc particles. The process of combining flocs into larger flocs that can be settled out of suspension is called flocculation. While the class of chemicals that ultimately cause the process of flocculation are technically called coagulants, the term flocculents has been adopted and is more widely used within the industry.

One flocculent that has been commonly used for stormwater applications is Polyacrylamide (PAM). Two versions of PAM are available, cationic and anionic. Only anionic PAM should be used, as cationic PAM is considered highly toxic. Anionic PAM has been used for many years in the water and wastewater industry and is considered safe for humans and aquatic life when used at the recommended rates.

Chitosan is another flocculent that is derived from the exoskeletons of crustaceans. It is generally considered safe for use in stormwater and water bodies.

A variety of other flocculent materials are available. Since trace amounts of flocculent will undoubtedly be discharged, the product used should be non-toxic and safe for both human and aquatic life and should not create Biochemical Oxygen Demand (BOD) problems in the downstream discharge waters.

Selection of an appropriate flocculent is highly dependent on the soil particle type and concentration. Analysis of a sample of the contaminated water is usually required to select the proper product and application rate. Manufacturers of these products will normally assist in this process.

C. Application

Several different methods of delivery are available for the application of flocculents to stormwater runoff. The most basic involves a solid form of the flocculent, either in block or pellet form, that is placed in a wire basket or mesh screen within the runoff as it flows into the sediment basin. The flowing water slowly dissolves the material, releasing flocculent into the basin.

More advanced methods involve equipment that will inject a liquid form of the flocculent into the runoff stream or storm sewer pipe at the desired rate.

Portable equipment that treats and filters the runoff is also available. Contaminated runoff is pumped

from a sediment basin, treated with a flocculent, and then passed through sand filters to remove the suspended solids. The treated water may then be discharged.

Regardless of the flocculent material or method used, the material should never be added directly to the sediment basin or any standing water, unless adequate agitation is provided. The flocculent product should be introduced well in advance of the sediment control structure to allow for adequate mixing before the runoff arrives in the structure.

Adequate facilities need to be provided to allow for the settlement of the flocculated particles. Normally, a properly designed sediment basin is sufficient for this application. The accumulated material should be removed and disposed of properly.

D. Maintenance

Sediment should be removed on a routine basis to ensure a volume to receive the sediment. Timing will be based on having ample storage volume to accommodate anticipated runoff. Retention time and sediment storage volume are critical.

E. Time of Year

The effectiveness of the flocculent can be affected by temperature. The manufacturer should account for this when providing specific product and dosing rate recommendations.

Flotation Silt Curtain



<u>BENEFITS</u>			
	L	M	H
Flow Control	<input type="checkbox"/>	<input type="checkbox"/>	<input type="checkbox"/>
Erosion Control	<input type="checkbox"/>	<input type="checkbox"/>	<input type="checkbox"/>
Sediment Control	<input checked="" type="checkbox"/>	<input type="checkbox"/>	<input type="checkbox"/>
Runoff Reduction	<input type="checkbox"/>	<input type="checkbox"/>	<input type="checkbox"/>
Flow Diversion	<input type="checkbox"/>	<input type="checkbox"/>	<input type="checkbox"/>

Description: A flotation silt curtain (also called a turbidity curtain) consists of a geosynthetic fabric that is suspended vertically in a body of water. The top of the curtain is attached to floats, and the bottom is weighted.

Typical Uses: Flotation silt curtains are used when construction occurs in a water body or along a stream bank or shoreline. Flotation silt curtains prevent sediment, which is stirred up during construction, from migrating out of the work area and into the rest of the water body.

Advantages:

- Allows for containment of sediment-laden water within a water body.
- Protects contained water from turbulence, allowing particles to fall out of suspension.

Limitations:

- Limited to use only in areas where other erosion and sediment control practices cannot be used.
- Cannot stop the flow of a significant amount of water.
- Must not be used to filter entire stream flow.
- Difficult to remove fine silt and clay particles.

Longevity: One construction season (do not leave in place during winter)

SUDAS Specifications: Typically, flotation silt curtains are only used in special circumstances and therefore have not been included in SUDAS Specifications

A. Description/Uses

A flotation silt curtain, also called a turbidity curtain, consists of a heavy geosynthetic fabric that is suspended vertically in a water body, with floats at the top, and weights at the bottom. The purpose of the curtain is to act as a divider, preventing sediment laden-water from migrating to the rest of the water body.

Flotation silt curtains are commonly used when construction is required near or within a water body, where other erosion and sediment control practices cannot be used. This may include dredging operations, stream bank improvements, bridge pier construction, etc.

B. Design Considerations

For ponds or other relatively still water bodies, which do not have significant inflow into the containment area, the flotation silt curtain consists of a relatively impermeable membrane that provides a barrier between clean water and sediment-laden water. The barrier creates a containment basin, in which sediment is trapped and allowed to fall out of suspension. Runoff into this type of curtain should be minimized, as the available volume is limited.

For situations that have moving water, such as lakes or streams, a provision must be made to allow water to flow through the curtain. This is normally accomplished by constructing part of the curtain from heavy filter fabric. The filter fabric allows water to pass through the curtain, maintaining equilibrium, but retaining sediment particles. While these curtains are designed to allow for some water movement, they do not have high flow-through rates, and should not be installed across a channel. When used in a stream, channel, or other body of moving water, the flotation silt curtains must be placed parallel to the direction of flow.

Unless the water body is subject to wind or wave actions, the curtain should extend the entire depth of the water, and rest on the bottom. The weighted bottom of the curtain needs to maintain contact with the bottom of the water body in order to keep sediment from flowing under the curtain. In order to do this, enough slack must be provided to allow the curtain to rise and fall as the depth of the water varies, without breaking contact with the bottom of the water body.

In situations where there is significant wind or wave action, the weighted end of the curtain should not extend to the bottom of the water body. Wind/wave action on the flotation system can cause movement of the lower end of the curtain, causing it to rub against the bottom, stirring up additional sediment. In these situations, a minimum 1 foot gap should be provided between the lower end of the curtain and the bottom of the water body. In addition, it is not practical to extend the curtain deeper than 10 or 12 feet. Deeper installations can be affected by the moving water, stressing the material, and causing the bottom of the curtain to be pushed around, billowing up toward the surface.

When determining the required length of the flotation silt curtain, an additional 10 to 20% should be included over the straight-line measurements. This allows for easier installation and reduces stresses caused by high winds and wave action.

Once the curtain has been positioned within the water body, the top is held in place by connecting it to anchors that are installed at regular intervals. The ends of the curtain (both upper and lower) should be extended to the shoreline, and anchored to a stable object, such as a tree.

C. Application

Flotation silt curtains are divided into three types, Type I, Type II, and Type III, based upon the flow conditions within the water body. The information provided here applies to minimal and moderate flow conditions, where the velocity of flow is 5 feet per second or less. For situations where the flow is greater than this, additional investigation is required, and a qualified manufacturer should be consulted.

The three types of silt curtains are differentiated by the strength and flow through rate of the fabric, and the strength of the connecting materials used:

1. Type I curtains are considered light-duty and are intended for areas where there is no current, and where the area is protected from wind and wave action.
2. Type II curtains can be used in areas with moderate running current (up to 3.5 fps), or where wind and water currents can affect the curtain.
3. Type III curtains are used in areas with considerable current (up to 5 fps), or where the curtain is subject to more severe wind and wave action.

D. Maintenance

A decision must be made on how to handle the accumulated sediment. Unless the accumulation is significant, consideration should be given to leaving this sediment in place. The process of removing the sediment can re-suspend the particles. Regardless of whether or not the accumulated sediment is removed, suspended sediment should always be allowed to settle for a minimum of 24 hours prior to removal of the silt curtain.

Once they are suspended in the water, clay and silt particles are difficult to remove by settling methods alone. For waters contaminated with clay or fine silts, the addition of a flocculent to the containment area may be considered prior to removal of the silt curtain. Care must be taken when selecting a flocculent as some are detrimental to water bodies and should not be used. See [Section 7E-6 - Wattles](#) for additional information on flocculents.

E. Time of Year

Sediment curtains should not be left in place during winter months, as ice can cause the curtain to rip or be torn from its shoreline supports.



Appendix

Before construction can begin on a site the following steps must be taken to be in compliance with the Iowa DNR General Permit No.2:

- A Stormwater Pollution Prevention Plan must be created for the site
- A Notice of Intent (NOI) must be completed by the operator of the construction site and this document along with public notices must be submitted to the Iowa DNR.
- A signed affidavit must be filed with the local Soil and Water Conservation District stating that the project will not exceed the soil loss limits stated.
- A Letter of Authorization is provided to the Operator of the construction site, upon approval of the NOI by Iowa DNR.
- SWPPP review and approval is required by MS-4 cities prior to construction.
- Necessary best management practices should be in place prior to construction.
- Construction can then begin.

Copies of the NPDES stormwater permitting guidance and application forms can be found on [Iowa DNR's website](#).

References

Applied Polymer Systems, Inc. Floc Log.

Available at: <http://www.siltstop.com/>. Accessed January 2006.

Bolander, Pete ; Yamada, Alan . *Dust Palliative Selection and Application Guide*.

Report No. 9977 1207. San Dimas Technology and Development Center. Department of Agriculture, Forest Service. San Dimas, CA. 1999

Available at: <http://www.fs.fed.us/eng/>. Accessed August 2005.

Chen, Y.H. & Cotton, G.K. *Design of Roadside Channels with Flexible Linings*.

Report No. FHWA-IP-87-7, HEC #15. Federal Highway Administration, Washington, DC. 1988.

Clackamas County Water Environment Services. *Erosion Prevention and Sediment Control Planning and Design Manual*. Clackamas, OR. 2000.

Available at: <http://www.clackamas.us/wes/>. Accessed July 2017.

Fifield, J. *Designing for Effective Sediment and Erosion Control on Construction Sites*. Forester Communications, Santa Barbara, CA. 2001.

Iowa Department of Natural Resources, Environmental Protection Division. *A Brief Guide to Developing Pollution Prevention Plans and Best Management Practices*. Iowa Department of Natural Resources, Des Moines, IA. 2003.

Iowa Department of Natural Resources. *Iowa Construction Site Erosion Control Manual*. Iowa Department of Natural Resources, Des Moines, IA. 2006.

Iowa Department of Natural Resources. *NPDES General Permit No. 2: Storm Water Discharge Associated with Industrial Activity for Construction Activities*. Iowa Department of Natural Resources, Des Moines, IA.

Iowa Department of Transportation, Office of Design. *Chapter 10: Roadside Development and Erosion Control, Design Manual*. Iowa Department of Transportation, Ames, IA. 2004.

Iowa NRCS - USDA Natural Resources Conservation Service. *Conservation Strategies for Growing Communities*. 2004.

Available at: http://www.nrcs.usda.gov/Internet/FSE_DOCUMENTS/nrcs142p2_005500.pdf. Accessed October 2015.

Jerico Services, Inc. Dust Control.

Available at: <http://www.jericoservices.com>. Accessed August 2005.

Kansas City Metropolitan Chapter American Public Works Association. *Section 5100: Site Work and Erosion and Sediment Control. Kansas City Metro Chapter APWA Standard Specifications, Design Criteria, and Standard Drawings*. 2003.

Available at:

<http://kcmetro.apwa.net/content/chapters/kcmetro.apwa.net/file/Specifications/APWA5100.pdf>.

Accessed October 2015.

- Lancaster, T. & Austin, D. *Classifying Rolled Erosion-Control Products: A Current Perspective*. Erosion Control Technology Council. St. Paul, MN. 2004.
Available at: <http://www.ectc.org/>. Accessed December 2004.
- McCaulay, A & Jones, C. *Soil & Water Management Module 3: Managing for Soil Erosion*. Montana State University Extension Service. Bozeman, Montana. 2005.
- Mississippi State University. *NRCS Planning and Design Manual*.
James Worth Bagley College of Engineering. Mississippi State University. Starkville, MS.
Available at: <http://www.abe.msstate.edu/>. Accessed January 2006.
- Morgan, Ryan J., Vernon R. Schaefer, and Radhey S. Sharma. *Determination and Evaluation of Alternative Methods for Managing and Controlling Highway-Related Dust*. IHRB Project TR-506. Iowa Highway Research Board and Iowa Department of Transportation, Ames, Iowa. 2005.
- North American Green. Products & Design Software.
Available at: <http://www.nagreen.com>. Accessed December 2004.
- Penn State University. *Proper Sizing of the Control Orifice for the Faircloth Skimmer*.
Available at: <http://pubs.cas.psu.edu/freepubs/pdfs/F252.pdf>. Accessed October 20, 2004.
- Propex Geotextile Systems.
Available at: <http://propexglobal.com/>. Accessed July 2017.
- Roberts, B. *Best Management Practices for Erosion and Sediment Control*. Report No. FHWA-FLP-94-005. Federal Highway Administration, Washington, DC . 1995.
- ScourStop. Resources.
Available at: <https://hanesgeo.com/Catalog/Product?id=2879>. Accessed July 2017.
- Smoot, J. *Soil Erosion Prevention and Sediment Control*. The University of Tennessee, Knoxville. Knoxville, TN. 1999.
- Soil-Tek. Project Photos.
Available at: <http://www.soil-tek.com/>. Accessed January 2006.
- Stillwater Outdoor Hydraulic Laboratory. *Handbook of Channel Design for Soil and Water Conservation*. Report No. SCS-TP-61. USDA Soil Conservation Service, Washington D.C. 1966.
- The Umstead Coalition. News.
Available at www.umsteadcoalition.org. Accessed September 2005.
- U.S. Army Corps of Engineers. *Engineering and Design - Handbook for the Preparation of Storm Water Pollution Prevention Plans for Construction Activities*. Publication No. EP 1110-1-16.
U.S. Army Corps of Engineers. Washington, D.C. 1997.
Available at: <http://www.publications.usace.army.mil/USACEPublications/EngineerPamphlets.aspx>.
Accessed October 2015.
- Photo courtesy of Jennifer Welch, Urban Resource and Borderland Alliance, (URBAN). Ankeny, Iowa.

USDA Natural Resources Conservation Service. *Engineering Field Manual: Chapter 7: Grassed Waterways*. USDA Natural Resources Conservation Service, Washington D.C. 1986.

USDA Natural Resources Conservation Service. Photo Gallery.
Available at: <http://photogallery.nrcs.usda.gov/res/sites/photogallery/>. Accessed October 29, 2015.

U.S. Environmental Protection Agency. National Pollutant Discharge Elimination System (NPDES).
Available at: <https://www.epa.gov/npdes>. Accessed July 2017.

Virginia Department of Conservation and Recreation. *Erosion & Sediment Control Technical Bulletin #2: Application of Anionic Polyacrylamide for Soil Stabilization and Stormwater Management*. Virginia DCR, Richmond VA. 2002.

Virginia Department of Conservation and Recreation, Division of Water and Soil Conservation. *Virginia Stormwater Management Handbook, Volume I*. Virginia DCR, Richmond VA. 1999.

