

Temporary Sediment Basin



Source: Texas Erosion Supply

BENEFITS			
	L	M	H
Flow Control	■	■	■
Erosion Control	□	□	□
Sediment Control	■	■	■
Runoff Reduction	■	□	□
Flow Diversion	□	□	□

Commented [SK2R1]: Added language to the general "Design Considerations" section regarding stabilization of the basin side slopes with vegetation and possible flow control.

Commented [SK3]: Would prefer a "local" photo

Commented [SK4]: Need a new photo that shows a "stabilized" sediment basin.

Description: Sediment basins, like sediment traps, are temporary structures that are used to detain sediment-laden runoff long enough to allow a majority of sediment to settle out. Sediment basins are larger than sediment traps, serving drainage areas between 5 and 100 acres.

Sediment basins use a release structure to control the discharge, and normally have an emergency spillway to release the flow from larger storms. If properly planned, the basins may also serve as permanent stormwater management facilities, such as detention basins or permanent sediment removal structures.

Typical Uses: Used below disturbed areas where the contributing drainage area is greater than 5 acres. Basins require significant space and the appropriate topography for construction.

Advantages:

- Can greatly improve the quality of runoff being released from a site by removing suspended sediment on a large-scale basis.
- May be designed as a permanent structure to provide future detention, or for long-term water quality enhancement.

Limitations:

- Large in both area and volume.
- Use is somewhat dependent on the topography of the land.
- Must be carefully designed to account for large storm events.
- Not to be located within live streams.
- May require protective fencing.

Longevity: 18 months; may be converted to a permanent feature

SUDAS Specifications: Refer to [Sections 9040, 2.11](#) and [3.15](#)

A. Description/Uses

Sediment basins, like sediment traps, are temporary structures used to detain runoff so sediment will settle before it is released. Sediment basins are much larger than sediment traps, serving drainage areas up to 100 acres. If properly planned and designed, sediment basins can be converted to permanent stormwater management facilities upon completion of construction.

B. Design Considerations

Adequate storage volume is critical to the performance of the basin. Sediment basins that are undersized will perform at much lower removal efficiency rates. Sediment basin volumes and dimensions should be sized according to the criteria in [Section 7D-1](#).

Proper erosion controls need to be implemented within the sediment basin itself to limit erosion of the side slopes which can contribute to the need for increased clean out frequency. The primary method of erosion control within a sediment basin should be to provide vegetative cover over the side slopes. Depending on how water enters the basin and the side slopes of the basin, additional flow controls such as filter socks may also be necessary. It is not necessary to stabilize the collected sediment at the bottom of the basin while it is actively in service as it is recognized that this material will need to be removed.

A sediment basin consists of several components for releasing flows: a principal spillway, a dewatering device, and an emergency spillway. The principal spillway is a structure designed to which passes a given design storm. It also contains a de-watering device that slowly releases the water contained in the temporary dry storage. An emergency spillway may also be provided to safely pass storms larger than the design storm.

- 1. Principal Spillway:** The principal spillway consists of a vertical riser pipe connected at the base to a horizontal outlet pipe. The outlet pipe carries water through the embankment and discharges beyond the downstream toe of the embankment.

The first step in designing a principal spillway is to set the overflow elevation of the riser pipe. The top of the riser should be set at an elevation corresponding to a storage volume of 3,600 cubic feet per acre of disturbed ground. When an emergency spillway is provided, this elevation should be a minimum of 1 foot below the crest of the emergency spillway. If no emergency spillway is used, the top of the riser should be set at least 3 feet below the top of the embankment.

The next step is to determine the size of the riser and outlet pipes required. These pipes are sized to carry the peak inflow, Q_p , for the design storm. If an emergency spillway will be included, the principal spillway should be designed to handle the peak inflow for a ~~2-year~~ 2-year, 24-hour storm, without exceeding the elevation of the emergency spillway. If an emergency spillway is not included, the principal spillway must be designed to pass the 25-year storm, with at least 2 feet of clearance between the high-water elevation and the top of the embankment. Peak inflow flow rates should be determined according to the methods described in [Chapter 2 - Stormwater](#). The peak rate should account for the lack of vegetation and high runoff potential that is likely to occur during construction.

The riser size can be determined using the following equations. The flow through the riser should be checked for both weir and orifice flow. The equation, which yields the lowest flow for a given head, is the controlling situation.

$$\begin{array}{ll} \text{Weir Flow} & \text{Orifice Flow} \\ Q = 10.5 \times d \times h^{\frac{3}{2}} & Q = 0.6 \times A \times \sqrt{2gh} \end{array} \quad \text{Equations 7E-12.01 and 7E-12.02}$$

Where:

- Q = Inlet capacity of the riser, cfs
 d = Riser diameter, ft
 h = Allowable head above the top of riser, ft
 A = Open area of the orifice, ft²
 g = Acceleration of gravity, (32.2 ft/s²)

The allowable head is measured from the top of the riser to the crest of the emergency spillway or ~~to~~ the crest of the embankment if no emergency spillway is provided. Refer to Figures 9040.113 and 9040.114 in the SUDAS Specifications.

2. **Outlet Barrel:** The size of the outlet barrel is a function of its length and the total head acting on the barrel. This head is the difference in elevation of the centerline of the outlet of the barrel and the maximum elevation of the water (design high water). The size of the outlet barrel can be determined using [Chapter 2 - Stormwater](#) for culvert design.
3. **Anti-vortex Device:** An anti-vortex device should be installed on top of the riser section to improve the flow characteristics of water into the principal spillway, and prevent floating debris from blocking the spillway.

There are numerous ways to ~~provide protection for~~ concrete pipe including various hoods, grates, and rebar configurations that are part of the project-specific design, and will frequently be part of a permanent structure.

The design information provided in the following detail and table are for corrugated metal riser pipes.

The riser pipe needs to be firmly attached to a base that has sufficient weight to prevent flotation of the riser. The weight of the base should be designed to be at least 1.25 times greater ~~that than~~ the buoyant forces acting on the riser at the design high water elevation.

A base typically consists of a poured concrete footing with embedded anchors to attach to the riser pipe to anchor it in place.

Refer to Figure 9040.116 in the SUDAS Specifications.

4. **Dewatering Device:** The purpose of the dewatering device is to release the impounded runoff in the dry storage volume of the basin over an extended period ~~of time~~. This slow dewatering process detains the heavily sediment-laden runoff in the basin for an extended time, allowing sediment to settle out. The dewatering device should be designed to draw down the runoff in the basin from the crest of the riser to the wet pool elevation over ~~a period of~~ at least 6 hours.

One common method of dewatering a sediment basin is to perforate the riser section to achieve the desired draw-down of the dry storage volume. Riser pipes with customized perforations to meet individual project requirements can be easily fabricated from a section of corrugated metal pipe. The contractor or supplier can drill holes of the size, quantity, and configuration specified on the plans. The lower row of perforations should be located at the permanent pool elevation (top of the wet storage volume). The upper row should be located a minimum of 3 inches from the top of the pipe (principal spillway elevation).

Commented [SK5]: Deleted the sediment basin, anti-vortex, dewatering, and anti-seep collar figures. These are available in the specifications – it seems redundant to include here as well.

Added references (which can be hyperlinked)

Dewatering device design begins by determining the average flow rate for a ~~6-6~~ hour drawdown time. Once the average discharge is known, the number and size of perforations required can be determined. To calculate the area of the perforations, a single rectangular orifice that extends from the wet pool elevation to the proposed elevation of the top row of holes (a minimum of 3 inches below the principal spillway) is assumed.

Next, the average head acting on the rectangular orifice as the basin is dewatered is determined. This average head is approximated by the following equation:

$$h_a = \frac{(h_p - h_c)}{2} \quad \text{Equation 7E-12.03}$$

Where:

- h_a = Average head during dewatering
- h_p = Maximum head (between the wet pool and principal spillway)
- h_c = Distance between the wet pool elevation and the centroid of the orifice, ft

Figure 7E-12.015: Theoretical Discharge Orifice for Design of Perforated Risers

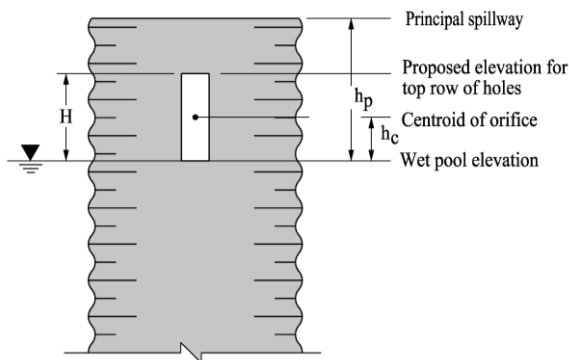

Once the average head is known, the area of the rectangular orifice is sized according to Equation 7E-12.04 to provide the average flow rate for the ~~6-hour~~ ~~6-hour~~ drawdown. Providing evenly spaced perforations that have a combined open area equal to that of the calculated rectangular orifice, will provide the desired discharge rate for a ~~6-hour~~ ~~6-hour~~ drawdown.

$$A = \frac{Q_a}{0.6 \times (2g \times h_a)^{1/2}} \quad \text{Equation 7E-12.04}$$

Where:

- A = Total area of the orifices, sf
- h_a = Average head acting on the orifice (Equation 7E-12.03)
- Q_a = Average flow rate required for 6-hour drawdown, cfs
- Q = S/21,600 sec. (~~6-6~~ hour drawdown only)
- S = Dry storage volume required, cf

The number and diameter of the holes ~~is-are~~ variable. The diameter selected should be a minimum of 1 inch to minimize clogging, and should be a multiple of 1/4 of an inch. The perforation configuration should consist of a minimum of three horizontal rows and two vertical

Field Code Changed

columns of evenly spaced perforations. Selecting a combination of hole diameter and number of holes is a trial and error process. Once the configuration is determined, the required information should be specified on the plans.

An alternative to the traditional riser is to provide a skimmer device that floats on the surface of the water in the basin. The skimmer is made of a straight section of PVC pipe equipped with a float and attached with a flexible coupling to an outlet at the base of the riser. Because the skimmer floats, it rises and falls with the level of the water in the basin and drains only the cleanest top layer of runoff. Sediment removal rates from basins equipped with skimmers ~~have been shown to be~~ significantly more effective than with a perforated riser or orifice.

Depending on the elevation of the outlet, the skimmer device may need to be supported to prevent the device from drawing the basin down below the wet storage elevation. This can be accomplished utilizing a pile of riprap or a simply constructed stand placed on the bottom of the basin and secured against movement and flotation.

Skimming devices are normally proprietary. Discharge information should be obtained from the manufacturer.

Figure 7E-12.062: Example Skimmer for Drawdown of Wet Storage

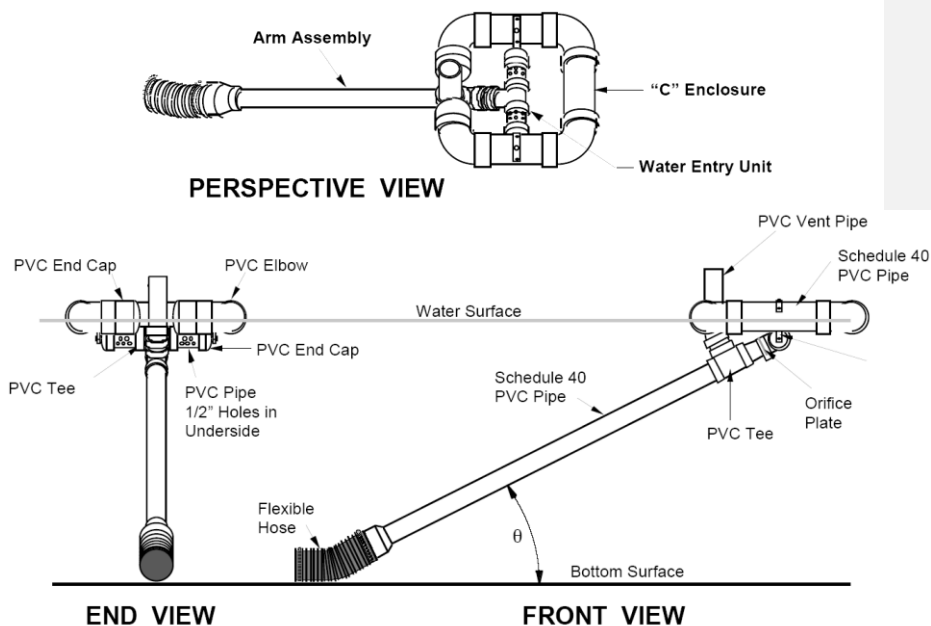

Source: Penn State University

- Emergency Spillway:** An emergency spillway acts as an overflow device for a sediment basin by safely passing the large, less frequent storms through the basin without damage to the embankment. It also acts in case of an emergency such as excessive sedimentation or damage to the riser that prevents flow through the principal spillway. The emergency spillway should

consist of an open channel constructed adjacent to the embankment over undisturbed material, not fill. This channel should be stabilized with matting, seeding, or sodding.

Where conditions will not allow the construction of an emergency spillway on undisturbed material, the spillway may be constructed on top of the embankment and protected with non-erodible material such as erosion stone.

An evaluation of the site and downstream conditions must be made to determine the feasibility of, and justification for, the incorporation of an emergency spillway. In some cases, the site topography does not allow a spillway to be constructed in undisturbed material, and the temporary nature of the facility may not warrant the cost of disturbing more acreage to construct and armor an emergency spillway. The principal spillway should then be sized to convey a ~~25~~ 25-year storm event, providing 2 feet of freeboard between the design high water elevation and the top of the embankment. If the facility is designed to be permanent, the added expense of constructing and armoring an emergency spillway may be justified.

When an emergency spillway is required, it should be designed to safely pass the ~~25-25~~ 25-25-year design storm with a minimum of one-foot clearance between the high water elevation and the top of the basin embankment. Since the principal spillway is only designed to carry the ~~2-2~~ 2-2-year event, the emergency spillway must carry the remainder of the ~~25-25~~ 25-25-year event.

$$Q_e = Q_{25} - Q_p$$

Equation 7E-12.05

Where:

Q_e = Required emergency spillway capacity, cfs

Q_{25} = 25-year, ~~24-24~~ 24-24-hour peak flow, cfs

Q_p = Principal spillway capacity at high water elevation, cfs

Based upon the flow requirements, Table 7E-12.01 can be used to determine the minimum width of the emergency spillway (b), the minimum slope of the exit channel (S), and the minimum length of the existing channel (X).

A control section at least 20 feet in length should be provided ~~in order~~ to determine the hydraulic characteristics of the spillway, according to Table 7E-12.01. The control section should be a level portion of the spillway channel at the highest elevation in the channel. If the length and slope of the exit channel indicated in Table 7E-12.01 cannot be provided, alternative methods of evaluating the spillway must be conducted.

Figure 7E-12.073: Typical Sediment Basin Emergency Spillway

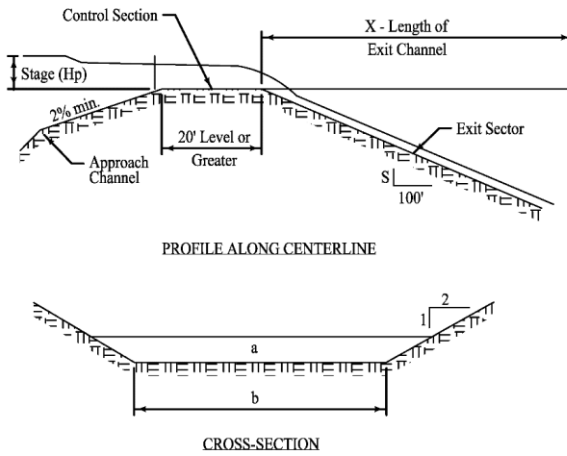
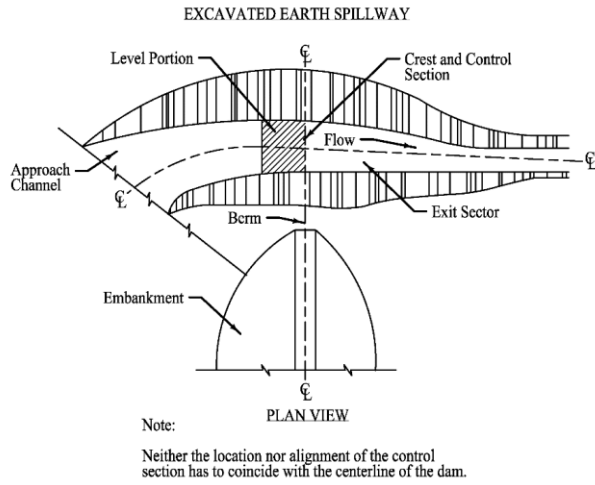

Source: Roberts, 1995

Table 7E-12.02: Design Data for Earthen Emergency Spillways

Stage (H _p) in feet	Spillway Variables	Bottom Width (b) in feet																
		8	10	12	14	16	18	20	22	24	26	28	30	32	34	36	38	40
0.5	Q	6	7	8	10	11	13	14	15	17	18	20	21	22	24	25	27	28
	V	2.7	2.7	2.7	2.7	2.7	2.7	2.7	2.7	2.7	2.7	2.7	2.7	2.7	2.7	2.7	2.7	2.7
	S	3.9	3.9	3.9	3.8	3.8	3.8	3.8	3.8	3.8	3.8	3.8	3.8	3.8	3.8	3.8	3.8	3.8
	X	32	33	33	33	33	33	33	33	33	33	33	33	33	33	33	33	33
0.6	Q	8	10	12	14	16	18	20	22	24	26	28	30	32	34	35	37	39
	V	3	3	3	3	3	3	3	3	3	3	3	3	3	3	3	3	3
	S	3.7	3.7	3.7	3.7	3.6	3.7	3.6	3.6	3.6	3.6	3.6	3.6	3.6	3.6	3.6	3.6	3.6
	X	36	36	36	36	36	36	37	37	37	37	37	37	37	37	37	37	37
0.7	Q	11	13	16	18	2	23	25	28	30	33	35	38	41	43	44	46	48
	V	3.2	3.2	3.3	3.3	3.3	3.3	3.3	3.3	3.3	3.3	3.3	3.3	3.3	3.3	3.3	3.3	3.3
	S	3.5	3.5	3.4	3.4	3.4	3.4	3.4	3.4	3.4	3.4	3.4	3.4	3.4	3.4	3.4	3.4	3.4
	X	39	40	40	40	41	41	41	41	41	41	41	41	41	41	41	41	4
0.8	Q	13	16	19	22	26	29	32	35	38	42	45	46	48	51	54	57	60
	V	3.5	3.5	3.5	3.6	3.6	3.6	3.6	3.6	3.6	3.6	3.6	3.6	3.6	3.6	3.6	3.6	3.6
	S	3.3	3.3	3.3	3.2	3.2	3.2	3.2	3.2	3.2	3.2	3.2	3.2	3.2	3.2	3.2	3.2	3.2
	X	44	44	44	44	45	45	45	45	45	45	45	45	45	45	45	45	45
0.9	Q	17	20	24	28	32	35	39	43	47	51	53	57	60	61	68	71	75
	V	3.7	3.8	3.8	3.8	3.8	3.8	3.8	3.8	3.8	3.8	3.8	3.8	3.8	3.8	3.8	3.8	3.8
	S	3.2	3.1	3.1	3.1	3.1	3.1	3.1	3.1	3.1	3.1	3.1	3.1	3.1	3.1	3.1	3.1	3.1
	X	47	47	48	48	48	48	48	48	48	48	49	49	49	49	49	49	49
1.0	Q	20	24	29	33	38	42	47	51	56	61	63	68	72	77	81	86	90
	V	4	4	4	4	4	4	4	4	4	4	4	4	4	4	4	4	4
	S	3.1	3	3	3	3	3	3	3	3	3	3	3	3	3	3	3	3
	X	51	51	51	51	52	52	52	52	52	52	52	52	52	52	52	52	52
1.1	Q	23	28	34	39	44	49	54	60	65	70	74	79	84	89	95	100	105
	V	4.2	4.2	4.2	4.3	4.3	4.3	4.3	4.3	4.3	4.3	4.3	4.3	4.3	4.3	4.3	4.3	4.3
	S	2.9	2.9	2.9	2.9	2.9	2.9	2.9	2.9	2.9	2.8	2.8	2.8	2.8	2.8	2.8	2.8	2.8
	X	55	55	55	55	55	55	55	56	56	56	56	56	56	56	56	56	56
1.2	Q	28	33	40	45	51	58	64	69	76	80	86	92	98	104	110	116	122
	V	4.4	4.4	4.4	4.4	4.4	4.5	4.5	4.5	4.5	4.5	4.5	4.5	4.5	4.5	4.5	4.5	4.5
	S	2.9	2.9	2.8	2.8	2.8	2.8	2.8	2.8	2.8	2.8	2.8	2.8	2.8	2.8	2.8	2.8	2.8
	X	58	58	59	59	59	59	59	59	60	60	60	60	60	60	60	60	60
1.3	Q	32	38	46	53	58	65	73	80	86	91	99	106	112	119	125	133	140
	V	4.5	4.6	4.6	4.6	4.6	4.6	4.7	4.7	4.7	4.7	4.7	4.7	4.7	4.7	4.7	4.7	4.7
	S	2.8	2.8	2.8	2.7	2.7	2.7	2.7	2.7	2.7	2.7	2.7	2.7	2.7	2.7	2.7	2.7	2.7
	X	62	62	62	63	63	63	63	63	63	63	63	64	64	64	64	64	64
1.4	Q	37	44	51	59	66	74	82	90	96	103	111	119	127	134	142	150	158
	V	4.5	4.8	4.8	4.8	4.8	4.8	4.8	4.8	4.8	4.9	4.9	4.9	4.9	4.9	4.9	4.9	4.9
	S	2.8	2.7	2.7	2.7	2.7	2.7	2.7	2.6	2.6	2.6	2.6	2.6	2.6	2.6	2.6	2.6	2.6
	X	65	66	66	66	66	67	67	67	67	67	68	68	68	68	68	68	68
1.5	Q	41	50	58	66	75	85	92	101	108	116	125	133	142	150	160	169	178
	V	4.8	4.9	4.9	5	5	5	5	5	5	5	5	5	5	5	5.1	5.1	5.1
	S	2.7	2.7	2.6	2.6	2.6	2.6	2.6	2.6	2.6	2.6	2.6	2.6	2.6	2.6	2.5	2.5	2.5
	X	69	69	70	70	71	71	71	71	71	71	71	72	72	72	72	72	72
1.6	Q	46	56	65	75	84	94	104	112	122	132	142	149	158	168	178	187	197
	V	5	5.1	5.1	5.1	5.1	5.2	5.2	5.2	5.2	5.2	5.2	5.2	5.2	5.2	5.2	5.2	5.2
	S	2.6	2.6	2.6	2.6	2.5	2.5	2.5	2.5	2.5	2.5	2.5	2.5	2.5	2.5	2.5	2.5	2.5
	X	72	74	74	75	75	76	76	76	76	76	76	76	76	76	76	76	76
1.7	Q	52	62	72	83	94	105	115	126	135	145	156	167	175	187	196	206	217
	V	5.2	5.2	5.2	5.3	5.3	5.3	5.3	5.4	5.4	5.4	5.4	5.4	5.4	5.4	5.4	5.4	5.4
	S	2.6	2.6	2.5	2.5	2.5	2.5	2.5	2.5	2.5	2.5	2.5	2.5	2.5	2.5	2.5	2.5	2.5
	X	76	78	79	80	80	80	80	80	80	80	80	80	80	80	80	80	80
1.8	Q	58	69	81	93	104	116	127	138	150	160	171	182	194	204	214	226	233
	V	5.3	5.4	5.4	5.5	5.5	5.5	5.5	5.5	5.5	5.5	5.6	5.6	5.6	5.6	5.6	5.6	5.6
	S	2.5	2.5	2.5	2.5	2.4	2.4	2.4	2.4	2.4	2.4	2.4	2.4	2.4	2.4	2.4	2.4	2.4
	X	80	82	83	84	84	84	84	84	84	84	84	84	84	84	84	84	84
1.9	Q	64	76	88	102	114	127	140	152	164	175	188	201	213	225	235	246	260
	V	5.5	5.5	5.5	5.6	5.6	5.6	5.7	5.7	5.7	5.7	5.7	5.7	5.7	5.7	5.7	5.7	5.7
	S	2.5	2.5	2.5	2.4	2.4	2.4	2.4	2.4	2.4	2.4	2.4	2.4	2.4	2.4	2.4	2.4	2.4
	X	84	85	86	87	88	88	88	88	88	88	88	88	88	88	88	88	88
2.0	Q	71	83	97	111	125	138	153	164	178	193	204	218	232	245	256	269	283
	V	5.6	5.7	5.7	5.7	5.8	5.8	5.8	5.8	5.8	5.8	5.8	5.9	5.9	5.9	5.9	5.9	5.9
	S	2.5	2.4	2.4	2.4	2.4	2.4	2.4	2.4	2.3	2.3	2.3	2.3	2.3	2.3	2.3	2.3	2.3
	X	88	90	91	91	91	91	91	91	92	92	92	92	92	92	92	92	92

Data to the right of the heavy vertical lines should be used with caution, as the resulting sections will be either poorly proportioned, or have velocities in excess of 6 feet per second

Q=Spillway Capacity, cfs
 S=Minimum downstream embankment slope, %
 V=Velocity, fps
 X=Minimum length of the exit channel, ft

Source: Roberts, 1995

In addition to checking the capacity of the spillway, the discharge velocity should also be considered. The allowable velocity for vegetated channels or channels lined with a turf reinforcement mat should be carefully analyzed. See [Section 7E-23](#) and [7E-18](#) for information on permissible velocities. For non-erodible linings such as concrete or rip rap, design velocities may be increased.

- 65. Anti-seep Collars:** Anti-seep collars help prevent water from flowing along the interface between the outlet barrel and the embankment. This movement of water can, over time, destabilize the embankment, causing it to wash out or burst.

Anti-seep collars are not ~~normally-typically~~ required for ~~temporary~~ sediment basins. However, when the height of the embankment exceeds 10 feet, or the embankment material has a low silt-clay content, anti-seep collars should be used.

~~For structures that are to become permanent wet ponds, the use of a chimney drain or filter diaphragm is recommended in place of an anti-seep collar. A filter diaphragm consists of a layer of porous material running perpendicular to the outlet barrel which intercepts and controls water movement and fines migration within the embankment. Refer to the NRCS National Engineering Handbook, Part 628, Chapter 45 for design guidance and material selection for chimney drains and filter diaphragms. Anti-seep collars should be used on all structures that may be converted to permanent features.~~

The first step in designing anti-seep collars is to determine the length of the barrel within the saturated zone. The length of the saturated zone is determined ~~with-by~~ the following:

$$L_s = Y(Z + 4) \left(1 + \frac{S}{0.25 - S} \right) \quad \text{Equation 7E-12.06}$$

Where:

- L_s = Length of the barrel within ~~the~~ saturated zone, ft
- Y = Depth of water at principal spillway crest, ft
- Z = Slope of ~~the~~ upstream face of ~~the~~ embankment, Z ft H: 1 ft V.
- S = Slope of the barrel in ft per ft

An increase in the seepage length along the barrel of 10% should be provided. Determine the length required to achieve this by multiplying L_s by 10% ($0.10L_s$). This increase in length represents the total collar projection. This can be provided for by one or multiple collars.

Choose a collar size that is at least 4 feet larger than the barrel diameter (2 feet in all directions). Calculate the collar projection by subtracting the pipe diameter from the collar size. Then determine the number of collars required by dividing the seepage length increase ($0.10L_s$) by the collar projection. To reduce the number of collars required, the collar size can be increased. Alternatively, providing more collars can decrease the collar size.

Collars should be placed at a maximum spacing of 14 times the minimum projection above the pipe, and a minimum spacing of 5 times the minimum projection. All collars should be located within the saturated zone. If spacing will not allow this, at least one collar should be located within the saturated zone.

~~Alternative methods of controlling seepage, such as a filter diaphragm may also be acceptable.~~

7. Enhanced Sediment Capture: As discussed above, sediment removal is achieved by providing time for sediment to settle out before the flow reaches the outlet. The design approach assumes flow through the basin is uniform; however, currents within the basin can develop which allow for short-circuiting of the flow path from the basin inlet directly to the outlet.

Figure 7E-12.04: Flow in Sediment Basin/Trap Short-Circuiting During Peak Runoff

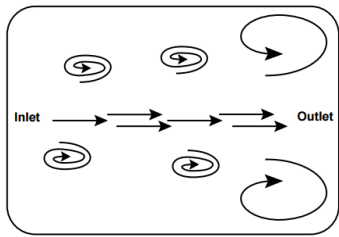

Source: NC State Extension

Commented [SK6]: OK to use "borrowed" figures, or should we re-create our own for the final version?

a. **Solid Baffles:** A simple way to mitigate short-circuiting and lengthen the flow path within the sediment basin is by installing solid baffles. Silt fence, being inexpensive and readily available on most construction sites, can be constructed in a series of rows perpendicular to the flow. A notch or weir at alternating ends of each row, force flow along a back and forth pattern, increasing the flow length. Solid baffles should be designed according to the following guidelines:

- The weir should be sized to accommodate the anticipated flows for the 2-year storm. For a 1-foot-deep weir, the width of the weir in feet should equal the flow rate in cfs divided by 3.
- The weirs should be placed on opposite sides of each other, but not too close to the basin's perimeter to keep the flow from eroding the basin's sides.
- The first bay should be easily accessible for maintenance as most of the sediment will accumulate in this area.

Commented [SK7]: Develop specification figure for solid baffles?

Figure 7E-12.05: Solid Baffles to Lengthen Flow Path

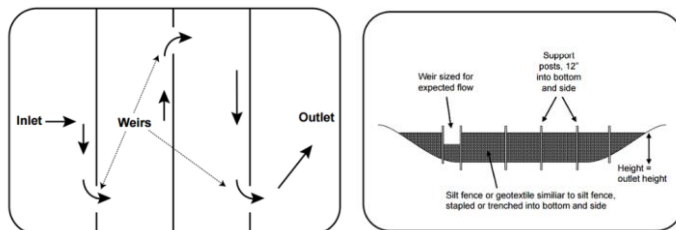

Source: NC State Extension

b. **Porous Baffles:** Another effective method to improve a basin's capture efficiency is to spread the flow uniformly across the width of the basin. One way to accomplish this is with a porous baffle. Porous baffles are installed perpendicular to the flow like solid baffles but without the weir. The porous nature of the baffle breaks up concentrated flows to prevent

short circuiting while developing uniform flow through the baffle. This maximizes the cross-sectional flow area through the basin, minimizing flow velocity. This combination increases sediment deposition and makes porous baffles even more effective than solid baffles.

Figure 7E-12.06: Porous Baffles Develop Uniform Flow

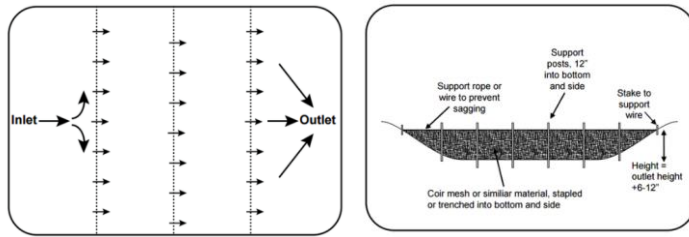

Source: NC State Extension

Porous baffles can be constructed from TRM or RECP blankets constructed of coir or wood excelsior. These blankets should be attached to steel posts and firmly anchored. The top of the blankets can be secured to a rope or wire stretched across the installation if they begin to sag.

- 78. Safety Fence:** Depending on the depth, location, and local ordinances, a safety fence and appropriate signing may be required around the sediment basin.
- 89. Additional Considerations:** Sediment basins ~~which that~~ are more than 10 feet high, or which have storage capacities ~~in excess of above~~ 10 acre-feet may require review and approval from the Iowa DNR per IAC 567-71.3. A vast majority of temporary sediment basins will not fall under these regulations. Basins that are intended to become permanent features are more likely to require this review.

C. Application

- 1. Standalone Basins:** On some construction sites, sediment basins are installed as a temporary facility, separate from any permanent, post-construction, stormwater management facilities. In these situations, the sediment basin is installed and maintained during active grading operations and removed upon completion and permanent stabilization of the site.
- 2. Combination Stormwater Management / Sediment Basins:** Many residential or commercial subdivisions experience re-disturbance of the ground while individual lot grading and building construction take place. This intermittent disturbance can last several years until full build-out of the site is achieved. In these situations, it may be prudent to incorporate a temporary sediment basin within a permanent, post-construction, stormwater management facility.

This approach can be successfully implemented with careful planning and coordination with the developer, future owner(s), and jurisdiction concerning maintenance after initial grading and removal upon full buildout. The following should be considered:

- a. Outlet:** A perforated riser or skimmer device can be temporarily connected to the stormwater management outlet structure or the stormwater management outlet structure can be temporarily plugged and a separate outlet provided for the sediment control drawdown outlet.

b. Wet Storage: Regardless of the type of sediment control outlet provided, care must be taken to maintain the required “wet storage” volume in the bottom of the dry basin. A skimmer may need to be supported and the bottom of the dry basin may need to be over-excavated to provide this volume.

c. Overflow: Ensure that the emergency/auxiliary overflow is not impeded. The sediment control outlet will likely restrict discharge rates more than the normal stormwater management outlet control structure. This will result in increased ponding and a greater likelihood of engaging the emergency/auxiliary overflow during moderate to large storm events.

d. Removal: Upon completion of the development, the sediment control structure, accumulated sediment, and any temporary pipe plug must be removed. The stormwater management facility must be restored to its intended purpose, and the site stabilized.

It must be clear which party will be responsible for this work as it will likely fall upon someone other than the original contractor or developer. Generally, this will be the party responsible for the permanent ownership and maintenance of the stormwater management facility. These responsibilities must be clearly stated within any development agreements or purchase agreements.

~~a. Sediment basin volumes and dimensions should be sized according to the criteria in Section 7D-1. Sediment basins are normally required for disturbed drainage areas of 10 acres or greater.~~

D. Maintenance

Commented [REL[8]: Add stabilization of side slopes

Maintenance and cleanout frequencies for sediment basins depend greatly on the amount of precipitation and sediment load arriving at the basin. During inspections, the embankment should be reviewed for signs of seepage, settlement, or slumping. These problems should be repaired immediately. Sediment should be removed from the basin when it accumulates to one-half of the wet storage volume.

During sediment cleanout, trash should be removed from the basin, and the dewatering device and riser pipe should be checked and cleared of any accumulated debris.

E. Design Example

Assume a construction site has 12 acres of disturbed ground which drains to a common location. In addition, 8 acres of off-site area drains through the construction site. Due to site restrictions, the 8 acres of off-site drainage cannot be routed around the site. Design a temporary sediment basin, with an emergency spillway, to handle and treat the runoff from the ~~20~~20-acre site.

Solution:

- Basin Volume:** The Iowa DNR NPDES General Permit No. 2 requires a minimum storage volume of 3,600 cubic feet of storage per acre drained.

Therefore: 20 acres x 3,600 cf = 72,000 cf.

According to [Section 7D-1, D. 3](#), this volume should be split equally between wet and dry storage (36,000 cf each).

For the remaining calculations, assume that a basin has been sized and laid out to provide the following elevations:

Elevation A (Bottom of Basin) = 100
 Elevation B (Wet Storage) = 103.0
 Elevation C (Dry Storage) 105.0
 Elevation D (Invert of emergency spillway) = 106.5
 Elevation E (Top of embankment) = 108.5

2. **Size the Principal Spillway (Riser):** From TR-55, using the methods described in [Chapter 2 - Stormwater](#), assume the peak inflow from the ~~2-2~~-year, ~~24-24~~-hour storm is 41 cfs.

~~In order to~~ To determine the required diameter of the principal spillway, the available head elevation above the spillway must be determined. From the elevation information provided above, the principal spillway is at elevation 105.0, and the invert of the emergency spillway is at elevation 106.5. Based ~~up~~ on this, the allowable head is 1.5 feet (106.5-105.0).

The diameter of ~~the~~ principal spillway (riser) is found by trial and error process, with the weir and orifice equations:

Try a 24 inch diameter riser: (d=2 ft, A=3.14 ft²)

Weir Flow

$$Q = 10.5 \times d \times h^{\frac{3}{2}}$$

$$Q = 10.5 \times 2 \times 1.5^{\frac{3}{2}} = 39 \text{ cfs}$$

Orifice Flow

$$Q = 0.6 \times A \times \sqrt{2gh}$$

$$Q = 0.6 \times 3.14 \times \sqrt{2 \times 32.2 \times 1.5} = 19 \text{ cfs}$$

The lower flow rate (orifice) controls at 19 cfs. The design flow rate was 41 cfs; therefore, the proposed ~~24-24~~-inch riser is too small. Try a larger diameter.

Try a ~~36-36~~-inch diameter riser. (d=3', A=7.1 ft²)

Weir Flow

$$Q = 10.5 \times 3 \times 1.5^{\frac{3}{2}} = 58 \text{ cfs}$$

Orifice Flow

$$Q = 0.6 \times 7.1 \times \sqrt{2 \times 32.2 \times 1.5} = 42 \text{ cfs}$$

The lower flow rate (orifice) controls at 42 cfs. This is greater than the design flow. Select a ~~36-36~~-inch diameter riser pipe for the principal spillway.

3. **Size the Dewatering Orifice:** To dewater 36,000 cubic feet, the average discharge, Q_a , is found as follows:

$$Q_a = \frac{36,000}{6 \times 60 \times 60} = 1.7 \text{ cfs.}$$

Next, determine the average head acting on the perforations during dewatering. Assume a rectangular orifice extends from the lowest set of perforations at the wet storage elevation (103.0), up to the upper row of perforations, 3 inches below the principal spillway (105.0-0.25 = 104.75). Based upon this, the maximum head, h_p , is 2 feet (105-103) and the distance to the centroid of the orifice is 0.875 feet [(104.75-103)/2].

From Equation 7E-12.03, the average head acting on the openings is:

$$h_a = \frac{(h_p - h_c)}{2} = \frac{(2 - 0.875)}{2} = 0.56 \text{ feet}$$

Once the average head and average discharge are known, the total orifice area can be calculated from Equation 7E-12.04:

$$A = \frac{Q_a}{0.6 \times (2g \times h_a)^{1/2}} = \frac{1.7}{0.6 \times (2 \times 32.2 \times 0.56)^{1/2}} = 0.47 \text{ sf}$$

Several perforation configurations could provide this area. One feasible selection would be to provide 18, 2 1/4 inch holes in three rows (6 holes per row).

4. **Size the Emergency Spillway:** Since this basin will have an emergency spillway, the principal spillway (riser) was only designed only to carry the ~~2~~-year storm. Larger storms, which exceed the capacity of the principal spillway, will be carried by the emergency spillway. The emergency spillway will be designed to carry the ~~25~~-year storm event.

From TR-55, using the methods described in [Chapter 2 - Stormwater](#), assume the inflow from the ~~25~~-year storm is 99 cfs.

During high flow events, both the principal spillway and the emergency spillway will be bypassing flow from the basin. From step 2, the capacity of the principal spillway is 42 cfs. Therefore, from Equation 7E-12.05, the required capacity of the emergency spillway is as follows:

$$Q_e = Q_{25} - Q_p = 99 - 42 = 57 \text{ cfs}$$

The capacity of the emergency spillway must be at least 57 cfs. From the assumptions above, the difference in elevation between the invert of the emergency spillway, and the top of the embankment is 2 feet. Since a minimum of 1 foot must be provided between the design high-water elevation and the top of the embankment, 1 foot of head is available for discharge across the spillway.

From Table 7E-12.01, find the discharge (Q) that equals or exceeds the design value of 57 cfs. From the table, for 1-foot of head, move horizontally to the discharge value of 61 cfs. Moving vertically in the table, the corresponding width for a discharge of 61 cfs is 26 feet.

5. Design Example Summary:

Basin Volume: 72,000 cubic feet (split equally between wet and dry storage)

Principal Spillway Diameter: 36 inches

Dewatering Device: 18, 2 1/4 inch holes in 3 rows (6 holes per row)

Emergency Spillway Width: 26 feet